



HA-2620, HA-2622 HA-2625

Very Wideband,
Uncompensated Operational Amplifiers

March 1983

Features

- Gain Bandwidth Product ($A_v \geq 5$) 100MHz
- High Input Impedance 500M Ω
- Low Input Bias Current 1nA
- Low Input Offset Current 1nA
- Low Input Offset Voltage 0.5mV
- High Gain 150kV/V
- High Slew Rate 35V/ μ s
- Output Short Circuit Protection

Applications

- Video and R.F. Amplifier
- Pulse Amplifier
- Audio Amplifiers and Filters
- High-Q Active Filters
- High Speed Comparators
- Low Distortion Oscillator

Ordering Information

PART NUMBER	TEMPERATURE RANGE	PACKAGE
HA2-2620-2	-55°C to +125°C	8 Pin Can
HA2-2622-2	-55°C to +125°C	8 Pin Can
HA2-2625-5	0°C to +75°C	8 Pin Can
HA3-2625-5	0°C to +75°C	8 Lead Plastic DIP
HA4P2625-5	0°C to +75°C	20 Lead PLCC
HA7-2620-2	-55°C to +125°C	8 Lead Ceramic DIP
HA7-2622-2	-55°C to +125°C	8 Lead Ceramic DIP
HA7-2625-5	0°C to +75°C	8 Lead Ceramic DIP
HA9P2625-5	0°C to +75°C	8 Lead SOIC
HA9P2625-9	-40°C to +85°C	8 Lead SOIC

Description

HA-2620/2622/2625 are bipolar operational amplifiers that feature very high input impedance (500M Ω , HA-2620) coupled with wideband AC performance. The high resistance of the input stage is complemented by low offset voltage (0.5mV, HA-2620) and low bias and offset current (1nA, HA-2620) to facilitate accurate signal processing. Input offset can be reduced further by means of an external nulling potentiometer. The 100MHz gain bandwidth product (HA-2620/2622/2625 are stable for closed loop gains greater than 5), 35V/ μ s slew rate and 150kV/V open loop gain enables HA-2620/2622/2625 to perform high gain amplification of very fast, wideband signals. These dynamic characteristics, coupled with fast settling times, make these amplifiers ideally suited to pulse amplification designs as well as high frequency (e.g. video) applications. The frequency response of the amplifier can be tailored to exact design requirements by means of an external bandwidth control capacitor connected from the Comp pin to GND.

In addition to its application in pulse and video amplifier designs, HA-2620/2622/2625 is particularly suited to other high performance designs such as high-gain low distortion audio amplifiers, high-Q and wideband active filters and high-speed comparators. For more information, please refer to Application Notes 509, 519 and 546.

The HA-2620 and HA-2622 are both offered as /883 Military Grade with the HA-2622 also available in LCC packages. MIL-STD-883 data sheets are available upon request.

Pinouts

HA-2620/22 (CDIP)
HA-2528 (CDIP, PDIP, SOIC)
TOP VIEW

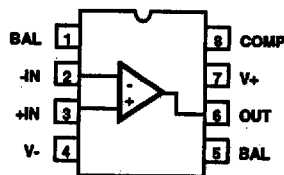

HA-2620, HA-2622, HA-2625
(CAN)
TOP VIEW

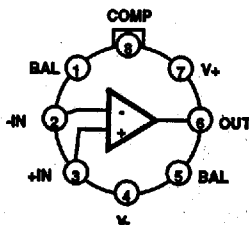

HA-2625, (PLCC)
TOP VIEW

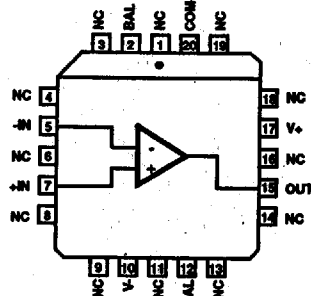

CAUTION: These devices are sensitive to electrostatic discharge. Users should follow proper I.C. Handling Procedures.
Copyright © Harris Corporation 1983

File Number 2903.1

Specifications HA-2620, HA-2622, HA-2625

Absolute Maximum Ratings

Supply Voltage (Between V+ and V- Terminals)	45V
Differential Input Voltage	12.0V
Peak Output Current	Full Short Circuit Protection
Junction Temperature	+175°C
Junction Temperature (Plastic Package)	+150°C
Lead Temperature (Soldering 10 Sec.)	+300°C

Operating Temperature Ranges

Operating Temperature Range	
HA-2620/HA-2622-2	-55°C ≤ T _A ≤ +125°C
HA-2625-5	0°C ≤ T _A ≤ +75°C
HA-2625-9	-40°C ≤ T _A ≤ +80°C
Storage Temperature Range	-65°C ≤ T _A ≤ +150°C

CAUTION: Stresses above those listed in "Absolute Maximum Ratings" may cause permanent damage to the device. This is a stress only rating and operation of the device at these or any other conditions above those indicated in the operational sections of this specification is not implied.

Electrical Specifications V_S = ±15VDC, Unless Otherwise Specified.

PARAMETER	TEMP	HA-2620-2			HA-2622-2			HA-2625-5, -9			UNITS
		MIN	TYP	MAX	MIN	TYP	MAX	MIN	TYP	MAX	
INPUT CHARACTERISTICS											
Offset Voltage (Note 1)	+25°C	-	0.5	4	-	3	5	-	3	5	mV
	Full	-	2	6	-	-	7	-	-	7	mV
Average Offset Voltage Drift	Full	-	5	-	-	5	-	-	5	-	μV/°C
Bias Current	+25°C	-	1	15	-	5	25	-	5	25	nA
	Full	-	10	35	-	-	60	-	-	40	nA
Offset Current	+25°C	-	1	15	-	5	25	-	5	25	nA
	Full	-	5	35	-	-	60	-	-	40	nA
Differential Input Resistance (Note 11)	+25°C	65	500	-	40	300	-	40	300	-	MΩ
Input Noise Voltage Density f = 1kHz	+25°C	-	11	-	-	11	-	-	11	-	nV/√Hz
Input Noise Current Density f = 1kHz	+25°C	-	0.16	-	-	0.16	-	-	0.16	-	pA/√Hz
Common Mode Range	Full	±11	±12	-	±11	±12	-	±11	±12	-	V
TRANSFER CHARACTERISTICS											
Large Signal Voltage Gain (Notes 2, 3)	+25°C	100	150	-	80	150	-	80	150	-	KV/V
	Full	70	-	-	60	-	-	70	-	-	KV/V
Common Mode Rejection Ratio (Note 4)	Full	80	100	-	74	100	-	74	100	-	dB
Minimum Stable Gain	+25°C	5	-	-	5	-	-	5	-	-	V/V
Gain Bandwidth Product (Notes 2, 5, 6)	+25°C	-	100	-	-	100	-	-	100	-	MHz

2
OPERATIONAL AMPLIFIERS

Specifications HA-2620, HA-2622, HA-2625

Electrical Specifications $V_S = \pm 15\text{VDC}$, Unless Otherwise Specified.

PARAMETER	TEMP	HA-2620-2			HA-2622-2			HA-2625-5, -9			UNITS
		MIN	TYP	MAX	MIN	TYP	MAX	MIN	TYP	MAX	
OUTPUT CHARACTERISTICS											
Output Voltage Swing (Note 2)	Full	± 10	± 12	-	± 10	± 12	-	± 10	± 12	-	V
Output Current (Note 3)	+25°C	± 15	± 22	-	± 10	± 18	-	± 10	± 18	-	mA
Full Power Bandwidth (Notes 2, 3, 7, 12)	+25°C	400	600	-	320	600	-	320	600	-	kHz
TRANSIENT RESPONSE (Note 8)											
Rise Time (Notes 2, 7, 8)	+25°C	-	17	45	-	17	45	-	17	45	ns
Slew Rate (Notes 2, 7, 8, 10)	+25°C	± 25	± 35	-	± 20	± 35	-	± 20	± 35	-	V/ μ s
POWER SUPPLY CHARACTERISTICS											
Supply Current	+25°C	-	3	3.7	-	3	4	-	3	4	mA
Power Supply Rejection Ratio (Note 9)	Full	80	90	-	74	90	-	74	90	-	dB

NOTES:

- Offset may be externally adjusted to zero.
- $R_L = 2\text{k}\Omega$.
- $V_{OUT} = \pm 10.0\text{V}$.
- $V_{CM} = \pm 10\text{V}$.
- $V_{OUT} < 90\text{mV}$.
- 40dB Gain.
- See Transient Response Test Circuits & Waveforms.
- $A_V = 5$ (The HA-2620 family is not stable at unity gain without external compensation).
- $\Delta V_S = \pm 5\text{V}$.
- $V_{OUT} = \pm 5\text{V}$.
- This parameter value guaranteed by design calculations.
- Full Power Bandwidth guaranteed by slew rate measurement: $\text{FPBW} = \frac{\text{Slew Rate}}{2 \times V_{\text{PEAK}}}$
- Absolute Maximum Ratings are limiting values applied individually beyond which the serviceability of the circuit may be impaired. Functional operation under any of these conditions is not necessarily implied.

HA-2620, HA-2622, HA-2625

Schematic Diagram

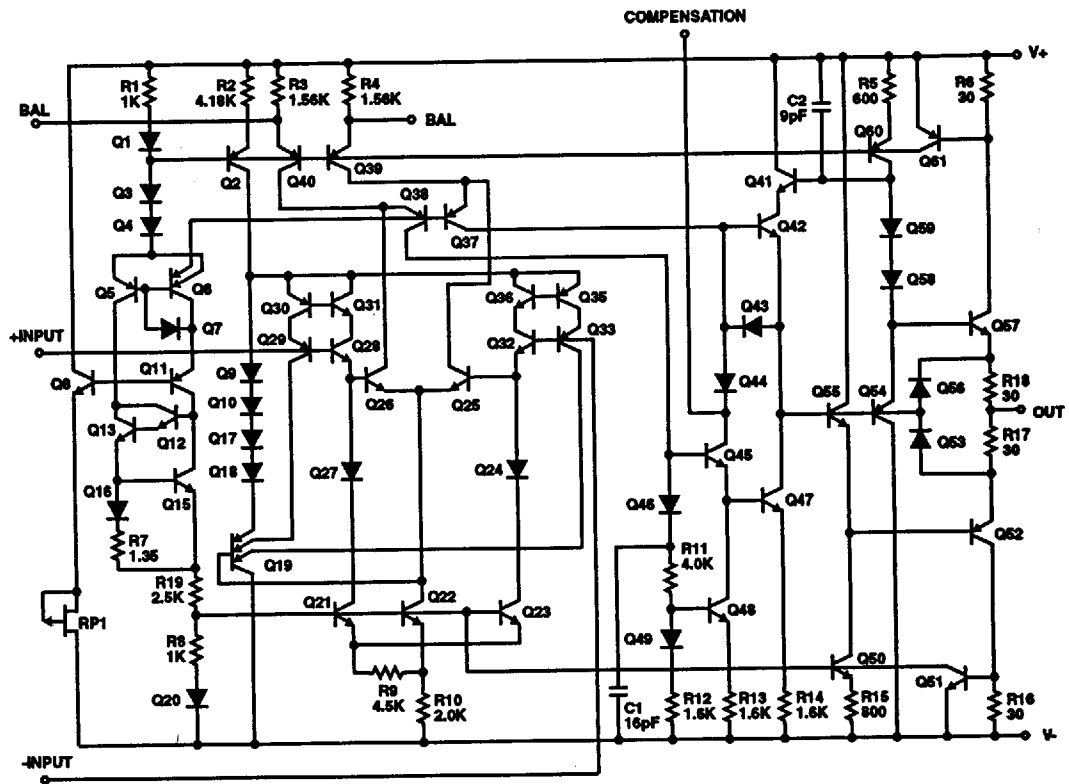

Die Characteristics

Transistor Count	140
Die Dimensions	73 x 52 x 19 mils
Substrate Potential	Unbiased

Thermal Constants (°C/W)	θ_{JA}	θ_{JC}
Metal Can	117	36
Plastic DIP	96	34
Ceramic DIP	115	36
SOIC	157	43
PLCC	74	33

2
OPERATIONAL AMPLIFIERS

Test Circuits

TRANSIENT RESPONSE

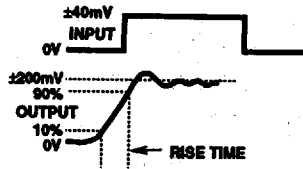

SLEW RATE

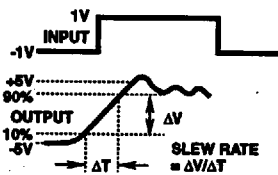

SLEW RATE AND TRANSIENT RESPONSE

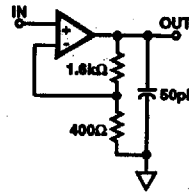

SUGGESTED V_{OS} ADJUSTMENT AND COMPENSATION HOOK-UP

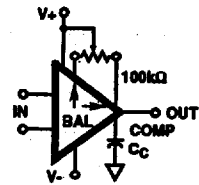

NOTE: Measured on both positive and negative transients from 0V to +200mV and 0V to -200mV at output.

Tested Offset Adjustment is $V_{OS} + 1mV$ minimum referred to output. Typical range is $\pm 10mV$ with $R_T = 100k\Omega$.

Typical Performance Curves $V_S = \pm 15VDC$, $T_A = +25^\circ C$, Unless Otherwise Specified.

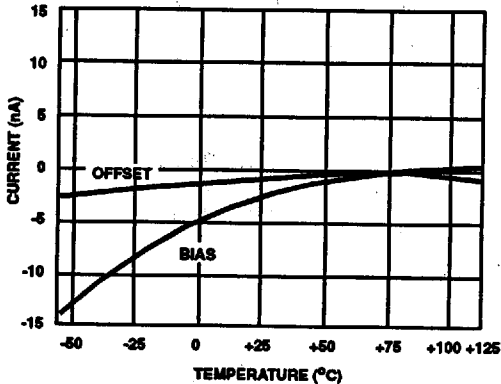

FIGURE 1. INPUT BIAS CURRENT AND OFFSET CURRENT vs TEMPERATURE

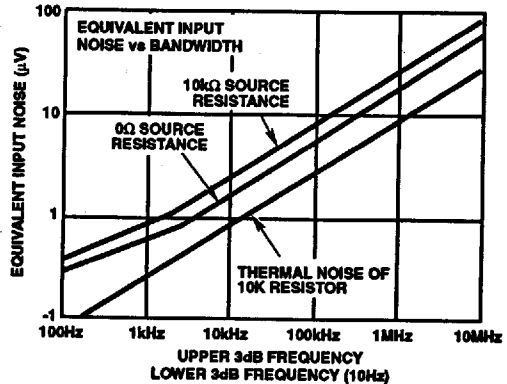

FIGURE 2. BROADBAND NOISE CHARACTERISTICS

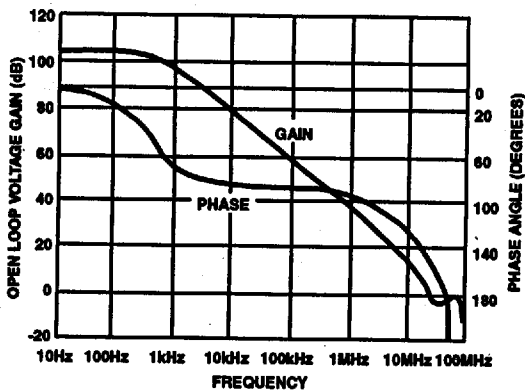

FIGURE 3. OPEN LOOP FREQUENCY AND PHASE RESPONSE

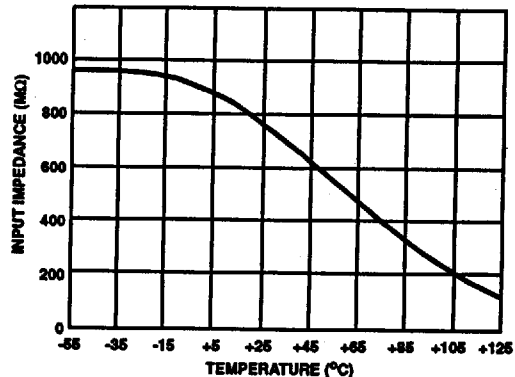

FIGURE 4. INPUT IMPEDANCE vs TEMPERATURE, 100Hz

HA-2620, HA-2622, HA-2625

Typical Performance Curves $V_S = \pm 15VDC$, $T_A = +25^\circ C$, Unless Otherwise Specified. (Continued)

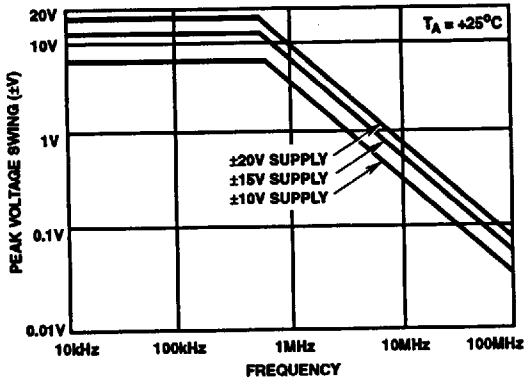

FIGURE 5. OUTPUT VOLTAGE SWING vs FREQUENCY

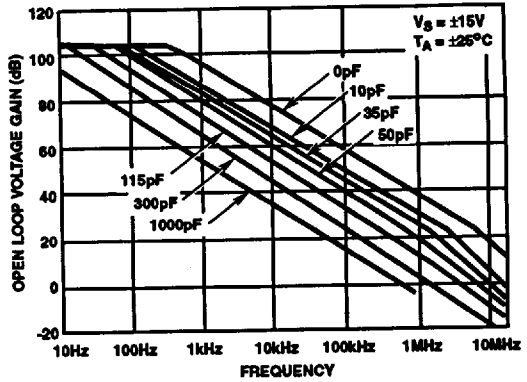

FIGURE 6. OPEN LOOP FREQUENCY RESPONSE FOR VARIOUS VALUES OF CAPACITORS FROM COMP. PIN TO GND

NOTE: External Compensation is required for closed loop gain < 5. If external compensation is used, also connect 100pF capacitor from output to ground.

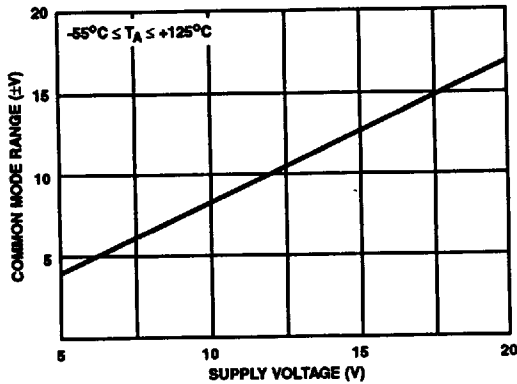

FIGURE 7. COMMON MODE VOLTAGE RANGE vs SUPPLY VOLTAGE

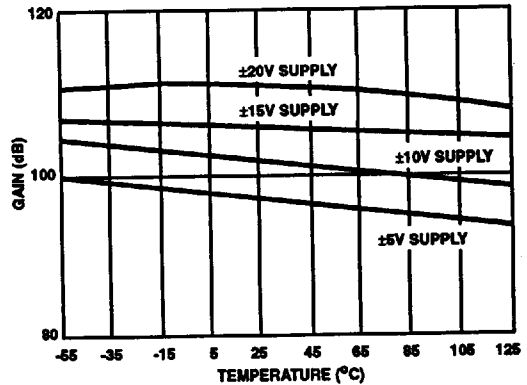

FIGURE 8. OPEN LOOP VOLTAGE GAIN vs TEMPERATURE

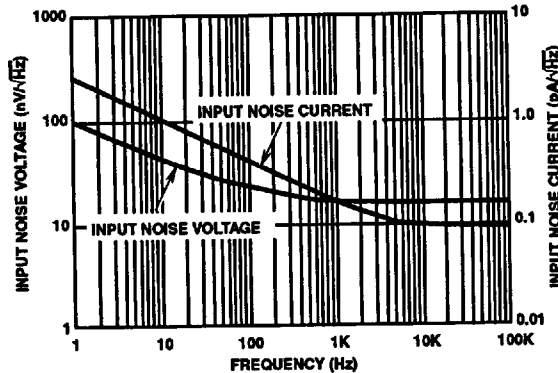

FIGURE 9. NOISE DENSITY vs FREQUENCY

Typical Applications

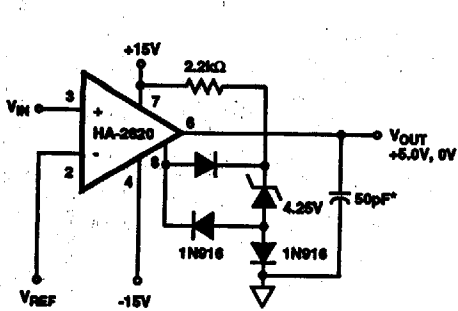

FIGURE 10. HIGH IMPEDANCE COMPARATOR

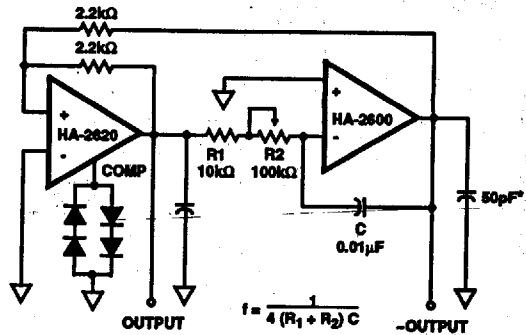
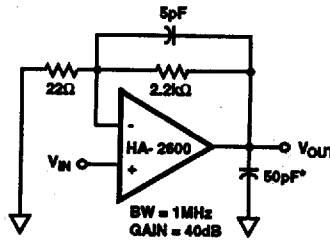

FIGURE 11. FUNCTION GENERATOR



*A small load capacitance of at least 30pF (including stray capacitance) is recommended to prevent possible high frequency oscillations.

FIGURE 12. VIDEO AMPLIFIER