

3.1W, Mono, Fully Differential Audio Power Amplifier with Internal Feedback Resistors

www.datasheet4u.com

General Description

The CP2297 is a fully differential audio power amplifier designed for demanding audio applications. It is capable of delivering 3.1 watt of continuous average power to a 3Ω BTL load with less than 10% distortion (THD+N) from a 5V battery voltage. It operates from 2.2V to 5.5V.

Features like -86dB PSRR at 217Hz, improved RF-rectification immunity, the space-saving CSP9, DFN8, MSOP8 and SOP8-PP(EXP PAD) packages, the advanced pop & click circuitry, a minimal count of external components and low-power shutdown mode make the CP2297 ideal for wireless handsets.

The CP2297 is unity-gain stable, and the gain can be configured by external input resistors and internal feedback resistors.



CSP9 Package
1.5mm x 1.5mm
-40°C ~ 85°C



DFN8 Package
3mm x 3mm
-40°C ~ 85°C



MSOP8 Package
-40°C ~ 85°C

Features

- Fully differential amplifier
- Improved PSRR at 217Hz
- Power output at 5.0V, 10% THD, 3 Ω (DFN8, SOP8-PP only)
- Power output at 5.0V, 1% THD, 8 Ω
- Ultra low shutdown current
- Improved pop & click circuitry eliminates noises during turn-on and turn-off transitions
- Thermal overload protection circuitry
- Unity-gain stable
- External gain configuration capability
- Available in space-saving packages: CSP9, DFN8, MSOP8 and SOP8-PP(EXP PAD)
- RoHS compliant and 100% lead(Pb)-free

-86dB (typ)
3.1W (typ)
1.36W (typ)
0.01μA (typ)

Applications

- Wireless handsets
- Portable audio devices
- PDAs
- Notebook computers

3.1W, Mono, Fully Differential Audio Power Amplifier with Internal Feedback Resistors

www.datasheet4u.com

Pin Configurations

**CSP9 Package
(Top View)**

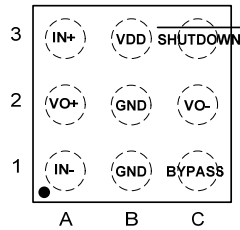

CSP9 Marking

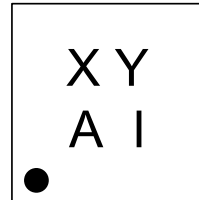

XY -Manufacture Date Code
AI - CP2297ITLX

**DFN8 Package
(Top View)**

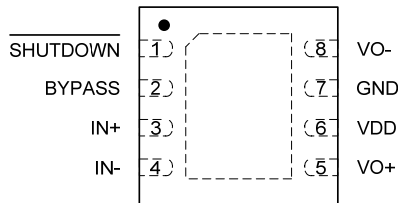

DFN8 Marking

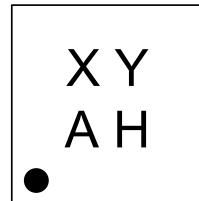

XY -Manufacture Date Code
AH - CP2297LD

**MSOP8 Package
(Top View)**

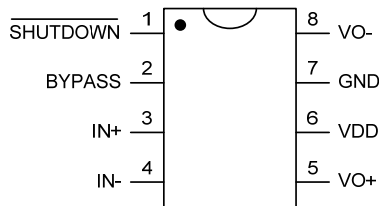

MSOP8 Marking

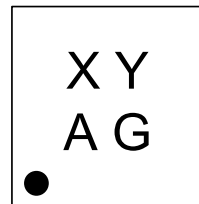

XY -Manufacture Date Code
AG - CP2297MM

**SOP8-PP Package
(Top View)**

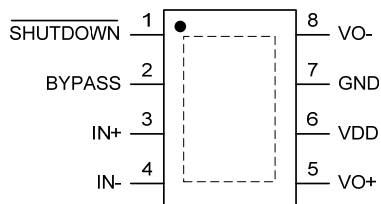

SOP8-PP Marking

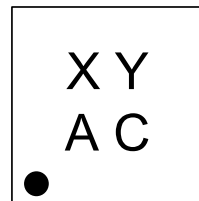

XY -Manufacture Date Code
AC - CP2297SP

3.1W, Mono, Fully Differential Audio Power Amplifier with Internal Feedback Resistors

Typical Application

www.datasheet4u.com

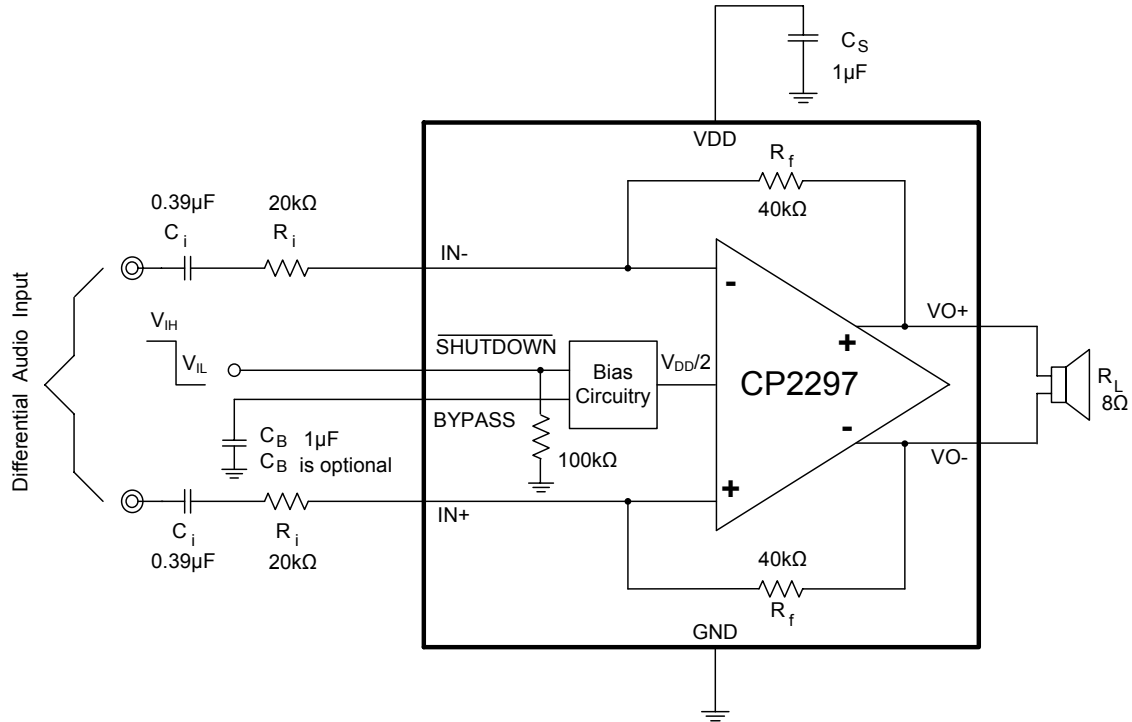

Contact with Chiphomer

4F, Building D, 1618 Yishan Road Shanghai, 201103, P.R.C.

Tel: (86)21-64014543 64058488

Fax: (86)21-64050030

Sale: sales@chiphomer.com

Technical support: support@chiphomer.com

Web site: www.chiphomer.com

Shenzhen Office:

10D, Building 2, Dushi Yangguang Garden CheGongMiao, Futian District, Shenzhen, 518048, P.R.C.

Tel: (86)755-82046706 82047789

Fax: (86)755-8204670