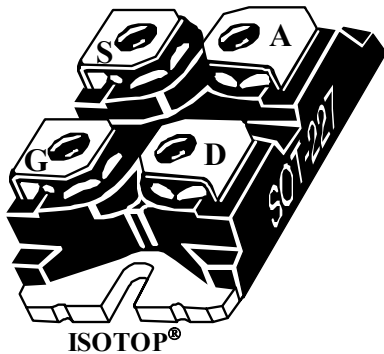
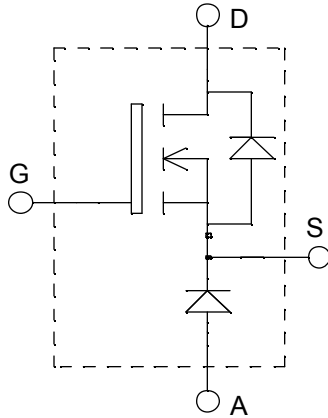

**ISOTOP[®] Buck chopper
MOSFET Power Module**

$V_{DSS} = 500V$
 $R_{DSon} = 75m\Omega \text{ max @ } T_j = 25^\circ C$
 $I_D = 51A \text{ @ } T_c = 25^\circ C$

Application

- AC and DC motor control
- Switched Mode Power Supplies

Features

- Power MOS 7[®] MOSFETs
 - Low R_{DSon}
 - Low input and Miller capacitance
 - Low gate charge
 - Fast intrinsic reverse diode
 - Avalanche energy rated
 - Very rugged
- ISOTOP[®] Package (SOT-227)
- Very low stray inductance
- High level of integration

Benefits

- Outstanding performance at high frequency operation
- Direct mounting to heatsink (isolated package)
- Low junction to case thermal resistance
- Very rugged
- Low profile
- RoHS Compliant

Absolute maximum ratings

Symbol	Parameter	Max ratings	Unit	
V_{DSS}	Drain - Source Breakdown Voltage	500	V	
I_D	Continuous Drain Current	$T_c = 25^\circ C$	51	
		$T_c = 80^\circ C$	39	
I_{DM}	Pulsed Drain current	204	A	
V_{GS}	Gate - Source Voltage	± 30	V	
R_{DSon}	Drain - Source ON Resistance	75	m Ω	
P_D	Maximum Power Dissipation	$T_c = 25^\circ C$	290	
I_{AR}	Avalanche current (repetitive and non repetitive)	51	A	
E_{AR}	Repetitive Avalanche Energy	50	mJ	
E_{AS}	Single Pulse Avalanche Energy	2500		
I_{FAV}	Maximum Average Forward Current	Duty cycle=0.5	$T_c = 80^\circ C$	A
I_{FRMS}	RMS Forward Current (Square wave, 50% duty)		39	

 **CAUTION:** These Devices are sensitive to Electrostatic Discharge. Proper Handling Procedures Should Be Followed.

All ratings @ $T_j = 25^\circ\text{C}$ unless otherwise specified

Electrical Characteristics

Symbol	Characteristic	Test Conditions	Min	Typ	Max	Unit
I_{DSS}	Zero Gate Voltage Drain Current	$V_{GS} = 0\text{V}, V_{DS} = 500\text{V}$			100	μA
		$V_{GS} = 0\text{V}, V_{DS} = 400\text{V}$			500	
$R_{DS(on)}$	Drain – Source on Resistance	$V_{GS} = 10\text{V}, I_D = 25.5\text{A}$			75	$\text{m}\Omega$
$V_{GS(th)}$	Gate Threshold Voltage	$V_{GS} = V_{DS}, I_D = 1\text{mA}$	3		5	V
I_{GSS}	Gate – Source Leakage Current	$V_{GS} = \pm 20\text{V}, V_{DS} = 0\text{V}$			± 100	nA

Dynamic Characteristics

Symbol	Characteristic	Test Conditions	Min	Typ	Max	Unit
C_{iss}	Input Capacitance	$V_{GS} = 0\text{V}$ $V_{DS} = 25\text{V}$ $f = 1\text{MHz}$		5590		pF
C_{oss}	Output Capacitance			1180		
C_{rss}	Reverse Transfer Capacitance			85		
Q_g	Total gate Charge	$V_{GS} = 10\text{V}$ $V_{Bus} = 250\text{V}$ $I_D = 51\text{A}$		123		nC
Q_{gs}	Gate – Source Charge			33		
Q_{gd}	Gate – Drain Charge			65		
$T_{d(on)}$	Turn-on Delay Time	Resistive Switching $V_{GS} = 15\text{V}$ $V_{Bus} = 250\text{V}$ $I_D = 51\text{A}$ $R_G = 0.6\Omega$		10		ns
T_r	Rise Time			20		
$T_{d(off)}$	Turn-off Delay Time			21		
T_f	Fall Time			5		
Eon	Turn-on Switching Energy	Inductive switching @ 25°C $V_{GS} = 15\text{V}, V_{Bus} = 330\text{V}$ $I_D = 51\text{A}, R_G = 5\Omega$		755		μJ
Eoff	Turn-off Switching Energy			726		
Eon	Turn-on Switching Energy	Inductive switching @ 125°C $V_{GS} = 15\text{V}, V_{Bus} = 330\text{V}$ $I_D = 51\text{A}, R_G = 5\Omega$		1241		μJ
Eoff	Turn-off Switching Energy			846		

Chopper diode ratings and characteristics

Symbol	Characteristic	Test Conditions	Min	Typ	Max	Unit
V_F	Diode Forward Voltage	$I_F = 30A$		1.6	1.8	V
		$I_F = 60A$		1.9		
		$I_F = 30A$ $T_j = 125^\circ C$		1.4		
I_{RM}	Maximum Reverse Leakage Current	$V_R = 600V$ $T_j = 25^\circ C$			250	μA
		$V_R = 600V$ $T_j = 125^\circ C$			500	
C_T	Junction Capacitance	$V_R = 200V$		44		pF
t_{rr}	Reverse Recovery Time	$I_F = 1A, V_R = 30V$ $di/dt = 100A/\mu s$	$T_j = 25^\circ C$	23		ns
	Reverse Recovery Time		$T_j = 25^\circ C$	85		
I_{RRM}	Maximum Reverse Recovery Current	$I_F = 30A$ $V_R = 400V$ $di/dt = 200A/\mu s$	$T_j = 125^\circ C$	160		A
			$T_j = 25^\circ C$	4		
Q_{rr}	Reverse Recovery Charge		$T_j = 125^\circ C$	8		nC
			$T_j = 25^\circ C$	130		
t_{rr}	Reverse Recovery Time	$I_F = 30A$	$T_j = 125^\circ C$	70		ns
Q_{rr}	Reverse Recovery Charge	$V_R = 400V$	$T_j = 125^\circ C$	1300		nC
I_{RRM}	Maximum Reverse Recovery Current	$di/dt = 1000A/\mu s$		30		A

Thermal and package characteristics

Symbol	Characteristic		Min	Typ	Max	Unit
R_{thJC}	Junction to Case Thermal Resistance	MOSFET			0.27	$^\circ C/W$
		Diode			1.21	
R_{thJA}	Junction to Ambient (IGBT & Diode)				20	
V_{ISOL}	RMS Isolation Voltage, any terminal to case $t = 1$ min, $I_{isol} < 1mA$, 50/60Hz		2500			V
T_j, T_{STG}	Storage Temperature Range		-55		150	$^\circ C$
T_L	Max Lead Temp for Soldering: 0.063" from case for 10 sec				300	
Torque	Mounting torque (Mounting = 8-32 or 4mm Machine and terminals = 4mm Machine)				1.5	N.m
Wt	Package Weight			29.2		g

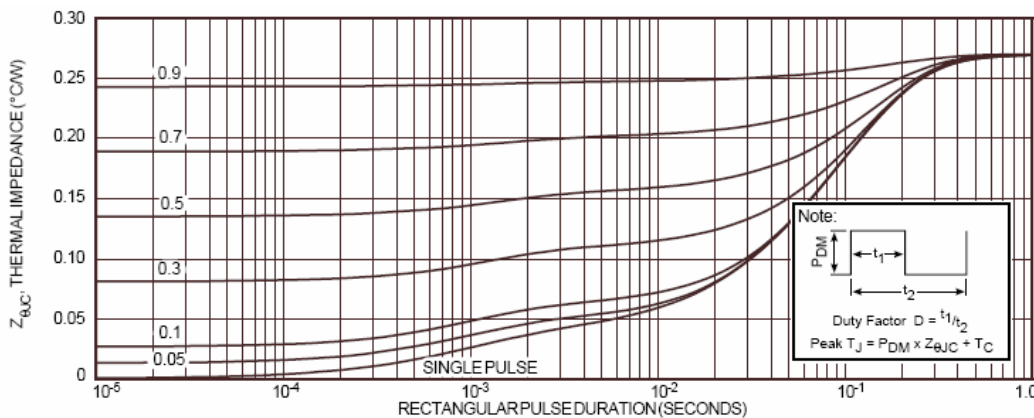
Typical MOSFET Performance Curve

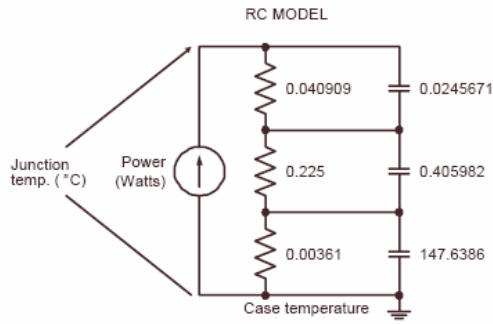

FIGURE 2, TRANSIENT THERMAL IMPEDANCE MODEL

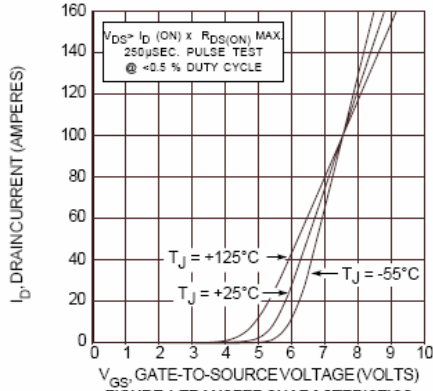

FIGURE 4, TRANSFER CHARACTERISTICS

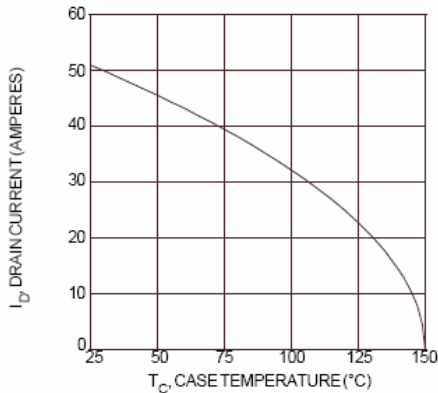

FIGURE 6, MAXIMUM DRAIN CURRENT vs CASE TEMPERATURE

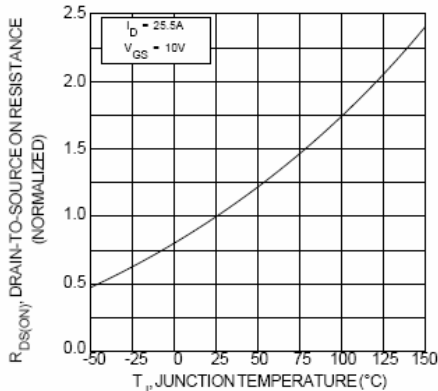

FIGURE 8, $R_{DS(ON)}$ vs. TEMPERATURE

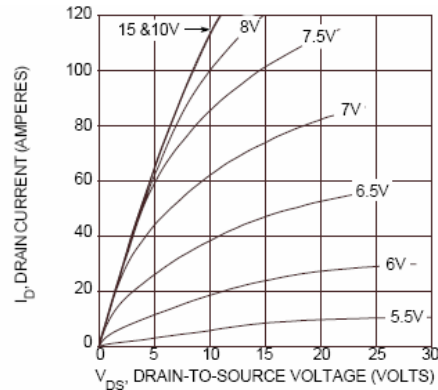

FIGURE 3, LOW VOLTAGE OUTPUT CHARACTERISTICS

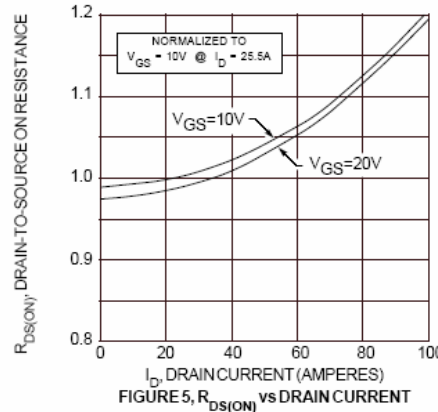

FIGURE 5, $R_{DS(ON)}$ vs DRAIN CURRENT

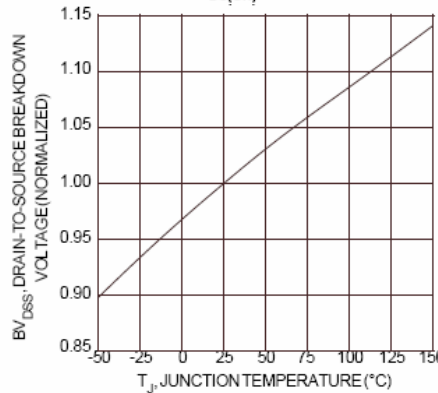

FIGURE 7, BREAKDOWN VOLTAGE vs TEMPERATURE

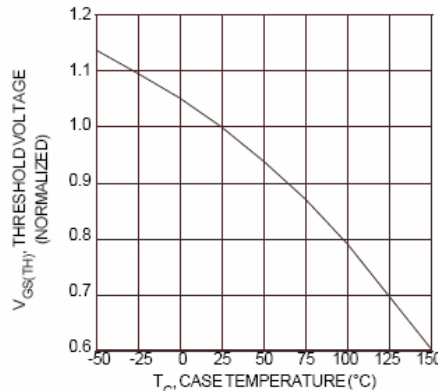

FIGURE 9, THRESHOLD VOLTAGE vs TEMPERATURE

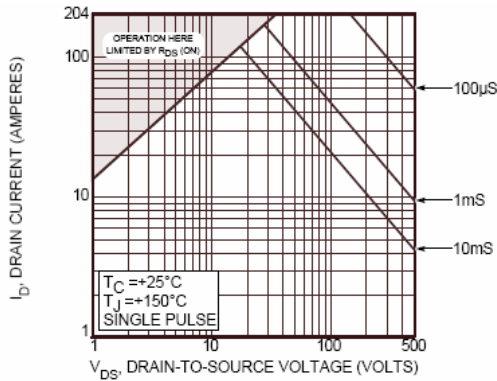

FIGURE 10, MAXIMUM SAFE OPERATING AREA

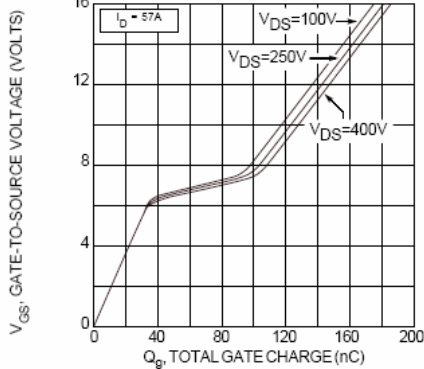

FIGURE 12, GATE CHARGE vs GATE-TO-SOURCE VOLTAGE

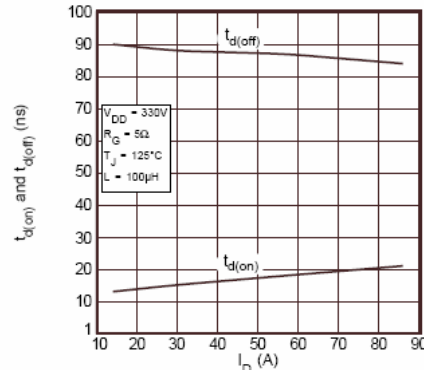

FIGURE 14, DELAY TIMES vs CURRENT

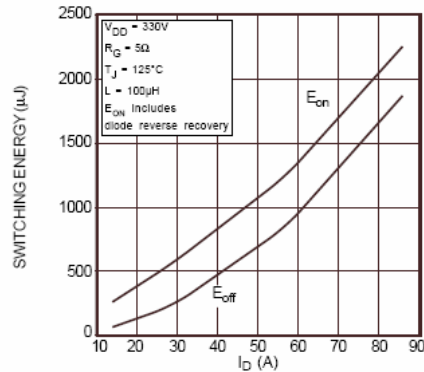

FIGURE 16, SWITCHING ENERGY vs CURRENT

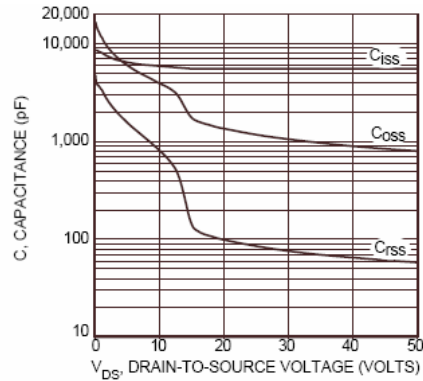

FIGURE 11, CAPACITANCE vs DRAIN-TO-SOURCE VOLTAGE

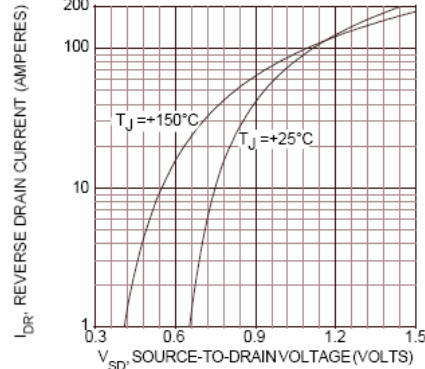

FIGURE 13, SOURCE-DRAIN DIODE FORWARD VOLTAGE

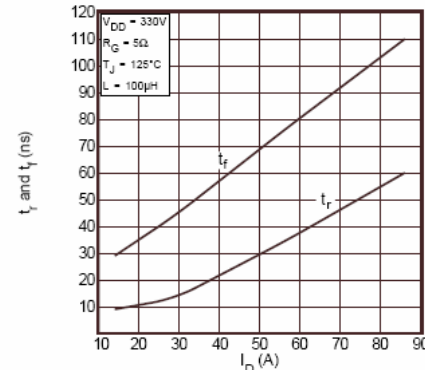

FIGURE 15, RISE AND FALL TIMES vs CURRENT

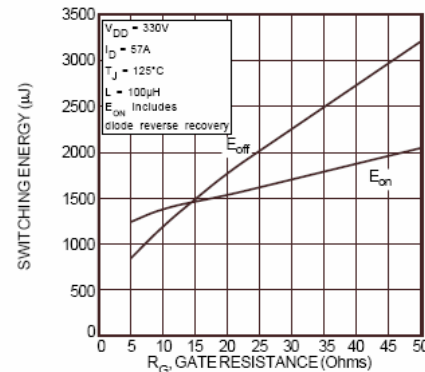

FIGURE 17, SWITCHING ENERGY vs. GATE RESISTANCE

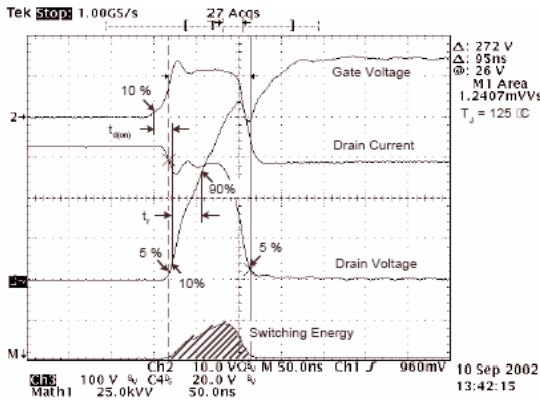

Figure 18, Turn-on Switching Waveforms and Definitions

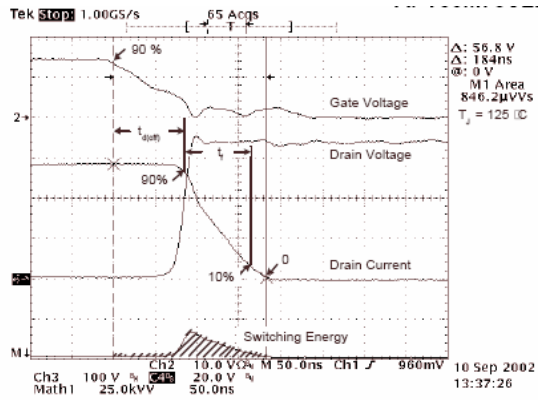

Figure 19, Turn-off Switching Waveforms and Definitions

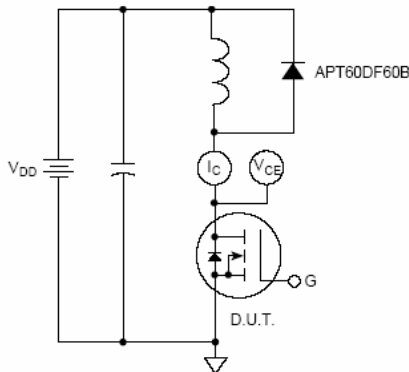

Figure 20, Inductive Switching Test Circuit

Typical Diode Performance Curve

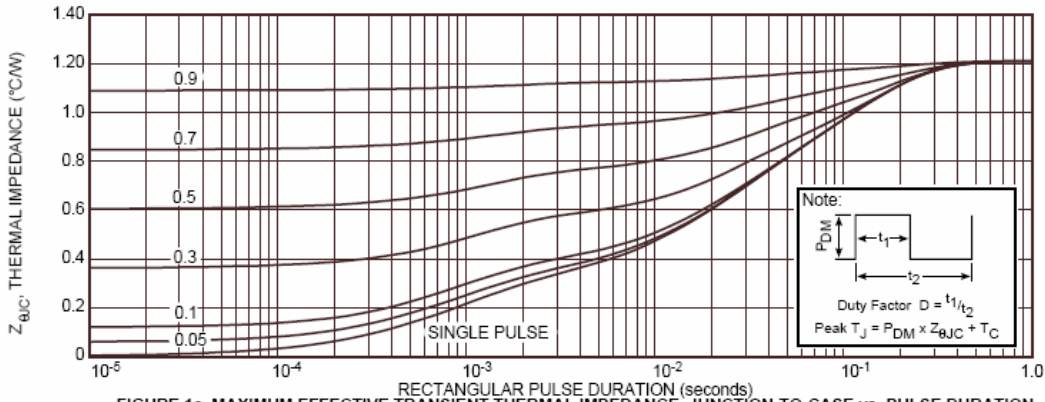

FIGURE 1a. MAXIMUM EFFECTIVE TRANSIENT THERMAL IMPEDANCE, JUNCTION-TO-CASE vs. PULSE DURATION

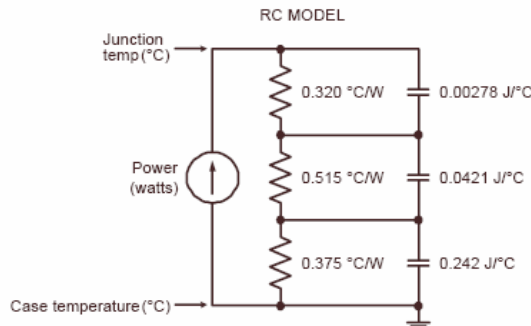

FIGURE 1b, TRANSIENT THERMAL IMPEDANCE MODEL

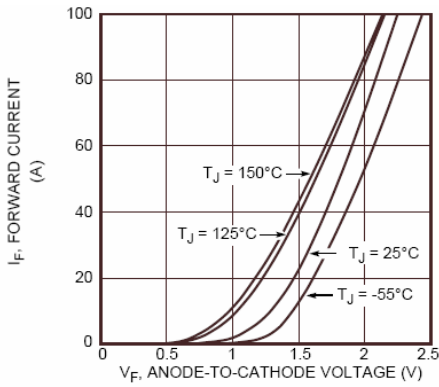

Figure 2. Forward Current vs. Forward Voltage

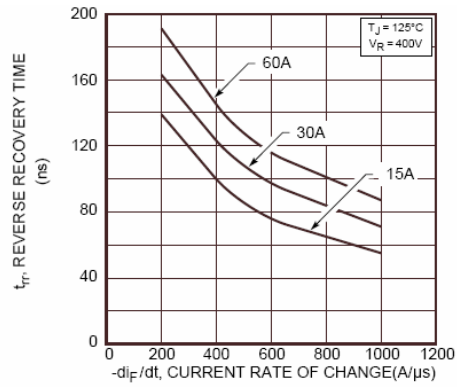

Figure 3. Reverse Recovery Time vs. Current Rate of Change

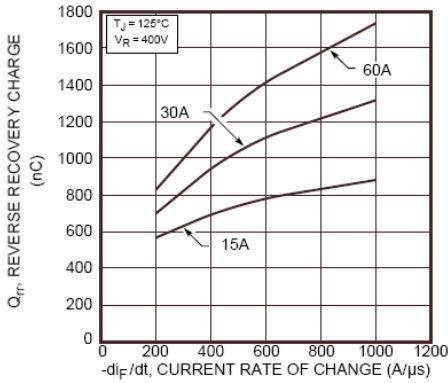

Figure 4. Reverse Recovery Charge vs. Current Rate of Change

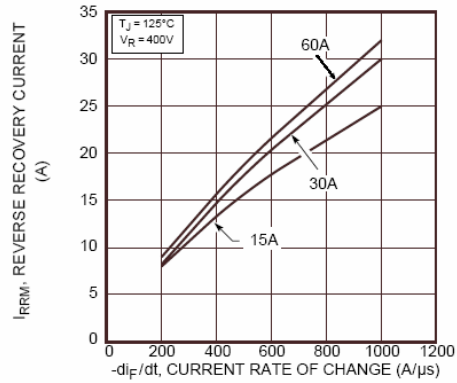

Figure 5. Reverse Recovery Current vs. Current Rate of Change

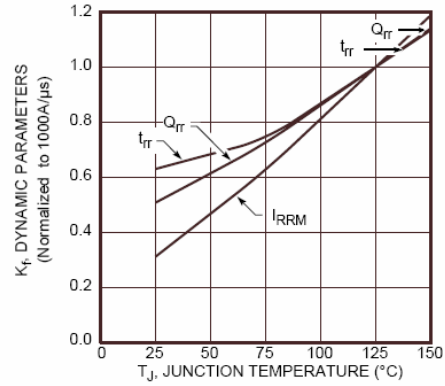

Figure 6. Dynamic Parameters vs. Junction Temperature

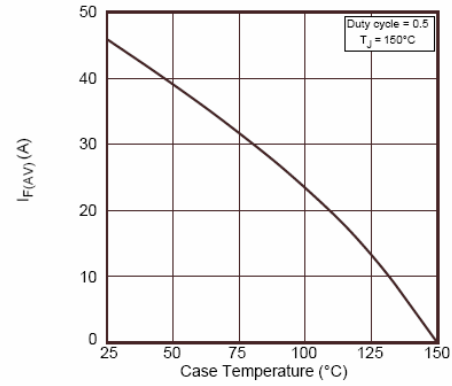

Figure 7. Maximum Average Forward Current vs. Case Temperature

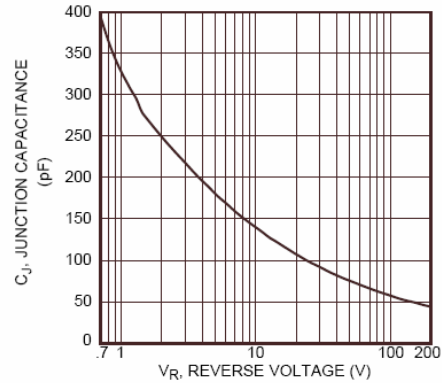

Figure 8. Junction Capacitance vs. Reverse Voltage

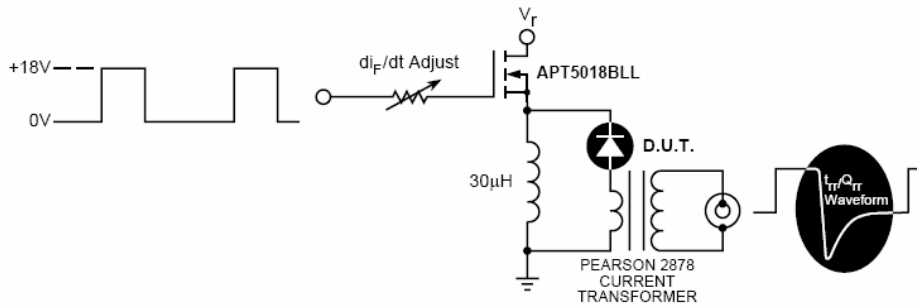

Figure 9. Diode Test Circuit

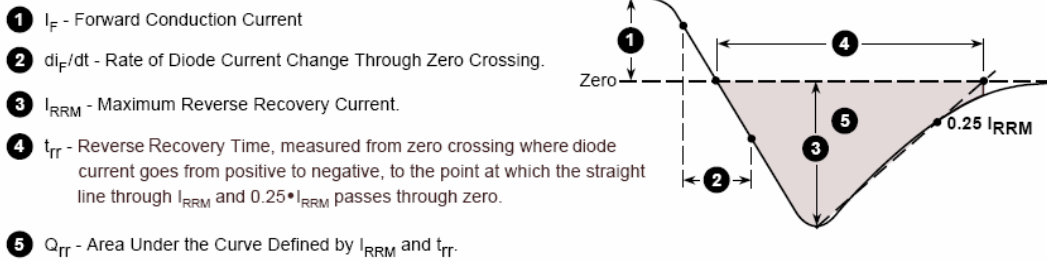
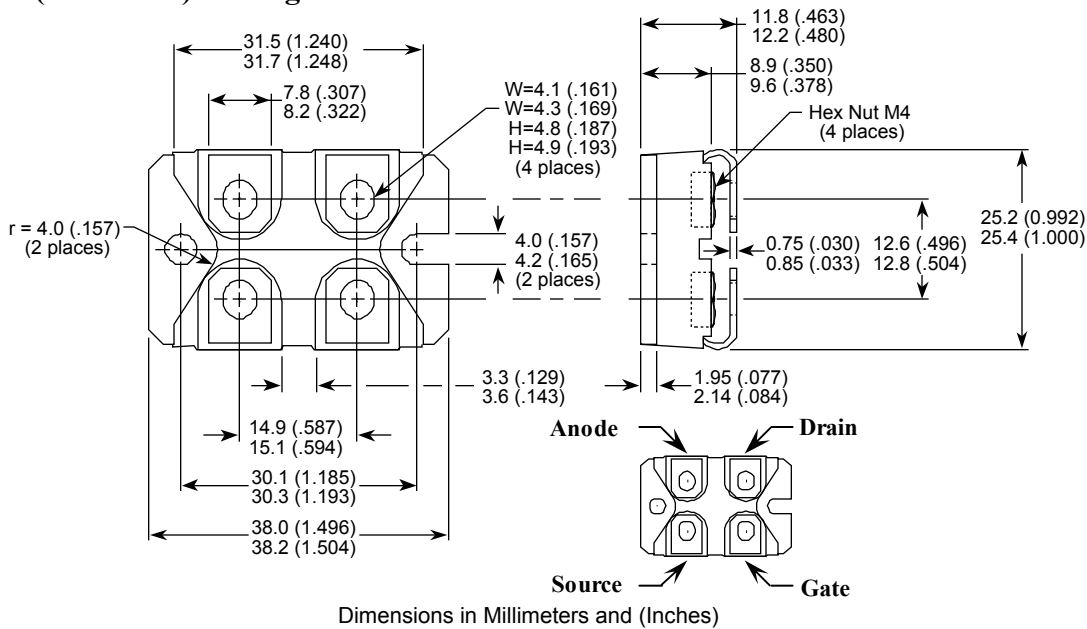

Figure 10. Diode Reverse Recovery Waveform and Definitions

SOT-227 (ISOTOP[®]) Package Outline



ISOTOP[®] is a registered trademark of ST Microelectronics NV

Microsemi reserves the right to change, without notice, the specifications and information contained herein

Microsemi's products are covered by one or more of U.S. patents 4,895,810 5,045,903 5,089,434 5,182,234 5,019,522 5,262,336 6,503,786 5,256,583 4,748,103 5,283,202 5,231,474 5,434,095 5,528,058 and foreign patents. U.S. and Foreign patents pending. All Rights Reserved.