

BIPOLAR ANALOG INTEGRATED CIRCUITS

μ PC78M00A SERIES

THREE TERMINAL POSITIVE VOLTAGE REGULATORS

DESCRIPTION

μ PC78M00A series are monolithic three terminal positive regulators which employ internally current limiting, thermal shut down, output transistor safe operating area protection make them essentially indestructible.

They are improved for load regulation, as comparison of conventional μ PC78M00 series.

FEATURES

- Wide operation temperature range.
- Good regulation (line, load).
- Built-in some protection circuits.
(over current protection, SOA protection and thermal shut down)

ORDER INFORMATION

TYPE NUMBER	OUTPUT VOLTAGE	PACKAGE	QUALITY GRADE
μ PC78M05AHF	5 V	MP-45G (ISOLATED TO-220)	Standard
μ PC78M06AHF	6 V		
μ PC78M07AHF	7 V		
μ PC78M08AHF	8 V		
μ PC78M09AHF	9 V		
μ PC78M10AHF	10 V		
μ PC78M12AHF	12 V		
μ PC78M15AHF	15 V		
μ PC78M18AHF	18 V		
μ PC78M24AHF	24 V		

Please refer to "Quality grade on NEC Semiconductor Devices" (Document number IEI-1209) published by NEC Corporation to know the specification of quality grade on the devices and its recommended applications.

EQUIVALENT CIRCUIT

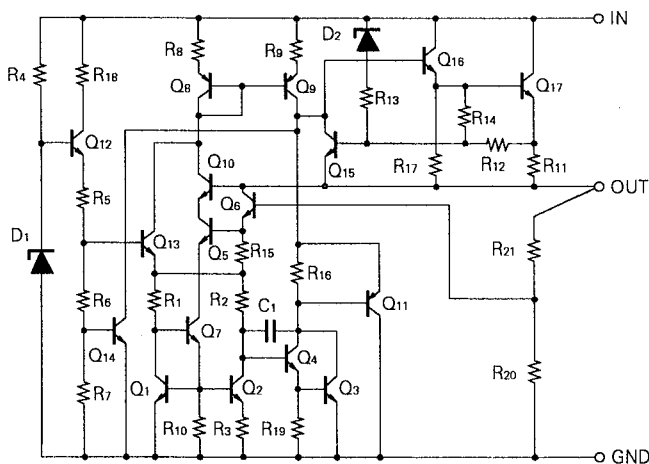

CONNECTION DIAGRAM

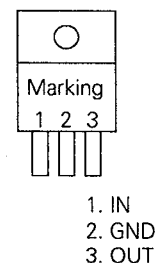

ABSOLUTE MAXIMUM RATINGS (T_a = 25 °C)

CHARACTERISTIC	SYMBOL	RATING	UNIT
Input Voltage	V _{IN}	35/40 (Note1)	V
Internal Power Dissipation	P _T	15 (Note2)	W
Operating Ambient Temperature Range	T _{opt}	- 30 to + 85	°C
Operating Junction Temperature Range	T _{opt(j)}	- 30 to + 150	°C
Storage Temperature Range	T _{stg}	- 55 to + 150	°C
Thermal Resistance (junction to case)	R _{th(j-c)}	7	°C/W
Thermal Resistance (junction to ambient)	R _{th(j-a)}	65	°C/W

(Note1) μPC78M05A, 06, 07, 08, 09, 10, 12, 15, 18 : 35 V, μPC78M24A : 40 V

(Note2) Internally limited

TYPICAL CONNECTION

www.DataSheet4U.com

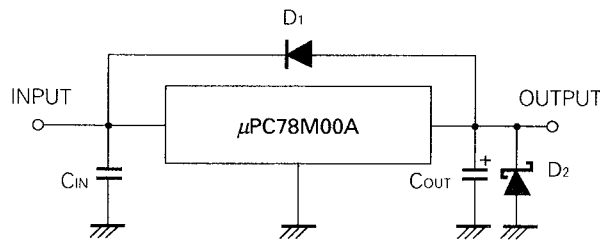

C₁: Required if regulator is located an appreciable distance from power supply filter.

C₂: More than 0.1 μF

D₁: Needed for V_{IN} < V_o

D₂: Needed for V_o < GND

RECOMMENDED OPERATING CONDITIONS

CHARACTERISTIC	SYMBOL		MIN.	TYP.	MAX.	UNIT
Input Voltage	V _{IN}	μPC78M05AHF	7	10	25	V
		μPC78M06AHF	8.5	11	25	
		μPC78M07AHF	9.5	12	25	
		μPC78M08AHF	10.5	14	25	
		μPC78M09AHF	11.5	15	25	
		μPC78M10AHF	12.5	17	28	
		μPC78M12AHF	14.5	19	30	
		μPC78M15AHF	17.5	23	30	
		μPC78M18AHF	21	27	30	
		μPC78M24AHF	27	33	38	
Output Current	I _o	All	5		350	mA
Operating Junction Temperature Range	T _{opt(j)}	All	- 30		+ 125	°C

ELECTRICAL CHARACTERISTICS μPC78M05A

($V_{IN} = 10\text{ V}$, $I_o = 350\text{ mA}$, $0\text{ °C} \leq T_j \leq +125\text{ °C}$)

CHARACTERISTIC	SYMBOL	TEST CONDITIONS	MIN.	TYP.	MAX.	UNIT
Output Voltage	V_o	$T_j = 25\text{ °C}$	4.8	5.0	5.2	V
		$7\text{ V} \leq V_{IN} \leq 20\text{ V}$, $5\text{ mA} \leq I_o \leq 350\text{ mA}$	4.75		5.25	
		$-30\text{ °C} \leq T_j \leq +125\text{ °C}$	4.75		5.25	
Line Regulation	REG _{IN}	$T_j = 25\text{ °C}$, $7\text{ V} \leq V_{IN} \leq 25\text{ V}$, $I_o = 200\text{ mA}$		3	20	mV
		$T_j = 25\text{ °C}$, $8\text{ V} \leq V_{IN} \leq 25\text{ V}$, $I_o = 200\text{ mA}$		1	15	
Load Regulation	REG _L	$T_j = 25\text{ °C}$, $5\text{ mA} \leq I_o \leq 500\text{ mA}$		3	20	mV
		$T_j = 25\text{ °C}$, $5\text{ mA} \leq I_o \leq 200\text{ mA}$		1	10	
Quiescent Current	I _{BIAS}	$T_j = 25\text{ °C}$		4	6.0	mA
Quiescent Current Change	ΔI_{BIAS}	$8\text{ V} \leq V_{IN} \leq 25\text{ V}$, $I_o = 200\text{ mA}$			0.8	mA
		$5\text{ mA} \leq I_o \leq 350\text{ mA}$			0.5	
Output Noise Voltage	V_n	$T_j = 25\text{ °C}$, $10\text{ Hz} \leq f \leq 100\text{ kHz}$		40		μV _{r.m.s.}
Ripple Rejection	R•R	$T_j = 25\text{ °C}$, $f = 120\text{ Hz}$, $8\text{ V} \leq V_{IN} \leq 18\text{ V}$, $I_o = 300\text{ mA}$	68	84		dB
Dropout Voltage	V _{DIF}	$T_j = 25\text{ °C}$		2.0		V
Short Circuit Current	I _o short	$T_j = 25\text{ °C}$, $V_{IN} = 35\text{ V}$		430		mA
Peak Output Current	I _o peak	$T_j = 25\text{ °C}$		1.0		A
Temperature Coefficient of Output Voltage	$\Delta V_o/\Delta T$	$I_o = 5\text{ mA}$		-0.8		mV/°C

ELECTRICAL CHARACTERISTICS μPC78M06A

($V_{IN} = 11\text{ V}$, $I_o = 350\text{ mA}$, $0\text{ °C} \leq T_j \leq +125\text{ °C}$)

CHARACTERISTIC	SYMBOL	TEST CONDITIONS	MIN.	TYP.	MAX.	UNIT
Output Voltage	V_o	$T_j = 25\text{ °C}$	5.76	6.0	6.24	V
		$8.5\text{ V} \leq V_{IN} \leq 21\text{ V}$, $5\text{ mA} \leq I_o \leq 350\text{ mA}$	5.7		6.3	
		$-30\text{ °C} \leq T_j \leq +125\text{ °C}$	5.7		6.3	
Line Regulation	REG _{IN}	$T_j = 25\text{ °C}$, $8.5\text{ V} \leq V_{IN} \leq 25\text{ V}$, $I_o = 200\text{ mA}$		4	20	mV
		$T_j = 25\text{ °C}$, $9\text{ V} \leq V_{IN} \leq 25\text{ V}$, $I_o = 200\text{ mA}$		1.2	15	
Load Regulation	REG _L	$T_j = 25\text{ °C}$, $5\text{ mA} \leq I_o \leq 500\text{ mA}$		4.8	25	mV
		$T_j = 25\text{ °C}$, $5\text{ mA} \leq I_o \leq 200\text{ mA}$		2.4	15	
Quiescent Current	I _{BIAS}	$T_j = 25\text{ °C}$		4	6.0	mA
Quiescent Current Change	ΔI_{BIAS}	$9\text{ V} \leq V_{IN} \leq 25\text{ V}$, $I_o = 200\text{ mA}$			0.8	mA
		$5\text{ mA} \leq I_o \leq 350\text{ mA}$			0.5	
Output Noise Voltage	V_n	$T_j = 25\text{ °C}$, $10\text{ Hz} \leq f \leq 100\text{ kHz}$		45		μV _{r.m.s.}
Ripple Rejection	R•R	$T_j = 25\text{ °C}$, $f = 120\text{ Hz}$, $9\text{ V} \leq V_{IN} \leq 19\text{ V}$, $I_o = 300\text{ mA}$	67	83		dB
Dropout Voltage	V _{DIF}	$T_j = 25\text{ °C}$		2.0		V
Short Circuit Current	I _o short	$T_j = 25\text{ °C}$, $V_{IN} = 35\text{ V}$		430		mA
Peak Output Current	I _o peak	$T_j = 25\text{ °C}$		1.0		A
Temperature Coefficient of Output Voltage	$\Delta V_o/\Delta T$	$I_o = 5\text{ mA}$		-1.0		mV/°C

ELECTRICAL CHARACTERISTICS μPC78M07A

($V_{IN} = 12\text{ V}$, $I_o = 350\text{ mA}$, $0\text{ °C} \leq T_j \leq +125\text{ °C}$)

CHARACTERISTIC	SYMBOL	TEST CONDITIONS	MIN.	TYP.	MAX.	UNIT
Output Voltage	V_o	$T_j = 25\text{ °C}$	6.72	7.0	7.28	V
		$9.5\text{ V} \leq V_{IN} \leq 22\text{ V}$, $5\text{ mA} \leq I_o \leq 350\text{ mA}$	6.65		7.35	
		$-30\text{ °C} \leq T_j \leq +125\text{ °C}$	6.65		7.35	
Line Regulation	REG _{IN}	$T_j = 25\text{ °C}$, $9.5\text{ V} \leq V_{IN} \leq 25\text{ V}$, $I_o = 200\text{ mA}$		5	25	mV
		$T_j = 25\text{ °C}$, $10\text{ V} \leq V_{IN} \leq 25\text{ V}$, $I_o = 200\text{ mA}$		1.5	20	
Load Regulation	REG _L	$T_j = 25\text{ °C}$, $5\text{ mA} \leq I_o \leq 500\text{ mA}$		5.6	30	mV
		$T_j = 25\text{ °C}$, $5\text{ mA} \leq I_o \leq 200\text{ mA}$		2.8	15	
Quiescent Current	I _{BIAS}	$T_j = 25\text{ °C}$		4	6.0	mA
Quiescent Current Change	ΔI_{BIAS}	$9.5\text{ V} \leq V_{IN} \leq 25\text{ V}$, $I_o = 200\text{ mA}$			0.8	mA
		$5\text{ mA} \leq I_o \leq 350\text{ mA}$			0.5	
Output Noise Voltage	V_n	$T_j = 25\text{ °C}$, $10\text{ Hz} \leq f \leq 100\text{ kHz}$		50		μV _{r.m.s.}
Ripple Rejection	R•R	$T_j = 25\text{ °C}$, $f = 120\text{ Hz}$, $10\text{ V} \leq V_{IN} \leq 20\text{ V}$, $I_o = 300\text{ mA}$	66	82		dB
Dropout Voltage	V _{DIF}	$T_j = 25\text{ °C}$		2.0		V
Short Circuit Current	I _{Oshort}	$T_j = 25\text{ °C}$, $V_{IN} = 35\text{ V}$		430		mA
Peak Output Current	I _{Opeak}	$T_j = 25\text{ °C}$		1.0		A
Temperature Coefficient of Output Voltage	$\Delta V_o/\Delta T$	$I_o = 5\text{ mA}$		-1.1		mV/°C

ELECTRICAL CHARACTERISTICS μPC78M08A

($V_{IN} = 14\text{ V}$, $I_o = 350\text{ mA}$, $0\text{ °C} \leq T_j \leq +125\text{ °C}$)

CHARACTERISTIC	SYMBOL	TEST CONDITIONS	MIN.	TYP.	MAX.	UNIT
Output Voltage	V_o	$T_j = 25\text{ °C}$	7.7	8.0	8.3	V
		$10.5\text{ V} \leq V_{IN} \leq 23\text{ V}$, $5\text{ mA} \leq I_o \leq 350\text{ mA}$	7.6		8.4	
		$-30\text{ °C} \leq T_j \leq +125\text{ °C}$	7.6		8.4	
Line Regulation	REG _{IN}	$T_j = 25\text{ °C}$, $10.5\text{ V} \leq V_{IN} \leq 25\text{ V}$, $I_o = 200\text{ mA}$		6	30	mV
		$T_j = 25\text{ °C}$, $11\text{ V} \leq V_{IN} \leq 25\text{ V}$, $I_o = 200\text{ mA}$		2	25	
Load Regulation	REG _L	$T_j = 25\text{ °C}$, $5\text{ mA} \leq I_o \leq 500\text{ mA}$		6.4	35	mV
		$T_j = 25\text{ °C}$, $5\text{ mA} \leq I_o \leq 200\text{ mA}$		3.2	20	
Quiescent Current	I _{BIAS}	$T_j = 25\text{ °C}$		4.2	6.0	mA
Quiescent Current Change	ΔI_{BIAS}	$10.5\text{ V} \leq V_{IN} \leq 25\text{ V}$, $I_o = 200\text{ mA}$			0.8	mA
		$5\text{ mA} \leq I_o \leq 350\text{ mA}$			0.5	
Output Noise Voltage	V_n	$T_j = 25\text{ °C}$, $10\text{ Hz} \leq f \leq 100\text{ kHz}$		55		μV _{r.m.s.}
Ripple Rejection	R•R	$T_j = 25\text{ °C}$, $f = 120\text{ Hz}$, $11.5\text{ V} \leq V_{IN} \leq 21.5\text{ V}$, $I_o = 300\text{ mA}$	66	81		dB
Dropout Voltage	V _{DIF}	$T_j = 25\text{ °C}$		2.0		V
Short Circuit Current	I _{Oshort}	$T_j = 25\text{ °C}$, $V_{IN} = 35\text{ V}$		430		mA
Peak Output Current	I _{Opeak}	$T_j = 25\text{ °C}$		1.0		A
Temperature Coefficient of Output Voltage	$\Delta V_o/\Delta T$	$I_o = 5\text{ mA}$		-1.3		mV/°C

ELECTRICAL CHARACTERISTICS μPC78M09A
 (V_{IN} = 15 V, I_o = 350 mA, 0 °C ≤ T_j ≤ + 125 °C)

CHARACTERISTIC	SYMBOL	TEST CONDITIONS	MIN.	TYP.	MAX.	UNIT
Output Voltage	V _o	T _j = 25 °C	8.64	9.0	9.36	V
		11.5 V ≤ V _{IN} ≤ 24 V, 5 mA ≤ I _o ≤ 350 mA	8.55		9.45	
		- 30 °C ≤ T _j ≤ + 125 °C	8.55		9.45	
Line Regulation	REG _{IN}	T _j = 25 °C, 11.5 V ≤ V _{IN} ≤ 25 V, I _o = 200 mA		6.5	35	mV
		T _j = 25 °C, 12 V ≤ V _{IN} ≤ 25 V, I _o = 200 mA		2	30	
Load Regulation	REG _L	T _j = 25 °C, 5 mA ≤ I _o ≤ 500 mA		7.2	40	mV
		T _j = 25 °C, 5 mA ≤ I _o ≤ 200 mA		3.6	20	
Quiescent Current	I _{BIAS}	T _j = 25 °C		4.2	6.0	mA
Quiescent Current Change	ΔI _{BIAS}	11.5 V ≤ V _{IN} ≤ 25 V, I _o = 200 mA			0.8	mA
		5 mA ≤ I _o ≤ 350 mA			0.5	
Output Noize Voltage	V _n	T _j = 25 °C, 10 Hz ≤ f ≤ 100 kHz		60		μV _{r.m.s.}
Ripple Rejection	R•R	T _j = 25 °C, f = 120 Hz, 12 V ≤ V _{IN} ≤ 22 V, I _o = 300 mA	65	80		dB
Dropout Voltage	V _{DIF}	T _j = 25 °C		2.0		V
Short Circuit Current	I _{Oshort}	T _j = 25 °C, V _{IN} = 35 V		430		mA
Peak Output Current	I _{Opeak}	T _j = 25 °C		1.0		A
Temperature Coefficient of Output Voltage	ΔV _o /ΔT	I _o = 5 mA		- 1.4		mV/°C

ELECTRICAL CHARACTERISTICS μPC78M10A
 (V_{IN} = 17 V, I_o = 350 mA, 0 °C ≤ T_j ≤ + 125 °C)

CHARACTERISTIC	SYMBOL	TEST CONDITIONS	MIN.	TYP.	MAX.	UNIT
Output Voltage	V _o	T _j = 25 °C	9.6	10.0	10.4	V
		12.5 V ≤ V _{IN} ≤ 25 V, 5 mA ≤ I _o ≤ 350 mA	9.5		10.5	
		- 30 °C ≤ T _j ≤ + 125 °C	9.5		10.5	
Line Regulation	REG _{IN}	T _j = 25 °C, 12.5 V ≤ V _{IN} ≤ 28 V, I _o = 200 mA		7	35	mV
		T _j = 25 °C, 14 V ≤ V _{IN} ≤ 28 V, I _o = 200 mA		2	30	
Load Regulation	REG _L	T _j = 25 °C, 5 mA ≤ I _o ≤ 500 mA		8	40	mV
		T _j = 25 °C, 5 mA ≤ I _o ≤ 200 mA		4	20	
Quiescent Current	I _{BIAS}	T _j = 25 °C		4.3	6.0	mA
Quiescent Current Change	ΔI _{BIAS}	12.5 V ≤ V _{IN} ≤ 28 V			0.8	mA
		5 mA ≤ I _o ≤ 350 mA			0.5	
Output Noize Voltage	V _n	T _j = 25 °C, 10 Hz ≤ f ≤ 100 kHz		65		μV _{r.m.s.}
Ripple Rejection	R•R	T _j = 25 °C, f = 120 Hz, 13 V ≤ V _{IN} ≤ 23 V, I _o = 300 mA	64	79		dB
Dropout Voltage	V _{DIF}	T _j = 25 °C		2.0		V
Short Circuit Current	I _{Oshort}	T _j = 25 °C, V _{IN} = 35 V		430		mA
Peak Output Current	I _{Opeak}	T _j = 25 °C		1.0		A
Temperature Coefficient of Output Voltage	ΔV _o /ΔT	I _o = 5 mA		- 1.6		mV/°C

ELECTRICAL CHARACTERISTICS μ PC78M12A**($V_{IN} = 19\text{ V}$, $I_o = 350\text{ mA}$, $0\text{ }^\circ\text{C} \leq T_j \leq +125\text{ }^\circ\text{C}$)**

CHARACTERISTIC	SYMBOL	TEST CONDITIONS	MIN.	TYP.	MAX.	UNIT
Output Voltage	V_o	$T_j = 25\text{ }^\circ\text{C}$	11.5	12.0	12.5	V
		$14.5\text{ V} \leq V_{IN} \leq 27\text{ V}$, $5\text{ mA} \leq I_o \leq 350\text{ mA}$	11.4		12.6	
		$-30\text{ }^\circ\text{C} \leq T_j \leq +125\text{ }^\circ\text{C}$	11.4		12.6	
Line Regulation	REG_{IN}	$T_j = 25\text{ }^\circ\text{C}$, $14.5\text{ V} \leq V_{IN} \leq 30\text{ V}$, $I_o = 200\text{ mA}$		8	40	mV
		$T_j = 25\text{ }^\circ\text{C}$, $16\text{ V} \leq V_{IN} \leq 30\text{ V}$, $I_o = 200\text{ mA}$		2	30	
Load Regulation	REG_L	$T_j = 25\text{ }^\circ\text{C}$, $5\text{ mA} \leq I_o \leq 500\text{ mA}$		9.6	50	mV
		$T_j = 25\text{ }^\circ\text{C}$, $5\text{ mA} \leq I_o \leq 200\text{ mA}$		4.8	25	
Quiescent Current	I_{BIAS}	$T_j = 25\text{ }^\circ\text{C}$		4.3	6.0	mA
Quiescent Current Change	ΔI_{BIAS}	$14.5\text{ V} \leq V_{IN} \leq 30\text{ V}$, $I_o = 200\text{ mA}$			0.8	mA
		$5\text{ mA} \leq I_o \leq 350\text{ mA}$			0.5	
Output Noise Voltage	V_n	$T_j = 25\text{ }^\circ\text{C}$, $10\text{ Hz} \leq f \leq 100\text{ kHz}$		70		$\mu\text{V}_{r.m.s.}$
Ripple Rejection	$R \cdot R$	$T_j = 25\text{ }^\circ\text{C}$, $f = 120\text{ Hz}$, $15\text{ V} \leq V_{IN} \leq 25\text{ V}$, $I_o = 300\text{ mA}$	62	78		dB
Dropout Voltage	V_{DIF}	$T_j = 25\text{ }^\circ\text{C}$		2.0		V
Short Circuit Current	I_{Oshort}	$T_j = 25\text{ }^\circ\text{C}$, $V_{IN} = 35\text{ V}$		430		mA
Peak Output Current	I_{Opeak}	$T_j = 25\text{ }^\circ\text{C}$		1.0		A
Temperature Coefficient of Output Voltage	$\Delta V_o/\Delta T$	$I_o = 5\text{ mA}$		-1.9		mV/ $^\circ\text{C}$

ELECTRICAL CHARACTERISTICS μ PC78M15A**($V_{IN} = 23\text{ V}$, $I_o = 350\text{ mA}$, $0\text{ }^\circ\text{C} \leq T_j \leq +125\text{ }^\circ\text{C}$)**

CHARACTERISTIC	SYMBOL	TEST CONDITIONS	MIN.	TYP.	MAX.	UNIT
Output Voltage	V_o	$T_j = 25\text{ }^\circ\text{C}$	14.4		15.6	V
		$17.5\text{ V} \leq V_{IN} \leq 30\text{ V}$, $5\text{ mA} \leq I_o \leq 350\text{ mA}$	14.25		15.75	
		$-30\text{ }^\circ\text{C} \leq T_j \leq +125\text{ }^\circ\text{C}$	14.25		15.75	
Line Regulation	REG_{IN}	$T_j = 25\text{ }^\circ\text{C}$, $17.5\text{ V} \leq V_{IN} \leq 30\text{ V}$, $I_o = 200\text{ mA}$		10	50	mV
		$T_j = 25\text{ }^\circ\text{C}$, $20\text{ V} \leq V_{IN} \leq 30\text{ V}$, $I_o = 200\text{ mA}$		3	40	
Load Regulation	REG_L	$T_j = 25\text{ }^\circ\text{C}$, $5\text{ mA} \leq I_o \leq 500\text{ mA}$		12	60	mV
		$T_j = 25\text{ }^\circ\text{C}$, $5\text{ mA} \leq I_o \leq 200\text{ mA}$		6	30	
Quiescent Current	I_{BIAS}	$T_j = 25\text{ }^\circ\text{C}$		4.4	6.0	mA
Quiescent Current Change	ΔI_{BIAS}	$17.5\text{ V} \leq V_{IN} \leq 30\text{ V}$, $I_o = 300\text{ mA}$			0.8	mA
		$5\text{ mA} \leq I_o \leq 350\text{ mA}$			0.5	
Output Noise Voltage	V_n	$T_j = 25\text{ }^\circ\text{C}$, $10\text{ Hz} \leq f \leq 100\text{ kHz}$		85		$\mu\text{V}_{r.m.s.}$
Ripple Rejection	$R \cdot R$	$T_j = 25\text{ }^\circ\text{C}$, $f = 120\text{ Hz}$, $18.5\text{ V} \leq V_{IN} \leq 28.5\text{ V}$, $I_o = 300\text{ mA}$	60	75		dB
Dropout Voltage	V_{DIF}	$T_j = 25\text{ }^\circ\text{C}$		2.0		V
Short Circuit Current	I_{Oshort}	$T_j = 25\text{ }^\circ\text{C}$, $V_{IN} = 35\text{ V}$		430		mA
Peak Output Current	I_{Opeak}	$T_j = 25\text{ }^\circ\text{C}$		1.0		A
Temperature Coefficient of Output Voltage	$\Delta V_o/\Delta T$	$I_o = 5\text{ mA}$		-2.4		mV/ $^\circ\text{C}$

ELECTRICAL CHARACTERISTICS μPC78M18A

($V_{IN} = 27\text{ V}$, $I_o = 350\text{ mA}$, $0\text{ °C} \leq T_j \leq +125\text{ °C}$)

CHARACTERISTIC	SYMBOL	TEST CONDITIONS	MIN.	TYP.	MAX.	UNIT
Output Voltage	Vo	$T_j = 25\text{ °C}$	17.3	18.0	18.7	V
		$21\text{ V} \leq V_{IN} \leq 33\text{ V}$, $5\text{ mA} \leq I_o \leq 350\text{ mA}$	17.1		18.9	
		$-30\text{ °C} \leq T_j \leq +125\text{ °C}$	17.1		18.9	
Line Regulation	REG _{IN}	$T_j = 25\text{ °C}$, $21\text{ V} \leq V_{IN} \leq 33\text{ V}$, $I_o = 200\text{ mA}$		10	50	mV
		$T_j = 25\text{ °C}$, $24\text{ V} \leq V_{IN} \leq 30\text{ V}$, $I_o = 200\text{ mA}$		4	40	
Load Regulation	REG _L	$T_j = 25\text{ °C}$, $5\text{ mA} \leq I_o \leq 500\text{ mA}$		14.4	75	mV
		$T_j = 25\text{ °C}$, $5\text{ mA} \leq I_o \leq 200\text{ mA}$		7.2	40	
Quiescent Current	I _{BIAS}	$T_j = 25\text{ °C}$		4.6	6.0	mA
Quiescent Current Change	ΔI _{BIAS}	$21\text{ V} \leq V_{IN} \leq 33\text{ V}$, $I_o = 200\text{ mA}$			0.8	mA
		$5\text{ mA} \leq I_o \leq 350\text{ mA}$			0.5	
Output Noise Voltage	V _n	$T_j = 25\text{ °C}$, $10\text{ Hz} \leq f \leq 100\text{ kHz}$		100		μV _{r.m.s.}
Ripple Rejection	R•R	$T_j = 25\text{ °C}$, $f = 120\text{ Hz}$, $22\text{ V} \leq V_{IN} \leq 32\text{ V}$, $I_o = 300\text{ mA}$	57	73		dB
Dropout Voltage	V _{DIF}	$T_j = 25\text{ °C}$		2.0		V
Short Circuit Current	I _{Oshort}	$T_j = 25\text{ °C}$, $V_{IN} = 35\text{ V}$		430		mA
Peak Output Current	I _{Opeak}	$T_j = 25\text{ °C}$		1.0		A
Temperature Coefficient of Output Voltage	ΔV _o /ΔT	$I_o = 5\text{ mA}$		-2.9		mV/°C

ELECTRICAL CHARACTERISTICS μPC78M24A

($V_{IN} = 33\text{ V}$, $I_o = 350\text{ mA}$, $0\text{ °C} \leq T_j \leq +125\text{ °C}$)

CHARACTERISTIC	SYMBOL	TEST CONDITIONS	MIN.	TYP.	MAX.	UNIT
Output Voltage	Vo	$T_j = 25\text{ °C}$	23.0	24.0	25.0	V
		$27\text{ V} \leq V_{IN} \leq 38\text{ V}$, $5\text{ mA} \leq I_o \leq 350\text{ mA}$	22.8		25.2	
		$-30\text{ °C} \leq T_j \leq +125\text{ °C}$	22.8		25.2	
Line Regulation	REG _{IN}	$T_j = 25\text{ °C}$, $27\text{ V} \leq V_{IN} \leq 38\text{ V}$, $I_o = 200\text{ mA}$		10	50	mV
		$T_j = 25\text{ °C}$, $28\text{ V} \leq V_{IN} \leq 38\text{ V}$, $I_o = 200\text{ mA}$		5	40	
Load Regulation	REG _L	$T_j = 25\text{ °C}$, $5\text{ mA} \leq I_o \leq 500\text{ mA}$		19.2	100	mV
		$T_j = 25\text{ °C}$, $5\text{ mA} \leq I_o \leq 200\text{ mA}$		9.6	50	
Quiescent Current	I _{BIAS}	$T_j = 25\text{ °C}$		4.8	6.0	mA
Quiescent Current Change	ΔI _{BIAS}	$27\text{ V} \leq V_{IN} \leq 38\text{ V}$, $I_o = 200\text{ mA}$			0.8	mA
		$5\text{ mA} \leq I_o \leq 350\text{ mA}$			0.5	
Output Noise Voltage	V _n	$T_j = 25\text{ °C}$, $10\text{ Hz} \leq f \leq 100\text{ kHz}$		120		μV _{r.m.s.}
Ripple Rejection	R•R	$T_j = 25\text{ °C}$, $f = 120\text{ Hz}$, $28\text{ V} \leq V_{IN} \leq 38\text{ V}$, $I_o = 300\text{ mA}$	52	68		dB
Dropout Voltage	V _{DIF}	$T_j = 25\text{ °C}$		2.0		V
Short Circuit Current	I _{Oshort}	$T_j = 25\text{ °C}$, $V_{IN} = 35\text{ V}$		430		mA
Peak Output Current	I _{Opeak}	$T_j = 25\text{ °C}$		1.0		A
Temperature Coefficient of Output Voltage	ΔV _o /ΔT	$I_o = 5\text{ mA}$		-3.8		mV/°C

TYPICAL CHARACTERISTICS (T_a = 25 °C)

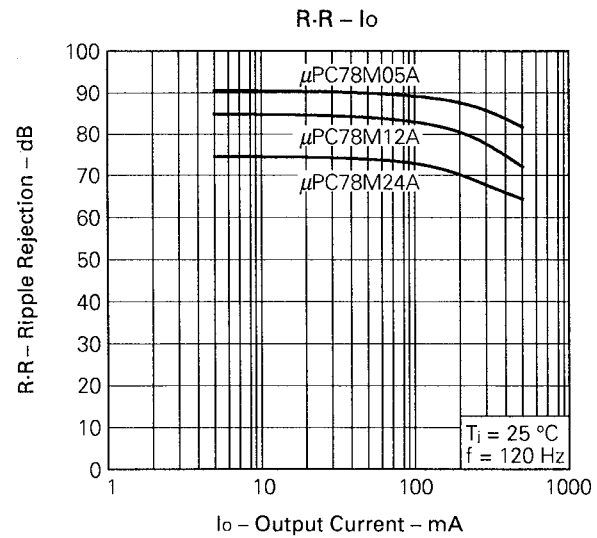
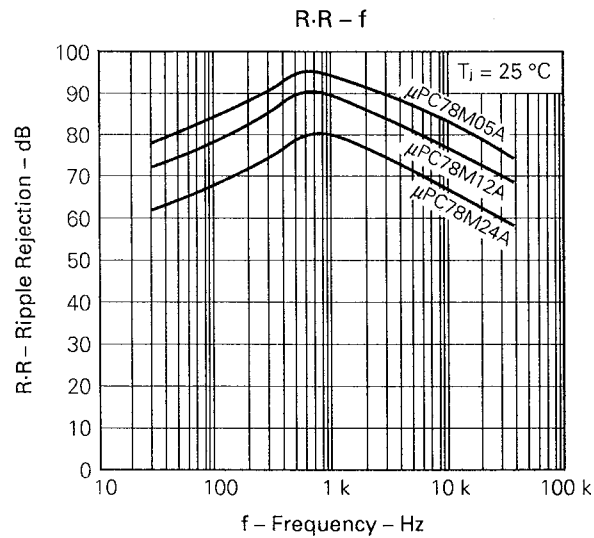
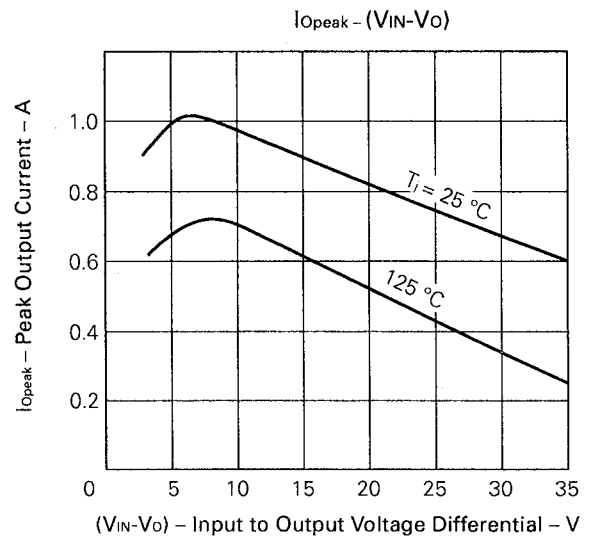
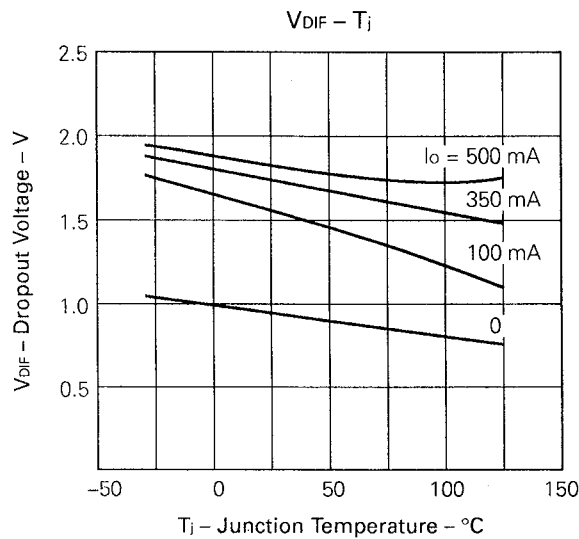
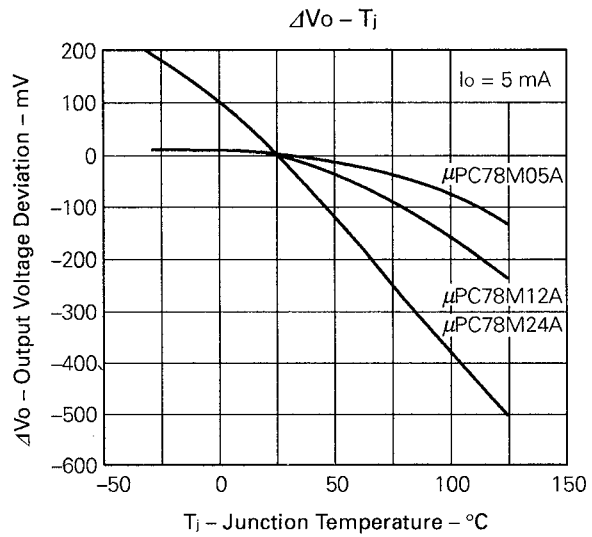
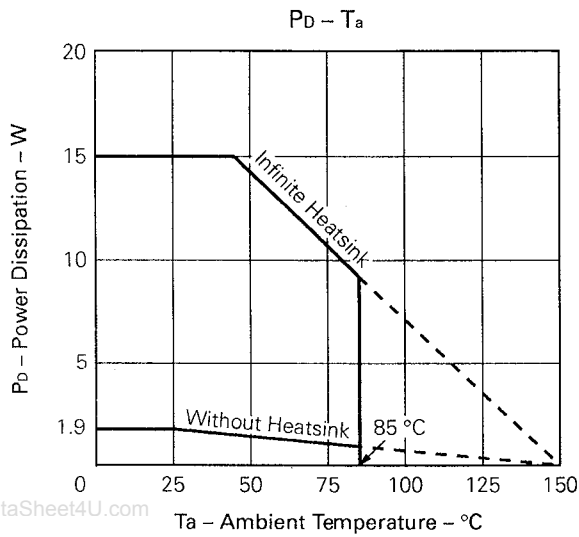

www.DataSheet4U.com

www.DataSheet4U.com

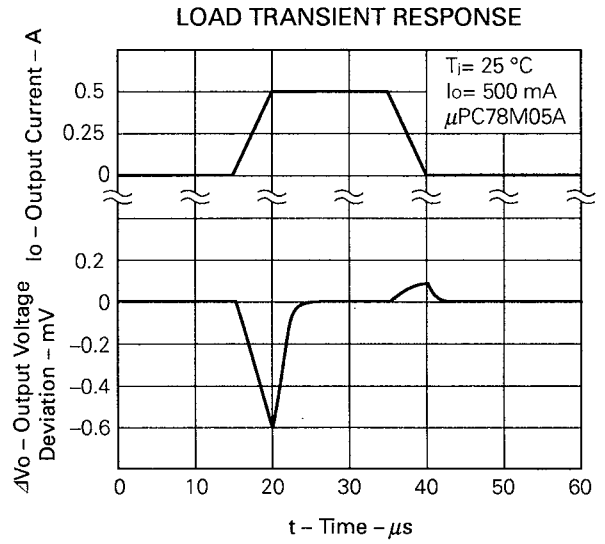
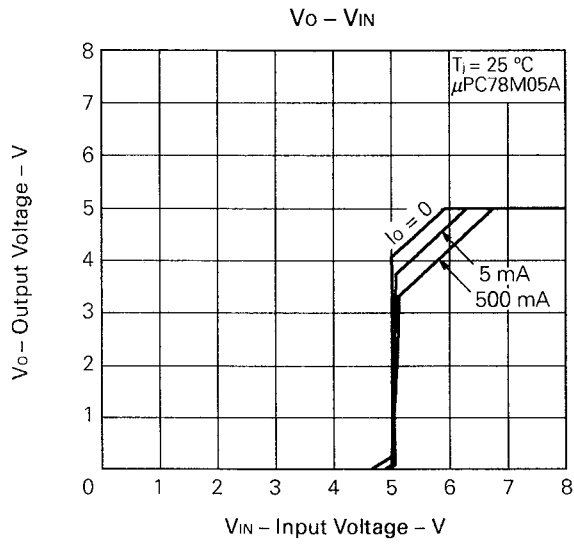

www.DataSheet4U.com

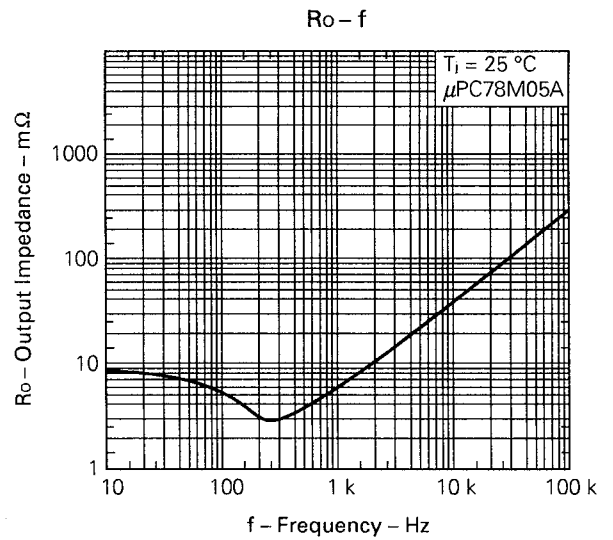
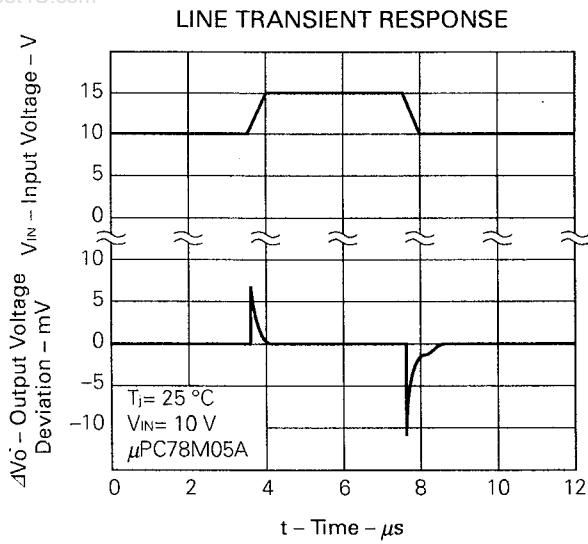

PACKAGE DIMENSIONS

3PIN PLASTIC SIP (MP-45G)

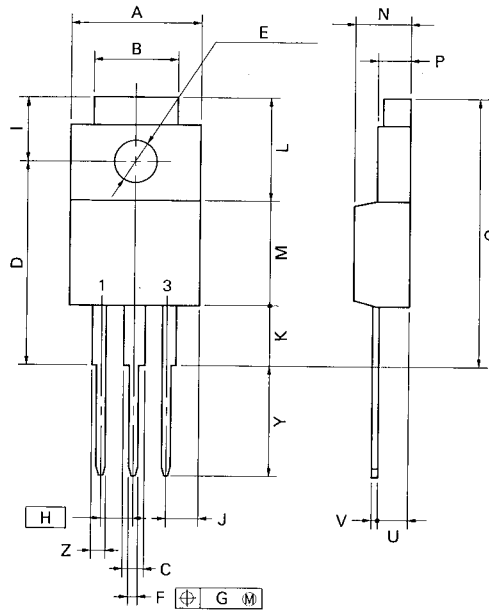

www.DataSheet4U.com

P3HF-254B-1

NOTE

Each lead centerline is located within 0.25 mm (0.01 inch) of its true position (T.P.) at maximum material condition.

ITEM	MILLIMETERS	INCHES
A	10.4 MAX.	0.410 MAX.
B	7.0	0.276
C	1.2 MIN.	0.047 MIN.
D	17.0 ^{±0.3}	0.669 ^{+0.013} _{-0.012}
E	φ3.3 ^{±0.2}	φ0.130 ^{±0.008}
F	0.75 ^{±0.10}	0.030 ^{+0.004} _{-0.005}
G	0.25	0.010
H	2.54 (T.P.)	0.100 (T.P.)
I	5.0 ^{±0.3}	0.197 ^{±0.012}
J	2.66 MAX.	0.105 MAX.
K	4.8 MIN.	0.188 MIN.
L	8.5	0.335
M	8.5	0.335
N	4.5 ^{±0.2}	0.177 ^{±0.008}
P	2.8 ^{±0.2}	0.110 ^{+0.009} _{-0.008}
Q	22.4 MAX.	0.882 MAX.
U	2.4 ^{±0.5}	0.094 ^{+0.021} _{-0.020}
V	0.65 ^{±0.10}	0.026 ^{+0.004} _{-0.005}
Y	8.9 ^{±0.7}	0.350 ^{±0.028}
Z	1.0 MIN.	0.039 MIN.

RECOMMENDED SOLDERING CONDITIONS

The following conditions (see table below) must be met when soldering this product.
 Please consult with our sales offices in case other soldering process is used, or in case soldering is done under different conditions.

TYPES OF THROUGH HOLE MOUNT DEVICE

μPC78M00AHF Series

Soldering process	Soldering conditions	Symbol
Wave soldering	Solder temperature : 260 °C or below. Flow time : 10 seconds or below.	

[MEMO]

www.DataSheet4U.com

No part of this document may be copied or reproduced in any form or by any means without the prior written consent of NEC Corporation. NEC Corporation assumes no responsibility for any errors which may appear in this document.

NEC Corporation does not assume any liability for infringement of patents, copyrights or other intellectual property rights of third parties by or arising from use of a device described herein or any other liability arising from use of such device. No license, either express, implied or otherwise, is granted under any patents, copyrights or other intellectual property rights of NEC Corporation or others.

The devices listed in this document are not suitable for use in aerospace equipment, submarine cables, nuclear reactor control systems and life support systems. If customers intend to use NEC devices for above applications or they intend to use "Standard" quality grade NEC devices for applications not intended by NEC, please contact our sales people in advance.

Application examples recommended by NEC Corporation.

Standard: Computer, Office equipment, Communication equipment, Test and Measurement equipment, Machine tools, Industrial robots, Audio and Visual equipment, Other consumer products, etc.

Special: Automotive and Transportation equipment, Traffic control systems, Antidisaster systems, Anticrime systems, etc.

M4 92.6