

## AXIAL LEAD BI-DIRECTIONAL THYRISTOR SURGE PROTECTOR DEVICE

### FEATURES

- Protects by limiting voltages and shunting surge currents away from sensitive circuits
- Designed for telecommunications applications such as line cards, modems, PBX, FAX, LAN, VHDLS
- Helps meet standards such as GR1089, ITU K.20, IEC950, UL1459&50, FCC part 68
- Low capacitance, High surge (A, B, C rating available), precise voltage limiting, Long life

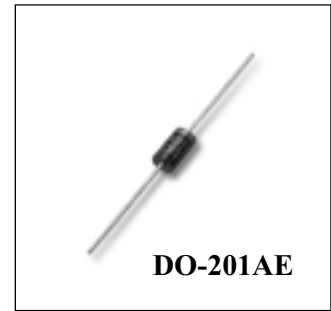

### SUMMARY ELECTRICAL CHARACTERISTICS

Part Number	Rated Repetitive Peak Off-State Voltage	Breakover Voltage	On-State Voltage	Repetitive Peak Off-State Current	Breakover Current	Holding Current	Off-State Capacitance (f = 1 MHz, V <sub>ac</sub> = 15 mV <sub>RMS</sub> )			
	Max.	Max.	Max.	Max.	Max.	Min.	Typ.	Max.	Typ.	Max.
	V <sub>DRM</sub>	V <sub>BO</sub> @ I <sub>BO</sub>	V <sub>T</sub> @ 1A	I <sub>DRM</sub>	I <sub>BO</sub>	I <sub>H</sub>	C <sub>o</sub> @ 0 V <sub>dc</sub>		C <sub>o</sub> @ 50 V <sub>dc</sub>	
	V	V	V	μA	mA	mA	pF		pF	
TSP058C	58	77	5	5	800	150	85	105	35	43
TSP065C	65	88	5	5	800	150	80	101	34	40
TSP075C	75	98	5	5	800	150	78	95	30	37
TSP090C	90	130	5	5	800	150	70	80	23	34
TSP120C	120	160	5	5	800	150	63	79	20	29
TSP140C	140	180	5	5	800	150	61	78	19	28
TSP160C	160	220	5	5	800	150	58	75	19	27
TSP190C	190	260	5	5	800	150	57	71	19	26
TSP220C	220	300	5	5	800	150	57	71	18	26
TSP275C	275	350	5	5	800	150	56	70	18	25
TSP320C	320	400	5	5	800	150	56	70	17	24
Notes	(1,3)	(3,5,6)	(3)	(3)	(3)	(2,3)	(3)	(3)	(3)	(3)

#### NOTES:

1. Specific V<sub>DRM</sub> values are available by request.
2. Specific I<sub>H</sub> values are available by request.
3. All ratings and characteristics are at 25 °C unless otherwise specified.
4. V<sub>DRM</sub> applies for the life of the device. I<sub>DRM</sub> will be in spec during and following operation of the device.
5. V<sub>BO1</sub> is at 100V/msec, I<sub>SC</sub> = 10A<sub>pk</sub>, V<sub>OC</sub> = 1KV<sub>pk</sub>, 10/1000 Waveform
6. V<sub>BO2</sub> is at f = 60 Hz, I<sub>SC</sub> = 1 A<sub>(RMS)</sub>, V<sub>ac</sub> = 1KV<sub>(RMS)</sub>, R<sub>L</sub> = 1 KΩ, 1/2 AC cycle

## SELECTION GUIDE

Follow these steps to select the proper Thyristor surge protector for your application:

1. Define the operating parameters for the circuit:
  - Ambient operating temperature range
  - Maximum telephone line operating current (highest battery and shortest copper loop)
  - Maximum operating voltage: (Maximum DC bias + peak ringing voltage)
  - Maximum surge current
  - System voltage damage threshold
  - Select device with an off-state voltage rating ( $V_{DRM}$ ) above the maximum operating voltage at the minimum operating temperature.
3. Select surge current ratings ( $I_{PPS}$  and  $I_{TSM}$ )  $\geq$  those which the application must withstand.
4. Verify that the minimum holding current of the device at the maximum ambient temperature is above the maximum dc current of the system.
5. Verify that the maximum breakover voltage of the device is below the system damage threshold.
6. Verify that the circuit's ambient operating temperatures are within the device's operating temperature range.
7. Verify that the device's dimensions fit the application's space considerations.
8. Independently evaluate and test the suitability and performance of the device in the application

### MAXIMUM SURGE RATINGS ( $T_J = 25\text{ }^\circ\text{C}$ UNLESS OTHERWISE NOTED)

Rating	Non-Repetitive Peak Pulse Current						Non-Repetitive Peak On-State Surge Current
Symbol	$I_{PPS}$						$I_{TSM}$
Short-Circuit Current Wave	2/10 $\mu\text{s}$	8/20 $\mu\text{s}$	10/160 $\mu\text{s}$	5/310 $\mu\text{s}$	10/560 $\mu\text{s}$	10/1000 $\mu\text{s}$	<b>60A</b>
Open-Circuit Voltage Wave	2/10 $\mu\text{s}$	1.2/50 $\mu\text{s}$	10/160 $\mu\text{s}$	10/700 $\mu\text{s}$	10/560 $\mu\text{s}$	10/1000 $\mu\text{s}$	
Value	<b>500 A</b>	<b>350 A</b>	<b>200 A</b>	<b>150 A</b>	<b>125 A</b>	<b>100 A</b>	
Notes	(1,2,4,5,6)						(1,2,3,4)

Notes:

1. Thermal accumulation between successive surge tests is not allowed.
2. The device under test initially must be in thermal equilibrium with  $T_J = 25\text{ }^\circ\text{C}$ .
3. Test at 1 cycle, 60 Hz.
4. Surge ratings are non-repetitive because instantaneous junction temperatures may exceed the maximum rated  $T_J$ . Nevertheless, devices will survive many surge applications without degradation. Surge capability will not degrade over a device's typical operating life.
5. Adjust the surge generator for optimum current-wave accuracy when both voltage and current wave specifications cannot be exactly met. The current wave is more important than the voltage wave for accurate surge evaluation.
6. The waveform is defined as A/B ms where:
  - A: (Virtual front time) =  $1.25 \times \text{Rise time} = 1.25 \times (T_b - T_a)$
  - B: (Duration time to 50% level of  $I_{PPS}$ ) =  $T_1 - T_0$

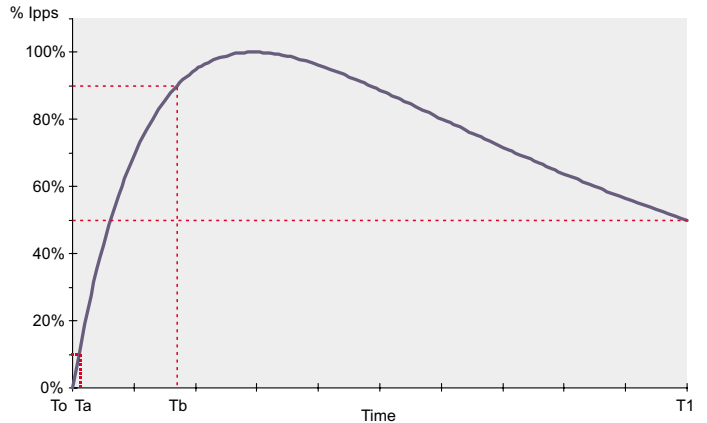

PRELIMINARY

THYRISTOR | TSP058C - TSP320C

PRELIMINARY

## MAXIMUM THERMAL RATINGS

Rating	Symbol	Value	Unit
Storage Junction Temperature Range	T <sub>STG</sub>	-50 to 150	°C
Operating Junction Temperature Range	T <sub>J</sub>	-40 to 150	°C
Operating Ambient Temperature Range	T <sub>a</sub>	-40 to 65	°C

Notes:

PCB board mounted on minimum foot print.

## THERMAL CHARACTERISTICS

Characteristic	Symbol	Value	Unit
Thermal Resistance Junction to Leads T <sub>L</sub> on tab adjacent to plastic. Both leads soldered to identical pad sizes.	R <sub>θJL</sub>	Max. 20	°C / W

Notes:

The junction to lead thermal resistance represents a minimum limiting value with both leads soldered to a large near-infinite heatsink. The junction to ambient thermal resistance depends strongly on board mounting conditions and typically is 3 to 6 times higher than the junction to lead resistance. The data shown is to be used as guideline values for preliminary engineering.

## ELECTRICAL CHARACTERISTICS (T<sub>c</sub> = 25°C UNLESS OTHERWISE NOTED)

Parameters	Test Conditions	Symbol	Min.	Max.	Unit
Repetitive Peak Off-State Current	V <sub>D</sub> = rated V <sub>DRM</sub>	I <sub>DRM</sub>		5	μA
Breakover Current	f = 60 Hz, I <sub>sc</sub> = 1 Arms, V <sub>ac</sub> = 1 KVrms, R <sub>L</sub> = 1 KΩ, 1/2 AC cycle	I <sub>BO</sub>		800	mA
Holding Current <sup>1</sup>	10/1000μs waveform, I <sub>sc</sub> = 10A, V <sub>oc</sub> = 62 V, R <sub>L</sub> = 400 Ω	I <sub>H</sub>	150		mA
On-State Voltage	I <sub>T</sub> = 1 A, T <sub>w</sub> = 300 μs, 1 pulse	V <sub>T</sub>		5	V

Notes:

Specific I<sub>H</sub> values are available by request.

THYRISTOR

TSP058C - TSP320C

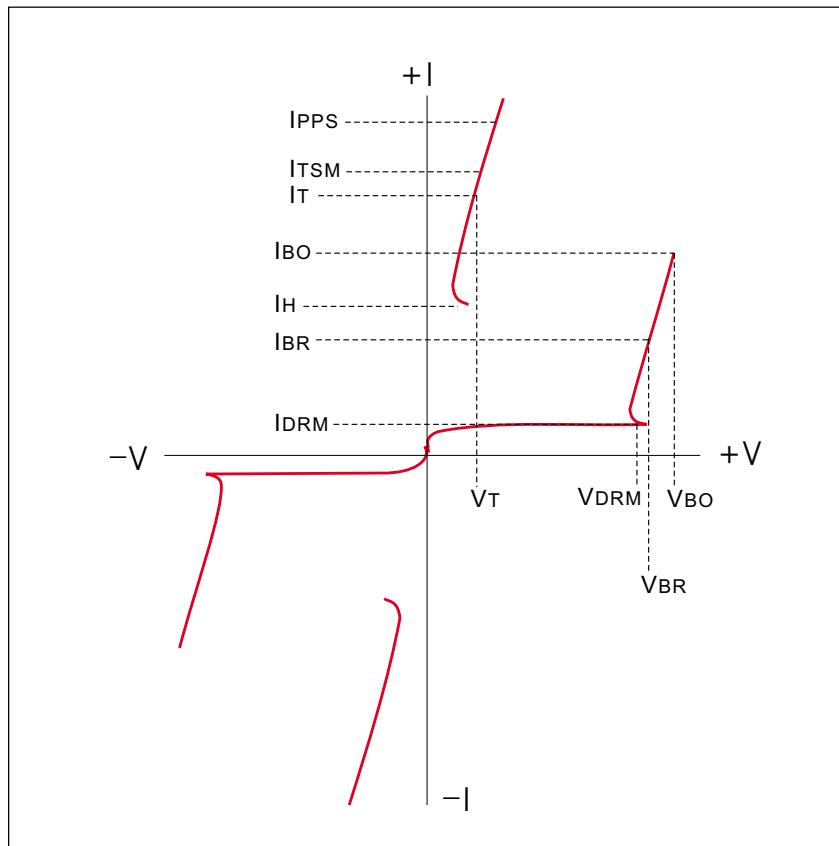

Characteristic	Symbol	Value
V <sub>BO</sub>	Breakover Voltage	Maximum voltage across the device in or at breakdown measured under a specified voltage and current rate of rise
I <sub>BO</sub>	Breakover Current	Instantaneous current flowing at the breakover voltage (V <sub>BO</sub> )
I <sub>H</sub>	Holding Current	Minimum current required to maintain the device in the on-state
I <sub>T</sub>	On-state current	Current through the device in the on-state condition
V <sub>T</sub>	On-state voltage	Voltage across the device in the on-state condition at a specified current (I <sub>T</sub> )
V <sub>DRM</sub>	Rated Repetitive Peak Off-State Voltage	The highest instantaneous value of the off-state voltage, including all repetitive transient voltages but excluding all nonrepetitive transient voltages
I <sub>DRM</sub>	Repetitive Peak Off-State Current	The maximum (peak) value of current that results from the application of V <sub>DRM</sub>
I <sub>PPS</sub>	Non-Repetitive Peak pulse current	Rated maximum value of peak impulse current of specified amplitude and waveshape that may be applied without damage to the device under test
di/dt	Critical rate of rise of on-state current	Rated value of the rate of rise of current that the device can withstand without damage.
dv/dt	Critical Rate of Rise of Off-State Voltage	The maximum rate of rise of voltage (below V <sub>DRM</sub> ) that will not cause switching from the off-state to the on-state.

PRELIMINARY

## CAPACITANCE CHARACTERISTICS

F = 1 MHz,  $V_{ac} = 15 \text{ mV}_{rms}$

Part Number	Off-State Capacitance $C_o$									
	pF									
	0 Vdc		1 Vdc		2 Vdc		5 Vdc		50 Vdc	
	Typ.	Max.	Typ.	Max.	Typ.	Max.	Typ.	Max.	Typ.	Max.
TSP058C	85	105	75	90	69	83	60	70	35	43
TSP065C	80	101	71	86	65	79	56	66	34	40
TSP075C	78	95	65	80	59	73	50	60	30	37
TSP090C	70	80	58	66	52	57	43	50	23	34
TSP120C	63	79	52	60	47	58	39	45	20	29
TSP140C	61	78	50	58	45	56	36	44	19	28
TSP160C	58	75	48	56	43	53	34	43	19	27
TSP190C	57	71	47	55	42	49	33	42	19	26
TSP220C	57	71	47	55	42	49	33	42	18	26
TSP275C	56	70	46	55	42	49	32	42	18	25
TSP320C	56	70	46	55	41	49	32	42	17	24

THYRISTOR

TSP058C - TSP320C

## MECHANICAL DATA

- Case: JEDEC DO-201AE molded plastic
- Terminals: Solder plated, solderable per MIL-STD-750, Method 2026
- Polarity: Bi-directional
- Standard packaging: 52 mm tape
- Weight: 0.04 ounce, 1.1 gram

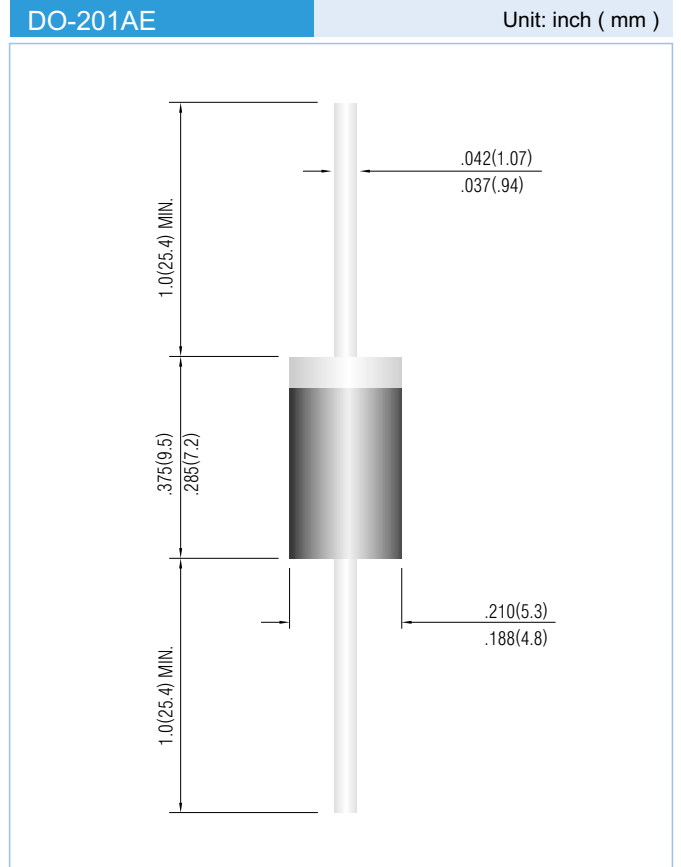

PRELIMINARY

## DEVICE MARKING CODE

Part Number	Marking Code
TSP058C	TSP058C
TSP065C	TSP065C
TSP075C	TSP075C
TSP090C	TSP090C
TSP120C	TSP120C
TSP140C	TSP140C
TSP160C	TSP160C
TSP190C	TSP190C
TSP220C	TSP220C
TSP275C	TSP275C
TSP320C	TSP320C

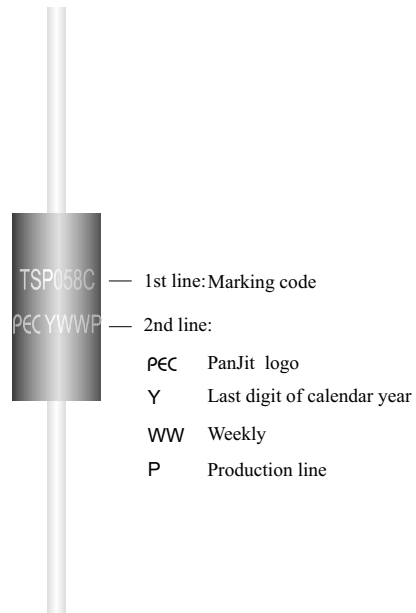

THYRISTOR  
TSP058C - TSP320C

## ORDER & PACKING INFORMATION

Device	Packing	Min. Order Q'ty	Order As	Remark
TSPxxxC	13" Tape & Reel	4,000 pcs	TSPxxxC	Standard Packing
	Bulk	1,000 pcs	TSPxxxC-B	
	Ammunition	3,000 pcs	TSPxxxC-T/B	

## RATING AND CHARACTERISTIC CURVES

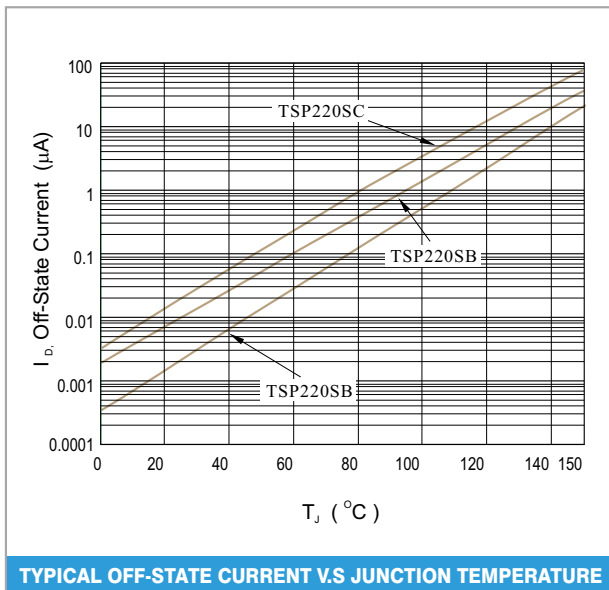
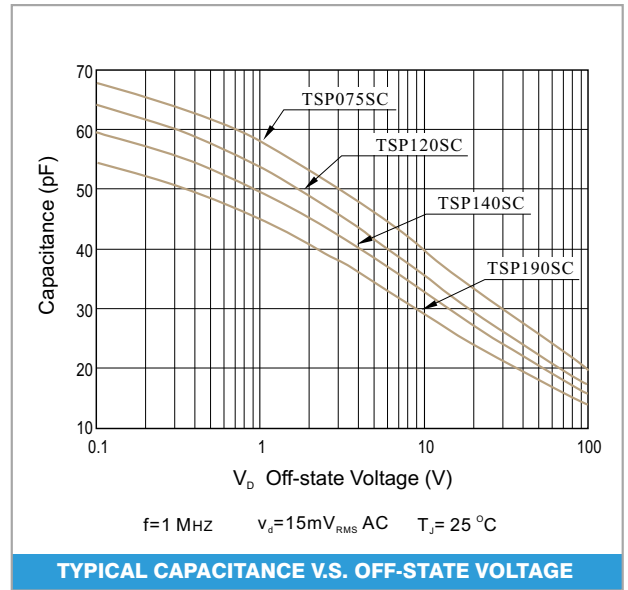
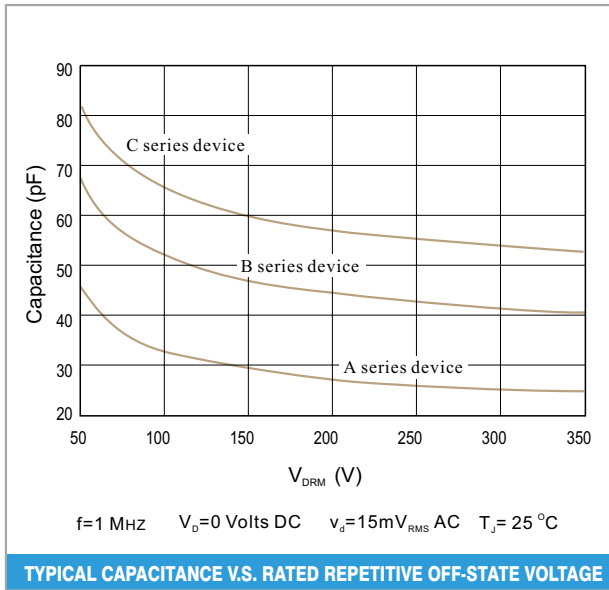

## IMPORTANT NOTICE

This information is intended to unambiguously characterize the product in order to facilitate the customer's evaluation of the device in the application. It will help the customer's technical experts determine that the device is compatible and interchangeable with similar devices made by other vendors. The information in this data sheet is believed to be reliable and accurate. The specifications and information herein are subject to change without notice. New products and improvements in products and their characterization are constantly in process. This provides a superior performing and the highest value product. The factory should be consulted for the most recent information and for any special characteristics not described or specified.

© Copyright Panjit International Inc. 2001

All rights are reserved. Reproduction in whole or in part is prohibited without the prior written consent of the copyright owner.

The information presented in this document does not form part of any quotation or contract, is believed to be accurate and reliable and may be changed without notice. No liability will be accepted by the publisher for any consequence of its use.

Publication thereof does not convey nor imply any license under patent- or other industrial or intellectual property rights.

PanJit International Inc.

<http://www.panjit.com.tw> email: [sales@panjit.com.tw](mailto:sales@panjit.com.tw)

PRELIMINARY

THYRISTOR  
TSP058C - TSP320C