



PESDxS1UB series

ESD protection diodes in SOD 523 package

Rev. 01 — 14 June 2004

Product data sheet

1. Product profile

1.1 General description

Unidirectional ESD protection diode in a SOD523 plastic package designed to protect one transmission or data line from the damage caused by ESD (Electro Static Discharge) and other transients.

1.2 Features

- Unidirectional ESD protection of one line
- Max. peak pulse power: $P_{PP} = 330 \text{ W}$ at $t_p = 8/20 \mu\text{s}$
- Low clamping voltage: $V_{CL} = 20 \text{ V}$ at $I_{PP} = 18 \text{ A}$
- Ultra low leakage current: $I_{RM} < 700 \text{ nA}$
- ESD protection $> 23 \text{ kV}$
- IEC 61000-4-2, level 4 (ESD)
- IEC 61000-4-5 (surge); $I_{PP} = 18 \text{ A}$ at $t_p = 8/20 \mu\text{s}$.

1.3 Applications

- Computers and peripherals
- Communication systems
- Audio and video equipment
- Data lines
- CAN bus protection.

1.4 Quick reference data

Table 1: Quick reference data

Symbol	Parameter	Conditions	Value	Unit
V_{RWM}	reverse standoff voltage			
	PESD3V3S1UB		3.3	V
	PESD5V0S1UB		5	V
	PESD12VS1UB		12	V
	PESD15VS1UB		15	V
	PESD24VS1UB		24	V

PHILIPS

Table 1: Quick reference data ...continued

Symbol	Parameter	Conditions	Value	Unit
C _d	diode capacitance	V _R = 0 V; f = 1 MHz		
	PESD3V3S1UB		207	pF
	PESD5V0S1UB		152	pF
	PESD12VS1UB		38	pF
	PESD15VS1UB		32	pF
	PESD24VS1UB		23	pF
	number of protected lines		1	

2. Pinning information

Table 2: Discrete pinning

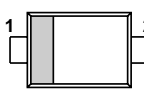
Pin	Description	Simplified outline	Symbol
1	cathode	[1]	 sym035
2	anode	 Top view	

[1] The marking bar indicates the cathode.

3. Ordering information

Table 3: Ordering information

Type number	Package		
	Name	Description	Version
PESDxS1UB	SC -79	plastic surface mounted package; 2 leads	SOD523

4. Marking

Table 4: Marking

Type number	Marking code
PESD3V3S1UB	N1
PESD5V0S1UB	N2
PESD12VS1UB	N3
PESD15VS1UB	N4
PESD24VS1UB	N5

5. Limiting values

Table 5: Limiting values

In accordance with the Absolute Maximum Rating System (IEC 60134).

Symbol	Parameter	Conditions	Min	Max	Unit
P _{PP}	peak pulse power	8/20 μs	[1]		
	PESD3V3S1UB		-	330	W
	PESD5V0S1UB		-	260	W
	PESD12VS1UB		-	180	W
	PESD15VS1UB		-	160	W
	PESD24VS1UB		-	160	W
I _{PP}	peak pulse current	8/20 μs	[1]		
	PESD3V3S1UB		-	18	A
	PESD5V0S1UB		-	15	A
	PESD12VS1UB		-	5	A
	PESD15VS1UB		-	5	A
	PESD24VS1UB		-	3	A
T _j	junction temperature		-	150	°C
T _{amb}	operating ambient temperature		-65	+150	°C
T _{stg}	storage temperature		-65	+150	°C

[1] Non-repetitive current pulse 8/20 μs exponentially decay waveform; see [Figure 1](#).

Table 6: ESD maximum ratings

Symbol	Parameter	Conditions	Min	Max	Unit
ESD	electrostatic discharge capability	IEC 61000-4-2 (contact discharge)	[1]		
	PESD3V3S1UB		-	30	kV
	PESD5V0S1UB		-	30	kV
	PESD12VS1UB		-	30	kV
	PESD15VS1UB		-	30	kV
	PESD24VS1UB		-	23	kV
	PESDxS1UB series	HBM MIL-STD883	-	10	kV

[1] Device stressed with ten non-repetitive Electro Static Discharge (ESD) pulses; see [Figure 2](#).

Table 7: ESD standards compliance

ESD Standard	Conditions
IEC 61000-4-2, level 4 (ESD)	> 15 kV (air); > 8 kV (contact)
HBM MIL-STD883, class 3	> 4 kV

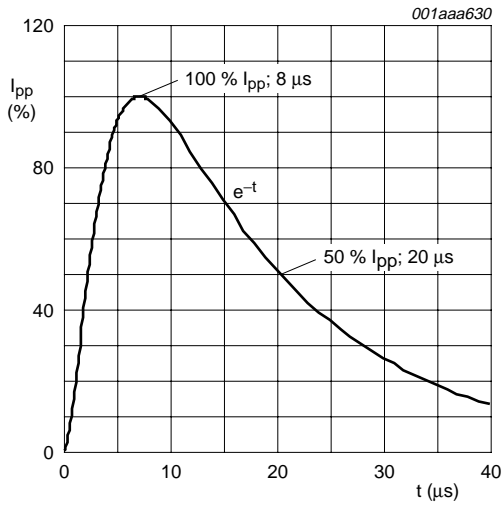

Fig 1. 8/20 μs pulse waveform according to IEC 61000-4-5.

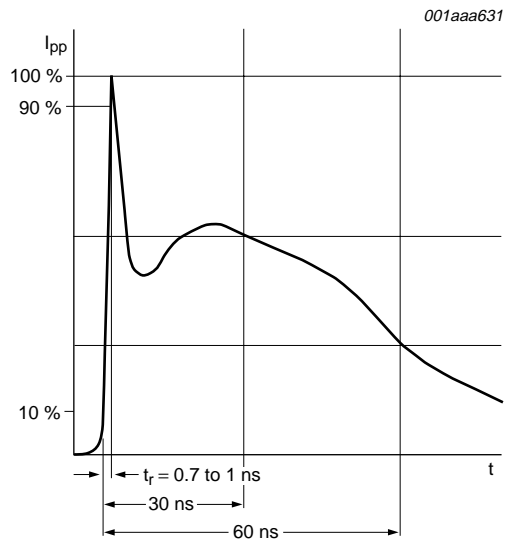

Fig 2. Electro Static Discharge (ESD) pulse waveform according to IEC 61000-4-2.

6. Characteristics

Table 8: Characteristics
 $T_{amb} = 25\text{ }^{\circ}\text{C}$ unless otherwise specified.

Symbol	Parameter	Conditions	Min	Typ	Max	Unit
V_{RWM}	reverse standoff voltage					
	PESD3V3S1UB		-	-	3.3	V
	PESD5V0S1UB		-	-	5	V
	PESD12VS1UB		-	-	12	V
	PESD15VS1UB		-	-	15	V
	PESD24VS1UB		-	-	24	V
I_{RM}	reverse leakage current	see Figure 7				
	PESD3V3S1UB	$V_{RWM} = 3.3\text{ V}$	-	0.7	2	μA
	PESD5V0S1UB	$V_{RWM} = 5\text{ V}$	-	0.1	1	μA
	PESD12VS1UB	$V_{RWM} = 12\text{ V}$	-	< 1	50	nA
	PESD15VS1UB	$V_{RWM} = 15\text{ V}$	-	< 1	50	nA
	PESD24VS1UB	$V_{RWM} = 24\text{ V}$	-	< 1	50	nA
V_{BR}	breakdown voltage	$I_R = 5\text{ mA}$				
	PESD3V3S1UB		5.2	5.6	6.0	V
	PESD5V0S1UB		6.4	6.8	7.2	V
	PESD12VS1UB		14.7	15.0	15.3	V
	PESD15VS1UB		17.6	18.0	18.4	V
	PESD24VS1UB		26.5	27.0	27.5	V
C_d	diode capacitance	$V_R = 0\text{ V}$; $f = 1\text{ MHz}$; see Figure 5 and 6				
	PESD3V3S1UB		-	207	300	pF
	PESD5V0S1UB		-	152	200	pF
	PESD12VS1UB		-	38	75	pF
	PESD15VS1UB		-	32	70	pF
	PESD24VS1UB		-	23	50	pF
$V_{(CLR)}$	clamping voltage		[1]			
	PESD3V3S1UB	$I_{PP} = 1\text{ A}$	-	-	7	V
		$I_{PP} = 18\text{ A}$	-	-	20	V
	PESD5V0S1UB	$I_{PP} = 1\text{ A}$	-	-	9	V
		$I_{PP} = 15\text{ A}$	-	-	20	V
	PESD12VS1UB	$I_{PP} = 1\text{ A}$	-	-	19	V
		$I_{PP} = 5\text{ A}$	-	-	35	V
	PESD15VS1UB	$I_{PP} = 1\text{ A}$	-	-	23	V
		$I_{PP} = 5\text{ A}$	-	-	40	V
	PESD24VS1UB	$I_{PP} = 1\text{ A}$	-	-	36	V
		$I_{PP} = 3\text{ A}$	-	-	70	V

Table 8: Characteristics ...continued
 $T_{amb} = 25\text{ }^{\circ}\text{C}$ unless otherwise specified.

Symbol	Parameter	Conditions	Min	Typ	Max	Unit
R_{diff}	differential resistance					
	PESD3V3S1UB	$I_R = 1\text{ mA}$	-	-	400	Ω
	PESD5V0S1UB	$I_R = 1\text{ mA}$	-	-	80	Ω
	PESD12VS1UB	$I_R = 1\text{ mA}$	-	-	200	Ω
	PESD15VS1UB	$I_R = 1\text{ mA}$	-	-	225	Ω
	PESD24VS1UB	$I_R = 0.5\text{ mA}$	-	-	300	Ω

[1] Non-repetitive current pulse 8/20 μs exponentially decay waveform; see [Figure 1](#).

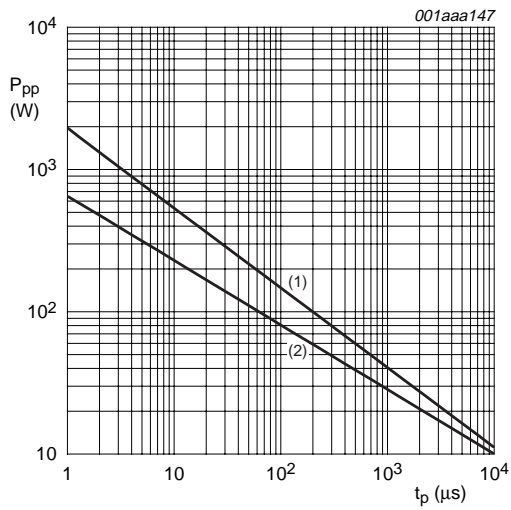

$T_{amb} = 25\text{ }^{\circ}\text{C}$

$t_p = 8/20\text{ }\mu\text{s}$ exponentially decay waveform, see Figure 1.

- (1) PESD3V3S1UB and PESD5V0S1UB.
- (2) PESD12VS1UB, PESD15VS1UB; PESD24VS1UB.

Fig 3. Peak pulse power dissipation as a function of pulse time; typical values.

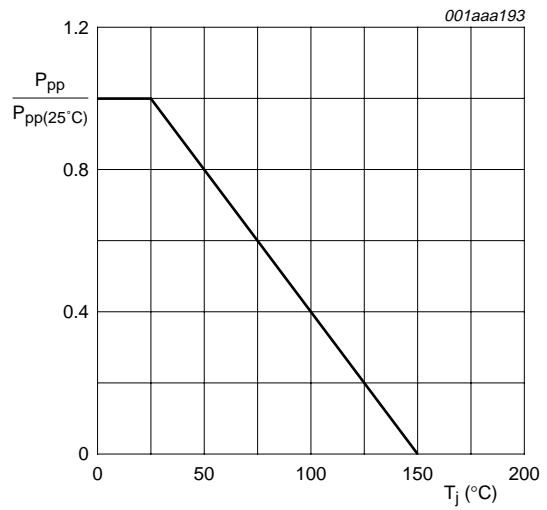
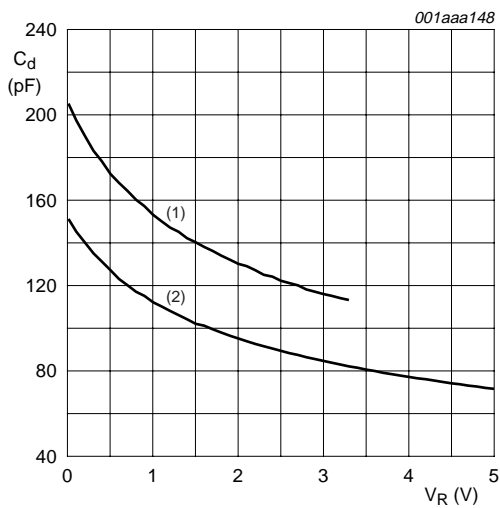

Fig 4. Relative variation of peak pulse power as a function of junction temperature; typical values.



$f = 1\text{ MHz}; T_{amb} = 25\text{ }^{\circ}\text{C}$

- (1) PESD3V3S1UB.
- (2) PESD5V0S1UB.

Fig 5. Diode capacitance as a function of reverse voltage; typical values.

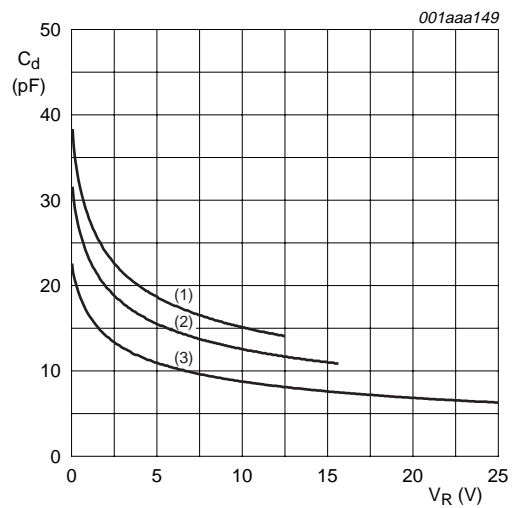

$f = 1\text{ MHz}; T_{amb} = 25\text{ }^{\circ}\text{C}$

- (1) PESD12VS1UB.
- (2) PESD15VS1UB.
- (3) PESD24VS1UB.

Fig 6. Diode capacitance as a function of reverse voltage; typical values.

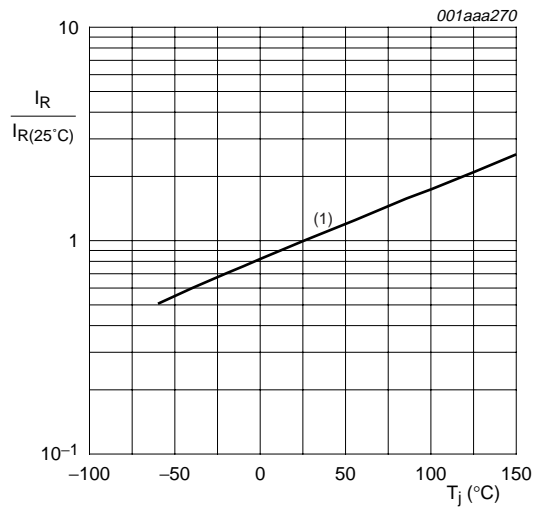

- (1) PESD3V3S1UB; $V_{RWM} = 3.3$ V.
 PESD5V0S1UB; $V_{RWM} = 5$ V.
 I_R is less than 10 nA at 150 °C for:
 PESD12VS1UB; $V_{RWM} = 12$ V.
 PESD15VS1UB; $V_{RWM} = 15$ V.
 PESD24VS1UB; $V_{RWM} = 24$ V.

Fig 7. Relative variation of reverse leakage current as a function of junction temperature; typical values.

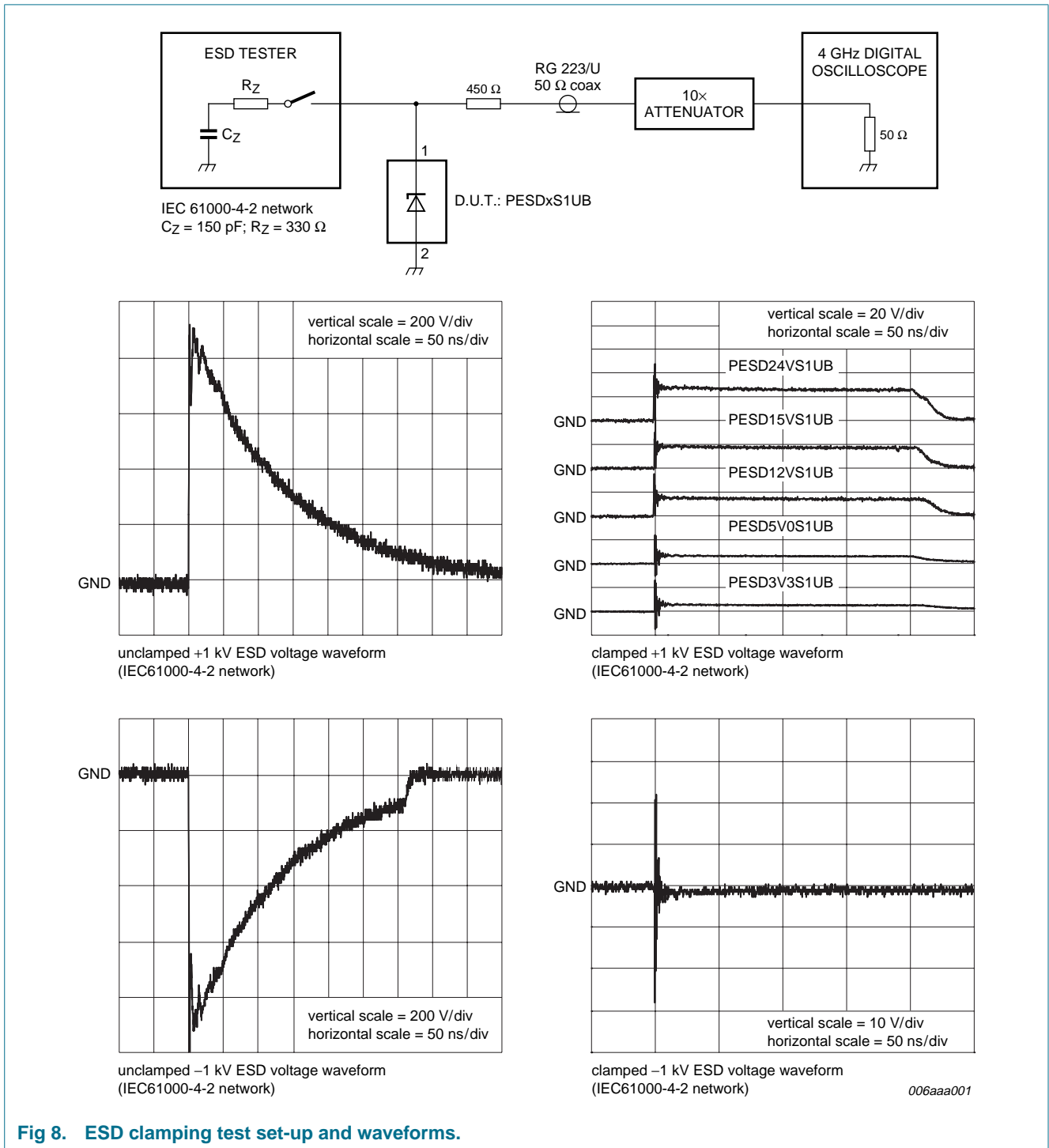

Fig 8. ESD clamping test set-up and waveforms.

7. Application information

The PESDxS1UB series is designed for unidirectional protection of one single data line from the damage caused by ESD (Electro Static Discharge) and Surge Pulses. The PESDxS1UB series may be used on lines where the signal polarity is above or below ground. The PESDxS1UB series provides a surge capability of up to 330 Watts per line for a 8/20 μ s waveform.

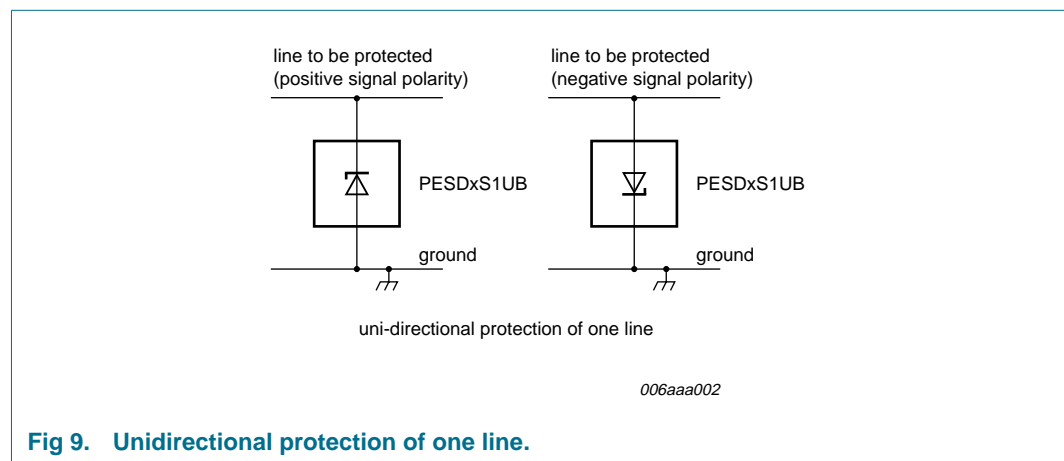

Fig 9. Unidirectional protection of one line.

Circuit board layout and protection device placement:

Circuit board layout is critical for the suppression of ESD, EFT and Surge transients. The following guidelines are recommended:

1. Place the protection device as close to the input terminal or connector as possible.
2. The path length between the protection device and the protected line should be minimized.
3. Keep parallel signal paths to a minimum.
4. Avoid running protection conductors in parallel with unprotected conductor.
5. Minimize all printed-circuit board conductive loops including power and ground loops.
6. Minimize the length of the transient return path to ground.
7. Avoid using shared transient return paths to a common ground point.
8. Ground planes should be used whenever possible. For multilayer printed-circuit boards, use ground vias.

8. Package outline

Plastic surface mounted package; 2 leads

SOD523

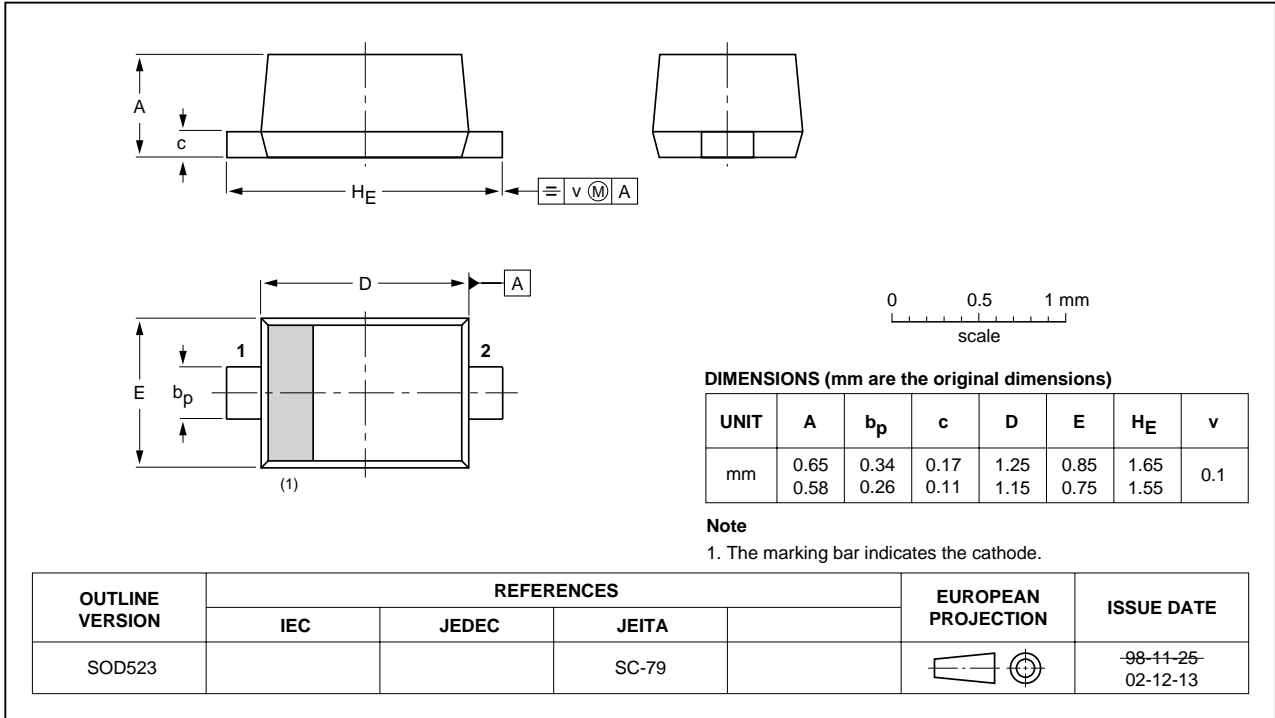

Fig 10. Package outline.

9. Packing information

Table 9: Possible packing methods

The indicated -xxx are the last three digits of the 12 NC ordering code. [\[1\]](#)

Type number	Package	Description	Packing quantity	
			3000	10000
PESD3V3S1UB	SOD523	4 mm pitch, 8 mm tape and reel	-115	-135
PESD5V0S1UB	SOD523	4 mm pitch, 8 mm tape and reel	-115	-135
PESD12VS1UB	SOD523	4 mm pitch, 8 mm tape and reel	-115	-135
PESD15VS1UB	SOD523	4 mm pitch, 8 mm tape and reel	-115	-135
PESD24VS1UB	SOD523	4 mm pitch, 8 mm tape and reel	-115	-135

[1] For further information see [Section 14](#).



10. Revision history

Table 10: Revision history

Document ID	Release date	Data sheet status	Change notice	Order number	Supersedes
PESDxS1UB_series_1	20040614	Product data	-	9397 750 13313	-

11. Data sheet status

Level	Data sheet status ^[1]	Product status ^[2] ^[3]	Definition
I	Objective data	Development	This data sheet contains data from the objective specification for product development. Philips Semiconductors reserves the right to change the specification in any manner without notice.
II	Preliminary data	Qualification	This data sheet contains data from the preliminary specification. Supplementary data will be published at a later date. Philips Semiconductors reserves the right to change the specification without notice, in order to improve the design and supply the best possible product.
III	Product data	Production	This data sheet contains data from the product specification. Philips Semiconductors reserves the right to make changes at any time in order to improve the design, manufacturing and supply. Relevant changes will be communicated via a Customer Product/Process Change Notification (CPCN).

[1] Please consult the most recently issued data sheet before initiating or completing a design.

[2] The product status of the device(s) described in this data sheet may have changed since this data sheet was published. The latest information is available on the Internet at URL <http://www.semiconductors.philips.com>.

[3] For data sheets describing multiple type numbers, the highest-level product status determines the data sheet status.

12. Definitions

Short-form specification — The data in a short-form specification is extracted from a full data sheet with the same type number and title. For detailed information see the relevant data sheet or data handbook.

Limiting values definition — Limiting values given are in accordance with the Absolute Maximum Rating System (IEC 60134). Stress above one or more of the limiting values may cause permanent damage to the device. These are stress ratings only and operation of the device at these or at any other conditions above those given in the Characteristics sections of the specification is not implied. Exposure to limiting values for extended periods may affect device reliability.

Application information — Applications that are described herein for any of these products are for illustrative purposes only. Philips Semiconductors make no representation or warranty that such applications will be suitable for the specified use without further testing or modification.

13. Disclaimers

Life support — These products are not designed for use in life support appliances, devices, or systems where malfunction of these products can reasonably be expected to result in personal injury. Philips Semiconductors customers using or selling these products for use in such applications do so at their own risk and agree to fully indemnify Philips Semiconductors for any damages resulting from such application.

Right to make changes — Philips Semiconductors reserves the right to make changes in the products - including circuits, standard cells, and/or software - described or contained herein in order to improve design and/or performance. When the product is in full production (status 'Production'), relevant changes will be communicated via a Customer Product/Process Change Notification (CPCN). Philips Semiconductors assumes no responsibility or liability for the use of any of these products, conveys no license or title under any patent, copyright, or mask work right to these products, and makes no representations or warranties that these products are free from patent, copyright, or mask work right infringement, unless otherwise specified.

14. Contact information

For additional information, please visit: <http://www.semiconductors.philips.com>

For sales office addresses, send an email to: sales.addresses@www.semiconductors.philips.com

15. Contents

1	Product profile	1
1.1	General description	1
1.2	Features	1
1.3	Applications	1
1.4	Quick reference data	1
2	Pinning information	2
3	Ordering information	2
4	Marking	2
5	Limiting values	3
6	Characteristics	5
7	Application information	10
8	Package outline	11
9	Packing information	12
10	Revision history	13
11	Data sheet status	14
12	Definitions	14
13	Disclaimers	14
14	Contact information	14



© Koninklijke Philips Electronics N.V. 2004

All rights are reserved. Reproduction in whole or in part is prohibited without the prior written consent of the copyright owner. The information presented in this document does not form part of any quotation or contract, is believed to be accurate and reliable and may be changed without notice. No liability will be accepted by the publisher for any consequence of its use. Publication thereof does not convey nor imply any license under patent- or other industrial or intellectual property rights.

Date of release: 14 June 2004
Document order number: 9397 750 13313

Published in The Netherlands