



Cascadable Silicon Bipolar MMIC Amplifiers

Technical Data

MSA-0835, -0836

Features

- **Usable Gain to 6.0 GHz**
- **High Gain:**
32.5 dB Typical at 0.1 GHz
23.0 dB Typical at 1.0 GHz
- **Low Noise Figure:**
3.0 dB Typical at 1.0 GHz
- **Cost Effective Ceramic Microstrip Package**

Description

The MSA-0835 is a high performance silicon bipolar Monolithic Microwave Integrated Circuit (MMIC) housed in a cost effective, microstrip package. This MMIC is designed for use as a general purpose 50 Ω gain block above

0.5 GHz and can be used as a high gain transistor below this frequency. Typical applications include narrow and moderate band IF and RF amplifiers in commercial and industrial applications.

The MSA-series is fabricated using Agilent's 10 GHz f_T , 25 GHz f_{MAX} , silicon bipolar MMIC process which uses nitride self-alignment, ion implantation, and gold metallization to achieve excellent performance, uniformity and reliability. The use of an external bias resistor for temperature and current stability also allows bias flexibility.

Available in cut lead version (package 36) as MSA-0836.

35 micro-X Package^[1]

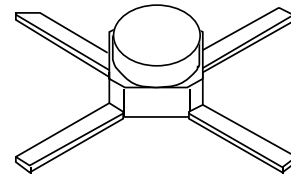

Note:

1. Short leaded 36 package available upon request.

Typical Biasing Configuration

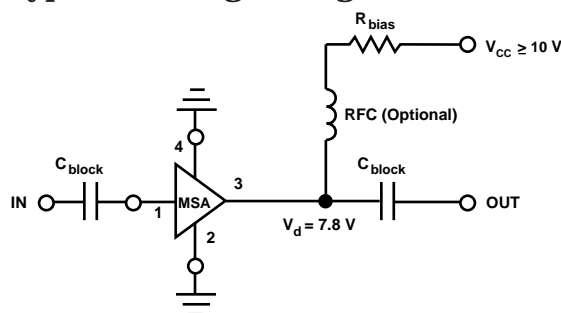

MSA-0835, -0836 Absolute Maximum Ratings

Parameter	Absolute Maximum ^[1]
Device Current	80 mA
Power Dissipation ^[2,3]	750 mW
RF Input Power	+13 dBm
Junction Temperature	200°C
Storage Temperature ^[4]	-65°C to 200°C

Thermal Resistance^{[2,5]:}

$$\theta_{jc} = 175^{\circ}\text{C/W}$$

Notes:

1. Permanent damage may occur if any of these limits are exceeded.
2. $T_{\text{CASE}} = 25^{\circ}\text{C}$.
3. Derate at 5.7 mW/°C for $T_{\text{C}} > 69^{\circ}\text{C}$.
4. Storage above +150°C may tarnish the leads of this package making it difficult to solder into a circuit.
5. The small spot size of this technique results in a higher, though more accurate determination of θ_{jc} than do alternate methods. See MEASUREMENTS section "Thermal Resistance" for more information.

Electrical Specifications^[1], $T_{\text{A}} = 25^{\circ}\text{C}$

Symbol	Parameters and Test Conditions: $I_{\text{d}} = 36 \text{ mA}$, $Z_{\text{o}} = 50 \Omega$	Units	Min.	Typ.	Max.
G_{P}	Power Gain ($ S_{21} ^2$) f = 0.1 GHz f = 1.0 GHz f = 4.0 GHz	dB	22.0	32.5 23.0 10.5	25.0
VSWR	Input VSWR f = 1.0 to 3.0 GHz			2.0:1	
	Output VSWR f = 1.0 to 3.0 GHz			1.5:1	
NF	50 Ω Noise Figure f = 1.0 GHz	dB		3.0	
$P_{1 \text{ dB}}$	Output Power at 1 dB Gain Compression f = 1.0 GHz	dBm		12.5	
IP_3	Third Order Intercept Point f = 1.0 GHz	dBm		27.0	
t_{D}	Group Delay f = 1.0 GHz	psec		125	
V_{d}	Device Voltage	V	7.0	7.8	8.4
dV/dT	Device Voltage Temperature Coefficient	mV/°C		-17.0	

Note:

1. The recommended operating current range for this device is 20 to 40 mA. Typical performance as a function of current is on the following page.

Part Number Ordering Information

Part Number	No. of Devices	Container
MSA-0835	10	Strip
MSA-0836-BLK	100	Antistatic Bag
MSA-0836-TR1	1000	7" Reel

For more information, see "Tape and Reel Packaging for Semiconductor Devices".

MSA-0835, -0836 Typical Scattering Parameters^[1] ($Z_0 = 50 \Omega$, $T_A = 25^\circ\text{C}$, $I_d = 36 \text{ mA}$)

Freq. GHz	S_{11}		S_{21}			S_{12}			S_{22}		k
	Mag	Ang	dB	Mag	Ang	dB	Mag	Ang	Mag	Ang	
0.1	.63	-17	32.5	42.02	161	-37.7	.013	55	.63	-19	0.72
0.2	.58	-33	31.5	37.52	145	-33.7	.021	47	.56	-37	0.73
0.4	.49	-56	29.1	28.50	119	-29.7	.033	54	.42	-66	0.72
0.6	.40	-70	26.7	21.54	103	-27.9	.040	55	.32	-84	0.78
0.8	.35	-80	24.6	17.01	92	-26.0	.050	53	.24	-98	0.85
1.0	.33	-89	22.9	13.98	82	-24.9	.057	52	.18	-107	0.89
1.5	.30	-111	19.5	9.45	64	-22.1	.079	51	.09	-126	0.95
2.0	.30	-133	16.9	7.03	48	-20.2	.098	44	.07	-141	0.99
2.5	.32	-150	14.9	5.53	39	-19.2	.110	42	.06	-166	1.04
3.0	.34	-170	13.2	4.56	26	-18.3	.122	36	.06	-106	1.06
3.5	.38	175	11.7	3.86	14	-17.5	.133	32	.08	-100	1.08
4.0	.39	162	10.5	3.33	2	-16.7	.146	27	.12	-101	1.08
5.0	.41	132	7.9	2.47	-21	-15.6	.165	19	.21	-113	1.10
6.0	.52	95	5.8	1.94	-45	-14.6	.187	7	.20	-149	1.05

Note:

1. A model for this device is available in the DEVICE MODELS section.

Typical Performance, $T_A = 25^\circ\text{C}$

(unless otherwise noted)

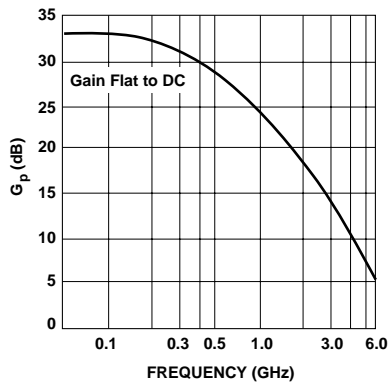

Figure 1. Typical Power Gain vs. Frequency, $I_d = 36 \text{ mA}$.

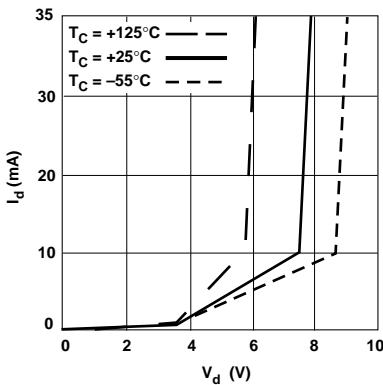

Figure 2. Device Current vs. Voltage.

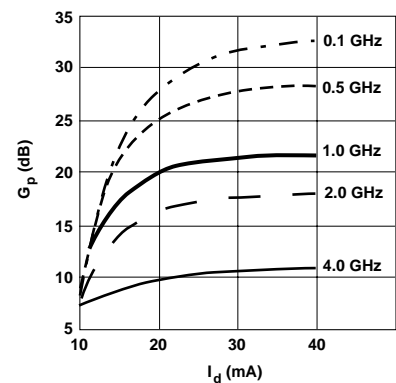

Figure 3. Power Gain vs. Current.

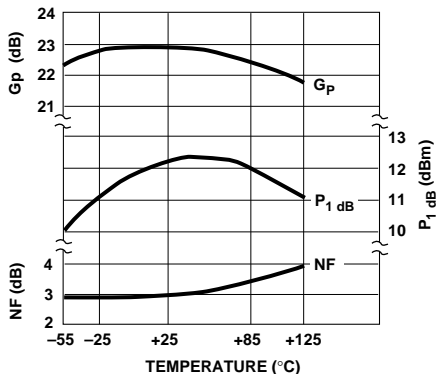

Figure 4. Output Power at 1 dB Gain Compression, NF and Power Gain vs. Case Temperature, $f = 1.0 \text{ GHz}$, $I_d = 36 \text{ mA}$.

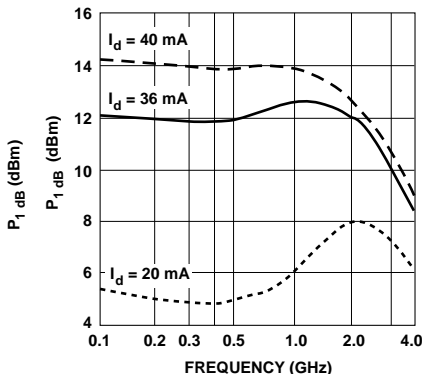

Figure 5. Output Power at 1 dB Gain Compression vs. Frequency.

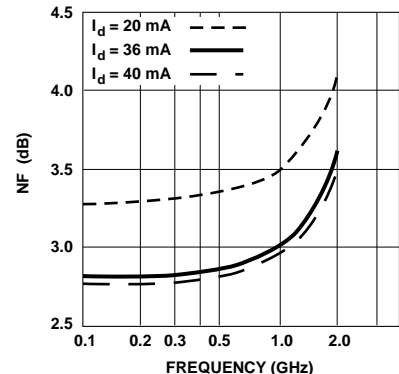

Figure 6. Noise Figure vs. Frequency.



35 micro-X Package Dimensions

