

FEATURES

- Generates Three Adjustable, Low Noise Rails for Small/Medium TFT Displays
- Drives Up to Ten White LEDs
- LED Dimming and Open-Circuit Protection
- Controlled Power-Up/Power-Down Sequencing
- 1.5MHz Fixed Frequency, Low Noise Operation
- V_{IN} Range 2.5V to 6V, V_{OUT} Range 3V to 6V
- TFT Supply Efficiency Up to 90%
- LED Supply Efficiency Up to 78%
- Two Independantly Enabled LED Strings
- 200 to 1 True Color PWM™ Dimming
- Tiny External Solution
- 24-Lead QFN Package (4mm × 4mm × 0.75mm)

APPLICATIONS

- PDAs, Palmtop Computers
- Digital Still and Video Cameras
- Handheld GPS
- Portable Instrument Displays
- Portable Media Players

DESCRIPTION

The LTC®3524 is an integrated BIAS and white LED power converter solution for small/medium-sized polysilicon thin film transistor (TFT) liquid crystal (LCD) display panels. The device operates from a single Lithium-Ion/polymer battery or any voltage source between 2.5V and 6V.

A 1.5MHz synchronous boost converter generates a programmable low noise, high efficiency 25mA TFT supply of up to 6.0V. Regulated, low ripple charge pumps are used to generate up to +20V and -20V at 2mA. Output sequencing is internally controlled to insure proper initialization and rapid discharge of the LCD panel in shutdown.

A second 1.5MHz boost converter powers one or two LED strings with up to five series elements each. LED current and display brightness can be controlled over a wide range using analog or digital means up to 25mA.

The LTC3524 is offered in the 4mm × 4mm 24-pin QFN package, minimizing the total solution footprint.

LT, LT, LTC and LTM are registered trademarks of Linear Technology Corporation. True Color PWM is a registered trademarks of Linear Technology Corporation. All other trademarks are the property of their respective owners.

TYPICAL APPLICATION

+5V, -7.5V, +12.5V, 8 LED Power Supply

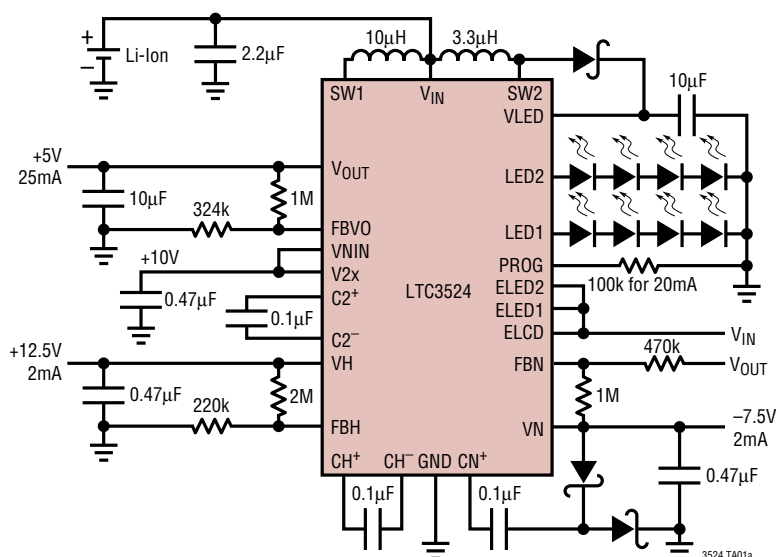

LCD Bias and LED Efficiency
 $V_{IN} = 3.6V$, $V_{OUT} = 5V$, 8 LEDs

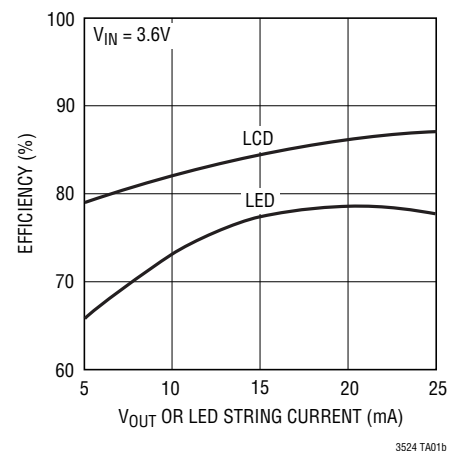

LTC3524

ABSOLUTE MAXIMUM RATINGS

(Referred to GND)

V_{IN} , SW1, V_{OUT} , $C2^-$	-0.3 to 7V
ELCD, ELED1, ELED2, PROG	-0.3 to 7V
FBN, FBH, FBVO	-0.3 to 7V
$V2X$, $C2^+$, CH^-	-0.3 to 13V
LED1, LED2, VLED, SW2	-0.3 to 22V
V_{IN} , VH , CH^+ , CN^+	-0.3 to 21V
V_N	-21 to +0.3V
Operating Temperature Range (Note 2) ...	-40°C to 85°C
Storage Temperature Range	-65°C to 125°C

PIN CONFIGURATION

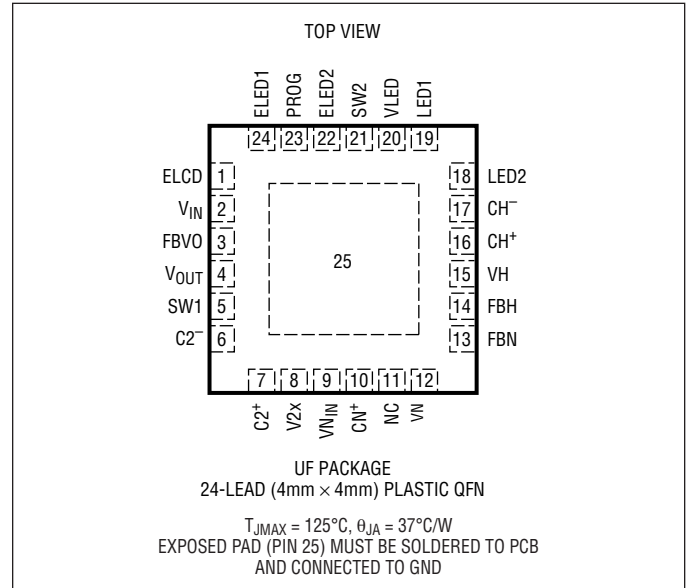

ORDER INFORMATION

LEAD FREE FINISH	TAPE AND REEL	PART MARKING	PACKAGE DESCRIPTION	TEMPERATURE RANGE
LTC3524EUF#PBF	LTC3524EUF#TRPBF	3524	24-Lead (4mm × 4mm) Plastic QFN	-40°C to 85°C
LEAD BASED FINISH	TAPE AND REEL	PART MARKING	PACKAGE DESCRIPTION	TEMPERATURE RANGE
LTC3524EUF	LTC3524EUF#TR	3524	24-Lead (4mm × 4mm) Plastic QFN	-40°C to 85°C

Consult LTC Marketing for parts specified with wider operating temperature ranges.

For more information on lead free part marking, go to: <http://www.linear.com/leadfree/>

For more information on tape and reel specifications, go to: <http://www.linear.com/tapeandree/>

ELECTRICAL CHARACTERISTICS

The ● denotes the specifications which apply over the full operating temperature range, otherwise specifications are $T_A = 25^\circ\text{C}$. $V_{IN} = 3.6\text{V}$, $V_{OUT} = 5.1\text{V}$, $T_A = 25^\circ\text{C}$, unless otherwise noted.

PARAMETER	CONDITIONS	MIN	TYP	MAX	UNITS
Input Voltage Range		● 2.5		6.0	V
V_{IN} Quiescent Supply Current LCD	ELCD = 1.5V, ELED1,2 = GND		200		μA
V_{IN} Quiescent Supply Current LED	ELCD = GND, ELED1,2 = 1.5V (LED1 and LED2 Open)		4		mA
V_{OUT} Quiescent Supply Current LCD	ELCD = 1.5V, ELED1,2 = GND		250		μA
V_{IN} Quiescent Current Shutdown	ELCD = ELED1,2 = GND		.02	2	μA
Switching Frequency	LED and LCD Boosts	1	1.5	2	MHz
Maximum Duty Cycle	LED and LCD Boosts	85	94		%

V_{OUT} Boost Regulator

PARAMETER	CONDITIONS	MIN	TYP	MAX	UNITS
FBVO Regulation Voltage		● 1.20	1.225	1.25	V
V_{OUT} Adjust Range	See Note 3	3.0		6.0	V

3524f

ELECTRICAL CHARACTERISTICS

The ● denotes the specifications which apply over the full operating temperature range, otherwise specifications are $T_A = 25^\circ\text{C}$. $V_{IN} = 3.6\text{V}$, $V_{OUT} = 5.1\text{V}$, $T_A = 25^\circ\text{C}$, unless otherwise noted.

PARAMETER	CONDITIONS	MIN	TYP	MAX	UNITS	
Switch Current Limit		100	150		mA	
Charge Pumps						
V2x Output Voltage	Load on V2x = 250 μA		10		V	
Output Impedance V2x	Flying Capacitors = 0.1 μF		250		Ω	
V2x Maximum Operating Voltage	(Note 3)		12		V	
VH Output Voltage (Quadrupler)	Load = 250 μA (FBH = 1V)		20		V	
Output Impedance (2X + Quadrupler)	Flying Capacitors = 0.1 μF		1200		Ω	
FBH Regulation Voltage		● 1.15	1.225	1.30	V	
VH Maximum Operating Voltage	(Note 3)		20			
VN Output Voltage	Load on VN = 250 μA , $V_{NIN} = 10.2\text{V}$, External Schottkys		-9.7		V	
FBN Regulation Voltage		● 0.94	1	1.06	V	
Output Impedance VN (2X + VN)	Flying Capacitor = 0.1 μF		650		Ω	
VN Minimum Operating Voltage	(Note 3)		-20		V	
Switching Frequency Charge Pumps			94		KHz	
V2x to VN Delay	(Note 4)		2		ms	
VN to VH Delay	(Note 4)		2		ms	
LED Boost						
LED1,2 Current Accuracy	$R_{PROG} = 100\text{k}$		18	20	22	mA
SW2 Maximum Current Limit			500	700		mA
SW2 V_{CESAT}	$I_{SW} = 350\text{mA}$		350			mV
Logic Inputs						
ELED1, ELED2, ELCD Thresholds		● 0.4	0.8	1.2		V

Note 1: Stresses beyond those listed under Absolute Maximum Ratings may cause permanent damage to the device. Exposure to any Absolute Maximum Rating condition for extended periods may affect device reliability and lifetime.

Note 2: The LTC3524E is guaranteed to meet specifications from 0°C to 85°C . Specifications over the -40°C to 85°C operating temperature range are assured by design, characterization, and statistical process controls.

Note 3: Specification is guaranteed by design and not 100% tested in production.

Note 4: Measured from point at which VN crosses $-V_{OUT}$ to point at which CH+ starts switching.

TYPICAL PERFORMANCE CHARACTERISTICS $T_A = 25^\circ\text{C}$, unless otherwise noted.

LCD Boost Efficiency vs Load Current

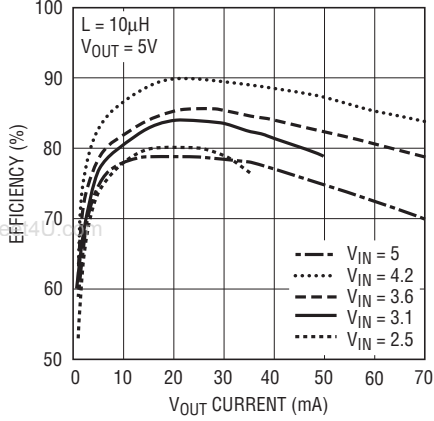

3524 G01

LED Efficiency vs V_{IN}

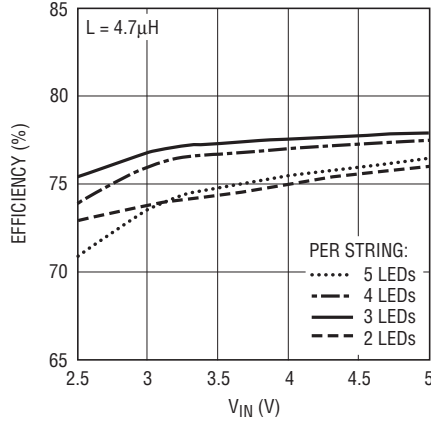

3524 G02

4 LEDs per String Efficiency vs V_{IN} and LED Current

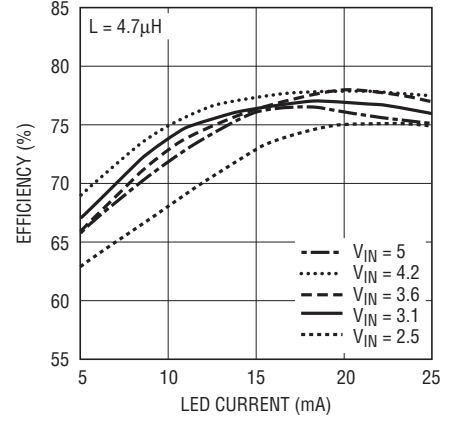

3524 G03

LED1 String Current vs V_{IN} and Number of LEDs

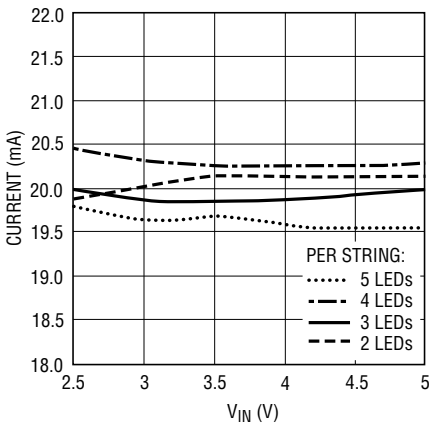

3524 G04

LED2 String Current vs V_{IN} and Number of LEDs

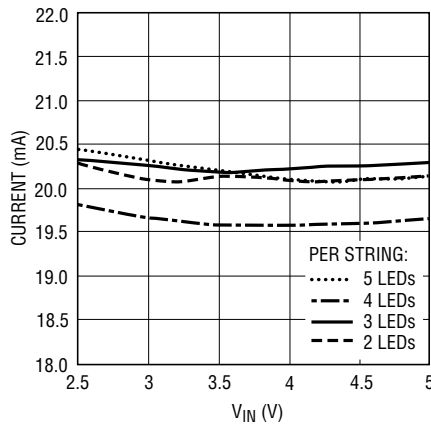

3524 G05

V2X Output Voltage vs V2X Load Current

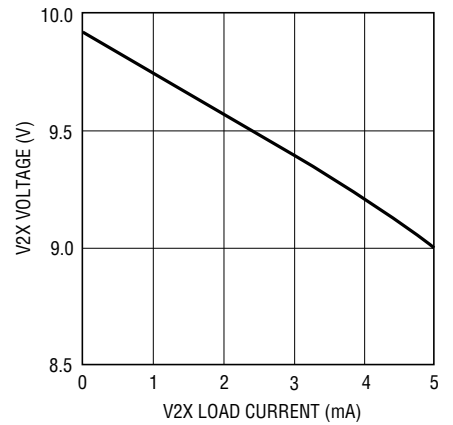

3524 G06

VH Voltage vs VH and VN Load Current (FBH = 0V)

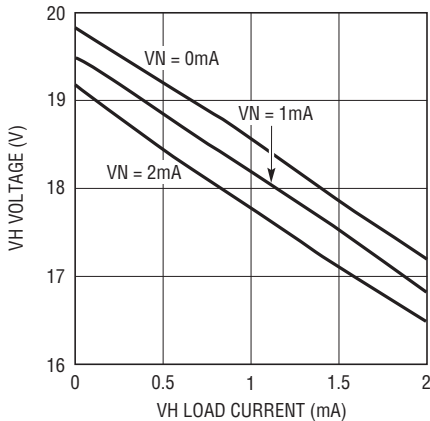

3524 G07

VN Voltage vs VN and VH Load Current (FBN = 1.3V)

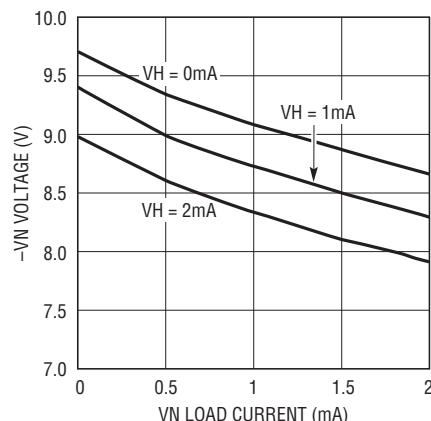

3524 G08

V_{OUT} , $|V_N|$, and $V_H/2$ Regulation Overtemperature

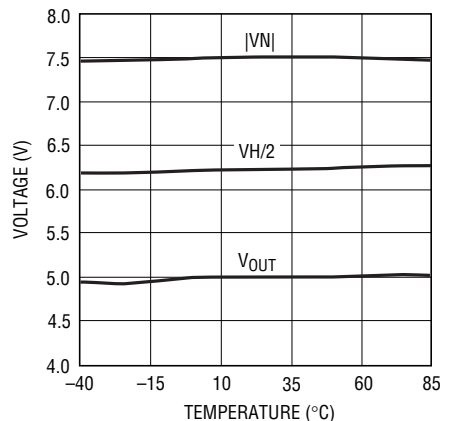

3524 G10

TYPICAL PERFORMANCE CHARACTERISTICS $T_A = 25^\circ\text{C}$, unless otherwise noted.

LCD Bias Sequencing

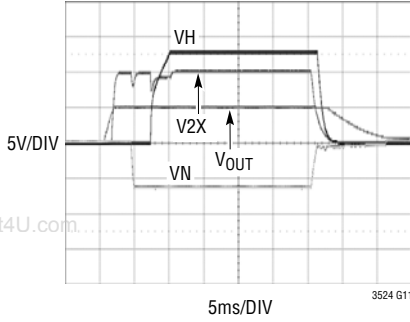

LCD Bias Sequencing

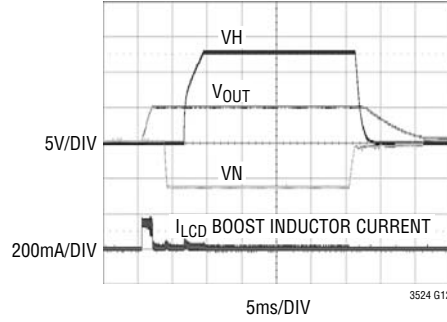

SW1 Voltage and 10µH Inductor Current at 25mA Load

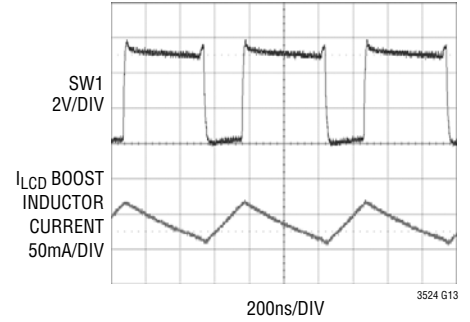

SW1 Voltage and 10µH Inductor Current at 5mA Load

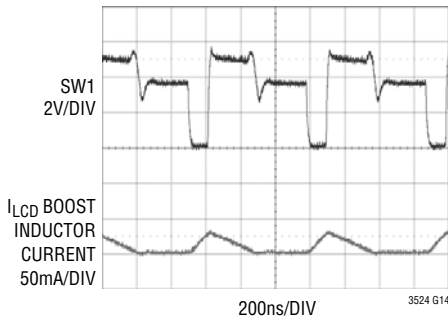

SW2 Voltage and 4.7µH Inductor Current at 20mA

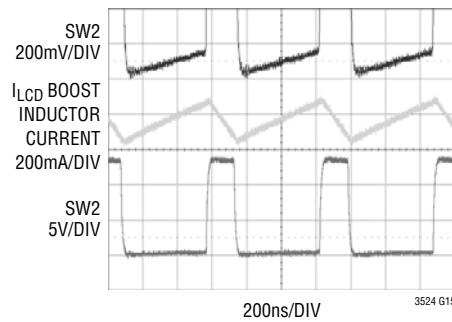

LED Initial Start-Up Waveforms

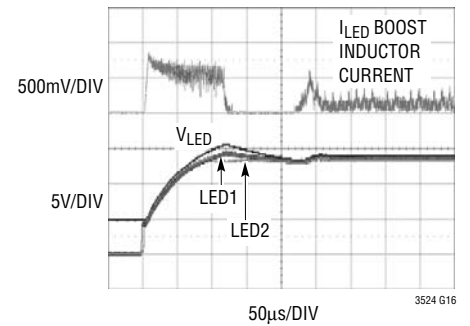

LED Burst Dimming Waveforms LED1 and SW2

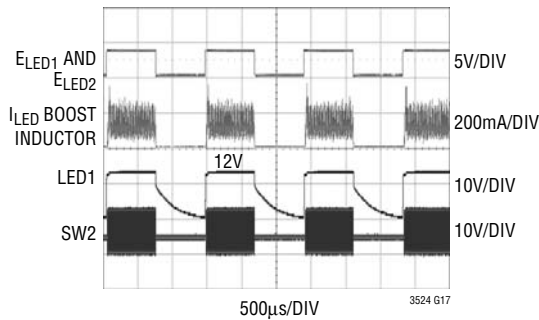

LED Burst Dimming Waveforms LED2 and VLED

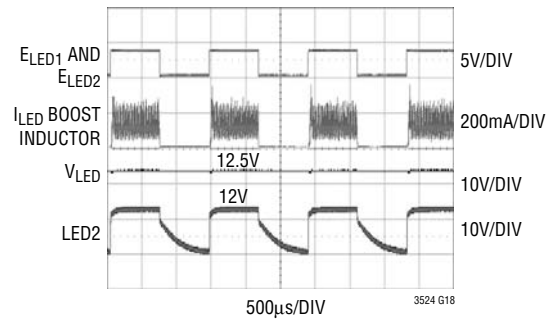

PIN FUNCTIONS

V_{IN} (Pin 2): Common Input Supply for LCD Bias and White LED Boost Converters. This pin must be locally bypassed with a minimum of 2.2μF.

GND/Exposed Pad (Pin 25): Signal and Power Ground for the LTC3524. Provide a short, direct PCB path between GND

and the (–) side of the boost (V_{OUT}, VLED) filter capacitors, and the (–) side of the charge pump outputs (V2x, VH, VN) filter capacitors. PCB ground must be soldered to the Exposed Pad for proper operation.

LCD BIAS PIN FUNCTIONS

ELCD (Pin 1): Enable Input for the LTC3524's LCD Circuits. LCD bias supplies are actively discharged to GND when ELCD is low through internal pull down devices. An optional RC network on ELCD provides a slower ramp-up of the LCD boost converter inductor current during start-up (soft-start). Shutdown mode is activated by driving ELCD, ELED1, and ELED2 low. Shutdown disables all IC functions and reduces quiescent current from the battery to less than 2μA.

FBVO (Pin 3): Feedback Pin for the V_{OUT} Switcher. Reference voltage is 1.225V. Connect resistive divider tap here with minimum trace area.

$$V_{OUT} = 1.225 \left(1 + \frac{R1}{R2} \right) \quad (\text{See Block Diagram})$$

V_{OUT} (Pin 4): Main Output of the LCD Boost Regulator and Input to the Voltage Doubler (2X) Stage. Bypass V_{OUT} with a low ESR, ESL ceramic capacitor (X5R type) between 4.7 and 22μF.

SW1 (Pin 5): Synchronous Boost Switch. Connect a 4.7μH-15μH inductor between SW1 and V_{IN}. Keep PCB trace lengths as short and wide as possible to reduce EMI and voltage overshoot. If the inductor current falls to zero, the PMOS synchronous rectifier is turned off to prevent reverse charging of the inductor and an internal switch connects SW1 to V_{IN} to reduce EMI.

C2[–] (Pin 6): Charge pump doubler flying capacitor negative node. The charge pump doubler flying capacitor is connected between C2⁺ and C2[–]. The voltage on C2[–] will alternate between GND and V_{OUT} at an approximate 50% duty cycle while the charge pump is operating. Use a 0.1μF X5R type ceramic capacitor for best results.

C2⁺ (Pin 7): Charge pump doubler flying capacitor positive node. The charge pump doubler flying capacitor is connected between C2⁺ and C2[–]. The voltage on C2⁺ will alternate between V_{OUT} and V2x at an approximate 50% duty cycle while the charge pump is operating. Use a 0.1μF X5R type ceramic capacitor for best results.

V2x (Pin 8): Charge Pump Doubler Output and Input to the Charge Pump Quadrupler. This output generates 2X V_{OUT}. V2x should be bypassed to GND with a 0.47μF X5R type ceramic capacitor. C2⁺ and C2[–] should be left open and V2x connected to V_{OUT} if the doubler is not needed to generate VH or VN.

VN_{IN} (Pin 9): Positive Voltage Input for the Charge Pump Inverter. The charge pump inverter can generate a regulated negative voltage up to the voltage applied to VN_{IN}. Connect VN_{IN} to V_{OUT}, V2x, or VH. If VN_{IN} is connected to VH, external diodes and a capacitor are required for sequencing (see the Applications Information section).

CN⁺ (Pin 10): Charge Pump Inverter Flying Capacitor Positive Node. The charge pump inverter flying capacitor is connected between CN⁺ and external Schottky diodes (see Typical Application figures). The voltage on CN⁺ will alternate between GND and VN_{IN} at an approximate 50% duty cycle while the inverting charge pump is operating. Use a 0.1μF X5R type ceramic capacitor for best results.

NC (Pin 11): No Connect. This pin should be connected to GND.

VN (Pin 12): Negative Charge Pump Converter Output. VN can be regulated down to approximately –VN_{IN} volts depending on where VN_{IN} is connected. VN should be bypassed to GND with at 0.47μF or larger X5R type ceramic capacitor.

LCD BIAS PIN FUNCTIONS

FBN (Pin 13): Feedback Pin for the VN Charge-Pump Output. Reference voltage is 1.0V. Connect the resistive divider tap between V_{OUT} and VN here with minimum trace area.

$$V_N = \frac{-R_6 (V_{OUT} - 1)}{R_5} + 1 \quad (\text{See Block Diagram})$$

FBH (Pin 14): Feedback Pin for the VH Charge-Pump Output. Reference voltage is 1.225V. Connect resistive divider tap here with minimum trace area.

$$V_H = 1.225 \left(1 + \frac{R_3}{R_4} \right) \quad (\text{See Block Diagram})$$

VH (Pin 15): Charge Pump Quadrupler Output. This output can be regulated to $4X V_{OUT}$ and is capable of delivering

up to 2mA to a load. VH should be bypassed to GND with a 0.47 μ F X5R type ceramic capacitor. Connect V2x to V_{OUT} for applications requiring a regulated voltage less than $2X V_{OUT}$.

CH⁺ (Pin 16): Charge Pump Quadrupler Flying Capacitor Positive Node. The charge pump quadrupler (4X) flying capacitor is connected between CH⁺ and CH⁻. The voltage on CH⁺ will alternate between V2x and VH at an approximate 50% duty cycle while the charge pump is operating. Use a 0.1 μ F X5R type ceramic capacitor for best results.

CH⁻ (Pin 17): Charge Pump Quadrupler (4X) Flying Capacitor Negative Node. The voltage on CH⁻ will alternate between GND and V2x at an approximate 50% duty cycle while the charge pump is operating. Use a 0.1 μ F X5R type ceramic capacitor for best results.

WHITE LED DRIVER PIN FUNCTIONS

LED2 (Pin 18): Output for Second LED String. Connect up to five white LEDs between LED2 (anode) and GND (cathode). For best current matching and efficiency use the same number of white LEDs in both strings.

LED1 (Pin 19): Output for First LED String.

VLED (Pin 20): Output of the LED Switcher. Bypass VLED with a low ESR, ESL ceramic capacitor (X5R type) of at least 1 μ F. Keep PCB trace lengths as short and wide as possible to minimize EMI and voltage overshoot.

SW2 (Pin 21): White LED Boost Switch. Connect a 3.3-15 μ H inductor between SW2 and V_{IN} . This is the collector of the internal NPN power switch. Connect an external Schottky diode between SW2 and VLED. Keep PCB trace lengths as short and wide as possible to minimize EMI and voltage overshoot.

ELED2 (Pin 22): Enable and PWM Dimming Control Input for the LED2 String. The LED2 string is disabled when this pin is grounded. Digital dimming can be implemented by driving the ELED2 pin between 0V and >1.2V at low

frequency (ie., 500Hz). Driving ELCD, ELED1, and ELED2 low initiates shutdown mode which disables all IC functions and reduces quiescent current from the battery to less than 2 μ A.

PROG (Pin 23): A single resistor (RPROG) between PROG and GND sets the current in the LED strings. LED current in mA is programmed by:

$$I_{LED1} = I_{LED2} = \left(\frac{2 \times 10^6}{R_{PROG}} \right) \text{mA}$$

A 100K resistor programs 20mA in each string. Analog dimming can be implemented by connecting a second resistor between PROG and a control voltage.

ELED1 (Pin 24): Enable and Pulse Dimming Control Input for the LED1 String. For applications with five or fewer LEDs, better efficiency is achieved by operating a single LED string. For example, ELED1 = 1, ELED2 = 0, LED2 left open circuit and the LED string connected to LED1.

BLOCK DIAGRAM

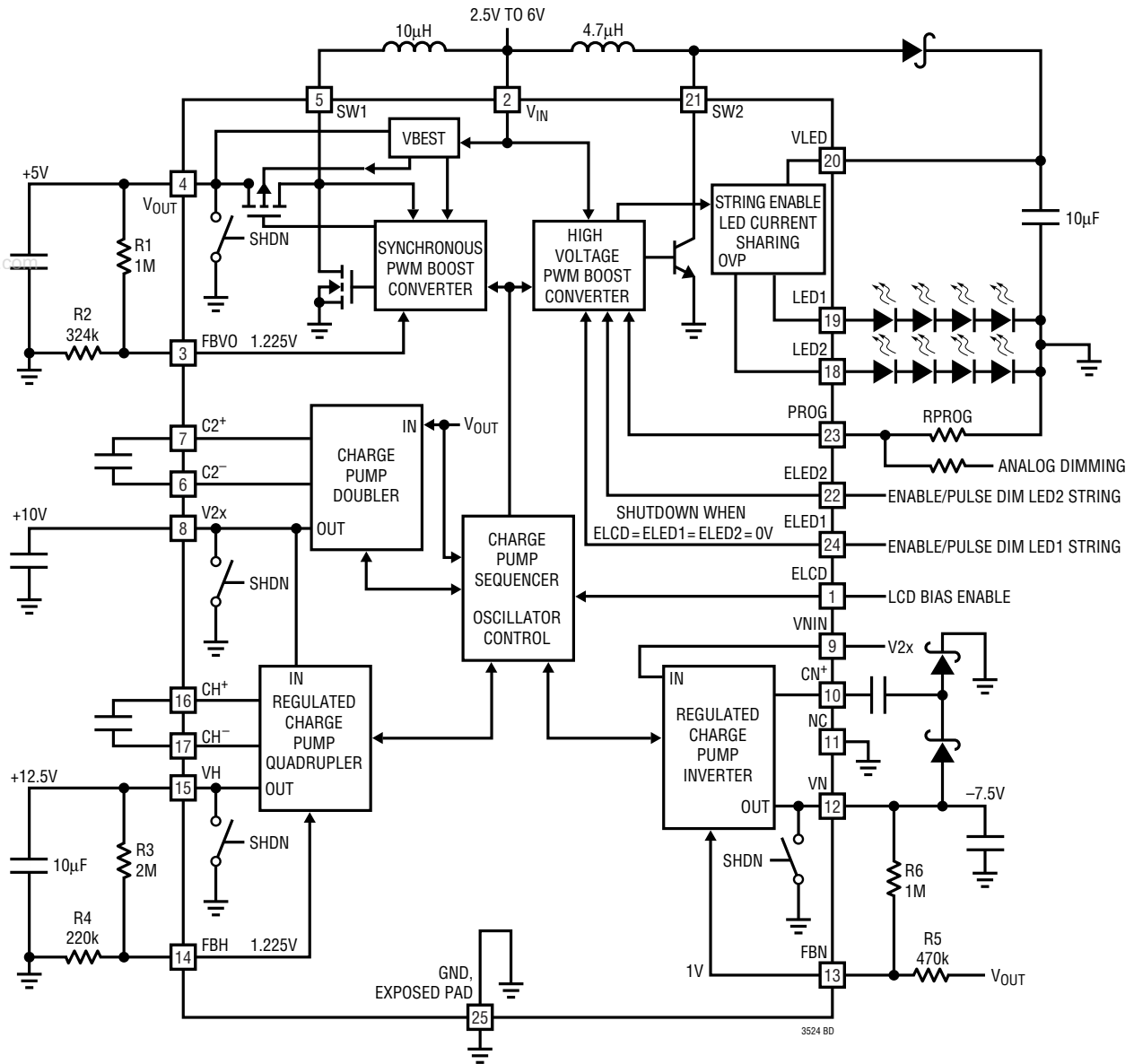

OPERATION

The LTC3524 is a highly integrated power converter intended for small to medium-sized TFT LCD display modules. The part generates the required bias voltages for the LCD panel as well as regulated current for one or two white LED backlight strings. The LCD bias and white LED boost converters are powered from a common input voltage between 2.5V and 6V and share a 1.5MHz oscillator, allowing tiny inductors and capacitors to be used. The LCD bias supply and each white LED string can be independently enabled and a low current shutdown mode ($<2\mu\text{A}$) is activated when all outputs are disabled.

The LCD bias includes a synchronous PWM boost converter that can be programmed between 3.0V and 6.0V. This output (V_{OUT}) is used as the main LCD supply and to power three charge pump converters. The charge pump circuits operate at one-sixteenth the boost frequency (about 94kHz). The generated output voltages are internally sequenced to insure proper initialization of the LCD panel. A digital shutdown input (ELCD) rapidly discharges each generated output voltage to provide a near instantaneous turn-off of the LCD display.

The white LED driver circuitry consists of a PWM boost converter with an internal low loss NPN power switch and external Schottky diode. The LED boost output (V_{LED}) can power as many as ten white LEDs at up to 25mA. LED current is programmable and current in each string matched with an internal loop. PWM dimming can be implemented through the enable pins (ELED1 and ELED2) to extend the dimming range of the application.

LCD Bias Boost Converter

A synchronous boost converter is used to generate the main analog LCD bias supply for the TFT display. The converter utilizes current mode control and includes internally set control loop and slope compensation for optimized performance and a simple design. Only an inductor, output capacitor and V_{OUT} programming resistors at FBVO are required to complete the design of the 25mA boost. The 1.5MHz operating frequency produces very low output ripple and allows the use of small low profile inductors and tiny external ceramic capacitors. The boost converter also disconnects its output from V_{IN}

during shutdown to avoid loading the input power source. Soft-start produces a controlled ramp of the converter input current during start-up, greatly reducing the burden on the input power source. Very low operating quiescent current and synchronous operation allow for greater than 90% conversion efficiency.

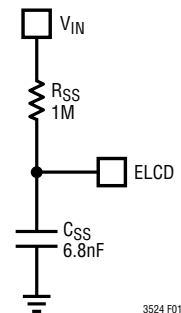

Figure 1. 1ms Soft-Start with 3.6V V_{IN}

Soft-start operation provides a gradual increase in the current drawn from the input power source during initial start-up of the LCD bias boost converter. The rate at which the input current will increase is set by two external components (R_{SS} and C_{SS}) connected to ELCD (refer to Figure 2). Upon initial application of power the voltage on ELCD will increase relative to the time constant $R_{\text{SS}} \times C_{\text{SS}}$. After one time constant, ELCD will rise to approximately 63.2% of the voltage on V_{IN} . From 0V to approximately 0.65V on ELCD, no switching will occur because the threshold is 0.65V (typ). From 0.65V to 1V the maximum switch pin current capability of the LTC3524 will gradually increase from near 0A to the maximum current limit.

LCD Bias Charge Pumps

The LTC3524 uses three internal charge pump circuits to generate low current, high voltage outputs typically used to bias the LCD gate drive. The three charge pumps include a doubler, quadrupler, and inverting configuration. Each charge pump requires two small external capacitors, one to transfer charge, and one for filtering. The charge pumps feature fixed frequency operation for high efficiency and lowest noise performance. The charge pump converters operate at one-sixteenth the boost converter frequency.

OPERATION

The doubler is internally connected to V_{OUT} and generates a voltage of approximately $2X V_{OUT}$ at $V2x$. The quadrupler has its input connected to $V2x$ and output to VH . The regulated VH voltage is programmed at FBH and can be set to produce a voltage up to $4X V_{OUT}$. The maximum voltage VH can source depends on charge pump loading and the output impedance of the doubler and quadrupler stages (see Typical Performance Characteristics).

The inverting charge pump has its input at VN_{IN} and output at VN . Regulated VN voltage is set at FBN and can be programmed to a minimum negative voltage of VN_{IN} minus diode drops. VN_{IN} can be connected to V_{OUT} , $V2x$, or VH depending on the negative voltage value required for the application. Efficiency is improved by using the lowest voltage possible on VN_{IN} . As with the other charge pump outputs, the maximum negative voltage that VN can maintain will depend on loading. Two Schottky diodes are required to complete the negative charge pump as shown on the front page and applications circuits.

LCD BIAS Sequencing

Referring to the following text and Figure 2, the LTC3524 power-up and discharge sequence is explained. When input power is applied and $ELCD$ is active, the boost converter initializes and charges its output towards the final programmed value. When the boost converter output (V_{OUT}) has reached approximately 90% of its final value, an internal signal is asserted which allows the charge pump doubler

($V2x$) to begin operation toward its final goal of $2X V_{OUT}$. Approximately 2ms later, the charge pump inverter (VN) begins operation toward its programmed value. When the VN has reached approximately 50% of its final value, a 2ms (nominal) timeout period begins. At the conclusion of the 2ms timeout period, the charge pump quadrupler (VH) is allowed to begin operation.

During the initial power-up sequence, the charge pumps run at half speed. If VN_{IN} is connected to VH , a diode-OR circuit is needed between $V2x$, VH , and VN_{IN} (see the Typical Applications) to ensure proper sequencing.

When $ELCD$ is brought low, internal transistors discharge the outputs in an orderly fashion. As shown in Figure 2, VN and $V2x$ are initially discharged, followed by VH , followed by V_{OUT} . V_{OUT} must be discharged before the part can enter low current shutdown mode ($ELCD$, $ELED1$, $ELED2$ must be low, as well).

White LED Boost Driver

The white LED driver portion of the LTC3524 consists of a nonsynchronous, fixed frequency, current mode boost converter that generates the voltage required for one or two LED strings. The converter has an internal feedback loop and slope compensation circuitry, reducing external components and simplifying the design. As with the LCD bias boost converter, the 1.5MHz operation allows tiny external components to be used. The boost converter

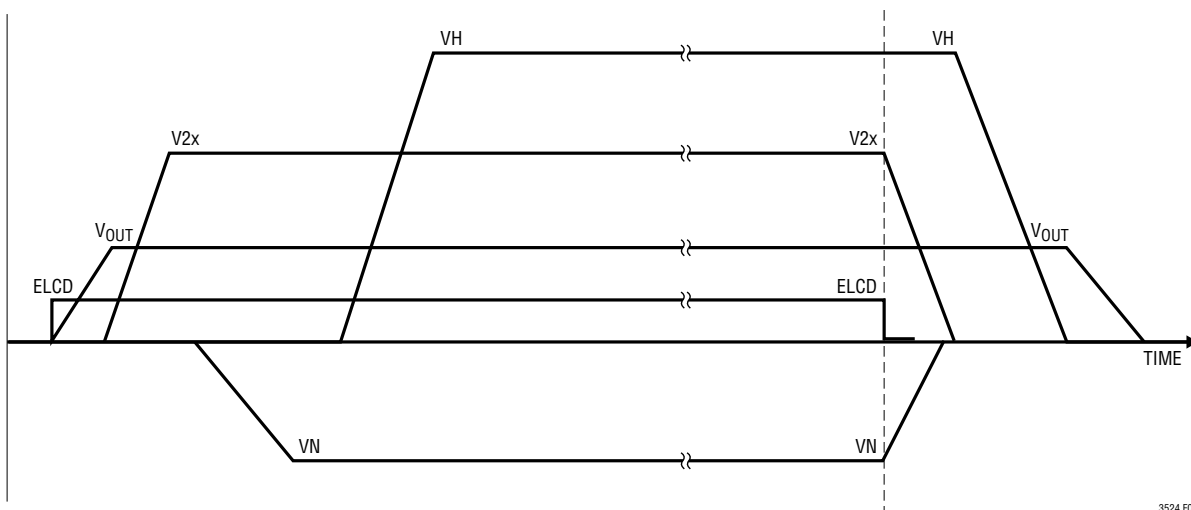

Figure 2. LCD Power-Up and Power-Down Timing Diagram

3524 F02

OPERATION

output voltage is not set to a fixed voltage, but rather controlled to produce the programmed current in the LED strings. The output (VLED) is rated for a maximum of 21V which will support two strings of up to five series LED in most cases.

The boost output is used to power one or two white LED strings with a common ground. If only one string is enabled (ELED1 or ELED2) the voltage on that string (LED1 or LED2) will be controlled to regulate the LED current set at the PROG pin. The voltage on VLED will be slightly greater due to the overhead needed for the internal sense element and share circuitry. For example, a single string application with four white LEDs programmed at 20mA would require 14.4V on LED1 if the forward drop on each LED is 3.6V. The voltage on VLED may need to be 15V to support the drops on the internal share circuitry. For applications with five or fewer LED elements, a single-string operation will provide better efficiency.

If both strings are enabled, the boost output (VLED) will generate the voltage required to regulate current in the higher voltage string. Voltage on the lower string is controlled by the internal share circuit to provide the programmed current. The LTC3524 achieves current matching between the strings while minimizing the voltage drop between VLED and the higher voltage string (to maintain high efficiency). For example, an application with four LEDs on LED1 and five LEDs on LED2 is programmed for 20mA ($R_{PROG} = 100k$). In this instance, assuming a 3.6V forward drop, LED1 is 14.4V, LED2 is 18V, and VLED is 18.6V. The drop between VLED and LED1 is 4V at 20mA, resulting in lower efficiency. For this reason, it is recommended when possible to keep the number of LEDs in each string matched.

Analog Dimming:

The LTC3524's white LED driver allows both analog and PWM dimming to be implemented. Analog dimming provides a lower noise solution but a reduced dynamic range. Analog dimming can be implemented by resistively summing a current into the PROG pin. The LED string currents with R_{PROG} , V_{SUM} , and R_{SUM} will be:

$$I_{LED} = 1625 \cdot \left(\frac{1.225V}{R_{PROG}} + \frac{1.225V - V_{SUM}}{R_{SUM}} \right)$$

A 0V to 3V V_{SUM} with $R_{SUM} = 300k$ and $R_{PROG} = 150k$ will produce LED currents between 3mA and 20mA.

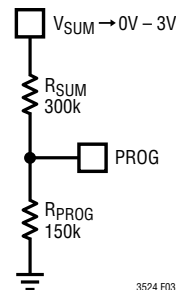

Figure 3. Analog Dimming Circuit Using V_{SUM}

True Color PWM Dimming:

PWM dimming can be implemented by enabling and disabling the LED strings with ELED1 and ELED2. A PWM frequency between 100Hz and 500Hz is generally recommended to get wide dimming range while operating at a frequency faster than the eye can detect. For best results, the LCD bias portion of the device should be enabled (to keep the device out of shutdown) and ELED1 and ELED2 should be driven with a common low frequency PWM signal. PWM dimming waveforms are shown in the Typical Performance Characteristics section of this datasheet.

The achievable dimming range is dependant on the PWM dimming frequency (F_{PWM}) and the settling time of the LED strings when enabled (T_{SETTLE}). The minimum duty cycle (or light output) that the strings can be controlled to is given by:

$$\text{MinDuty} = F_{PWM} \cdot T_{SETTLE}$$

For example, if the settling time is 50 μ S and the PWM frequency is 100Hz, the minimum duty cycle is 0.5% which corresponds to a 200:1 dimming range.

Open LED:

The LTC3524 has internal over voltage protection in the event that one of the white LED strings becomes open circuited. If VLED reaches 24V (nominal) due to an open circuit on either string, the boost converter will regulate at 24V while current in the remaining string (if enabled) is controlled to the programmed value.

APPLICATIONS INFORMATION

Inductor Selection

3.3 μ H to 15 μ H inductors are recommended for use with the LTC3524's two boost converters. The synchronous LCD bias boost inductor should have a saturation current (I_{SAT}) rating of at least 150mA, where the nonsynchronous white LED boost inductor should have a rating of at least 600mA. In most applications, the inductor value for the LCD bias will be larger (10 μ H to 15 μ H) to prevent operation in deep discontinuous mode. The inductor value for the white LED can be smaller (3.3 μ H to 6.8 μ H), since it operates at higher currents. Ferrite core materials are strongly recommended for their superior high frequency performance characteristics. Inductors meeting these requirements are listed in Table 1. The maximum current and DCR ranges in the table correspond to the respective Inductance range (for example, the 3.3 μ H inductor

will have the highest maximum current and lowest DCR). Shielded inductor series parts are in **bold text**.

The V_{IN} input capacitor should be an X5R type of at least 2.2 μ F using a low impedance connection to the battery. The VLED output capacitor should be X5R type and at least 1 μ F for analog dimming and 4.7 μ F for PWM dimming. The V_{OUT} capacitor should also be an X5R type between 2.2 μ F and 10 μ F. A larger capacitor (10 μ F) should be used if lower output ripple is desired or the output load required is close to the 25mA maximum.

The charge pumps require flying capacitors ($C2^+$ to $C2^-$, CN^+ , and CH^+ to CH^-) that should be at least 0.1 μ F to obtain specified performance. Ceramic X5R types are strongly recommended for their low ESR and ESL and capacitance vs bias voltage stability. The filter capacitors on V2x, VN,

Table 1. Recommended Inductors

PART	L (μ H)	MAXIMUM CURRENT (mA)	DCR (Ω)	DIMENSIONS (mm) (L \times W \times H)	MANUFACTURER
ME3220	3.3-15	1300-700	0.14-0.52	3.2 \times 2.5 \times 2.0	Coil Craft www.coilcraft.com
LP03010	3.3-10	950-570	0.2-0.52	3.0 \times 3.0 \times 1.0	
MSS4020	3.3-15	1100-440	0.09-0.33	4.0 \times 4.0 \times 2.0	
SD3112	3.3-15	970-405	0.16-0.65	3.1 \times 3.1 \times 1.2	Cooper www.cooperet.com
MIP3226D	3-10	1000-200	0.1-0.16	3.2 \times 2.6 \times 1.0	FDK www.fdk.com
LQH32CN	4.7-15	650-300	0.15-0.58	3.2 \times 2.5 \times 1.5	Murata www.murata.com
LQH2MC	4.7-15	300-200	0.8-1.6	2 \times 1.6 \times 0.9	
CDRH3D16	3.3-15	1100-520	0.09-0.41	3.8 \times 3.8 \times 1.8	Sumida www.sumida.com
CDRH2D14	3.3-12	820-420	0.12-0.32	3.2 \times 3.2 \times 1.5	
NR3010	3.3-15	750-400	0.16-0.74	3.0 \times 3.0 \times 1.0	Taiyo Yuden www.t-yuden.com
NR3015	3.3-15	1200-560	0.1-0.36	3.0 \times 3.0 \times 1.5	

APPLICATIONS INFORMATION

and VH should be at least $0.47\mu\text{F}$. Please be certain that the capacitors used are rated for the maximum voltage with adequate safety margin. Refer to Table 2 for a listing of capacitor vendors.

Table 2. Capacitor Vendor Information

Supplier	Phone	Website
AVX	(803) 448-9411	www.avxcorp.com
Murata	(714) 852-2001	www.murata.com
Samsung	(408) 544-5200	www.sem.samsung.com
Taiyo Yuden	(800) 368-2496	www.t-yuden.com
TDK	(847) 803-6100	www.component.tdk.com

Printed Circuit Board Layout Guidelines

High-speed operation of the LTC3524 demands careful attention to PCB layout. You will not get advertised performance with a careless layout. Figure 4 shows the recommended component placement for a double layer PCB. The bottom layer is used as a common ground plane except for the VN trace.

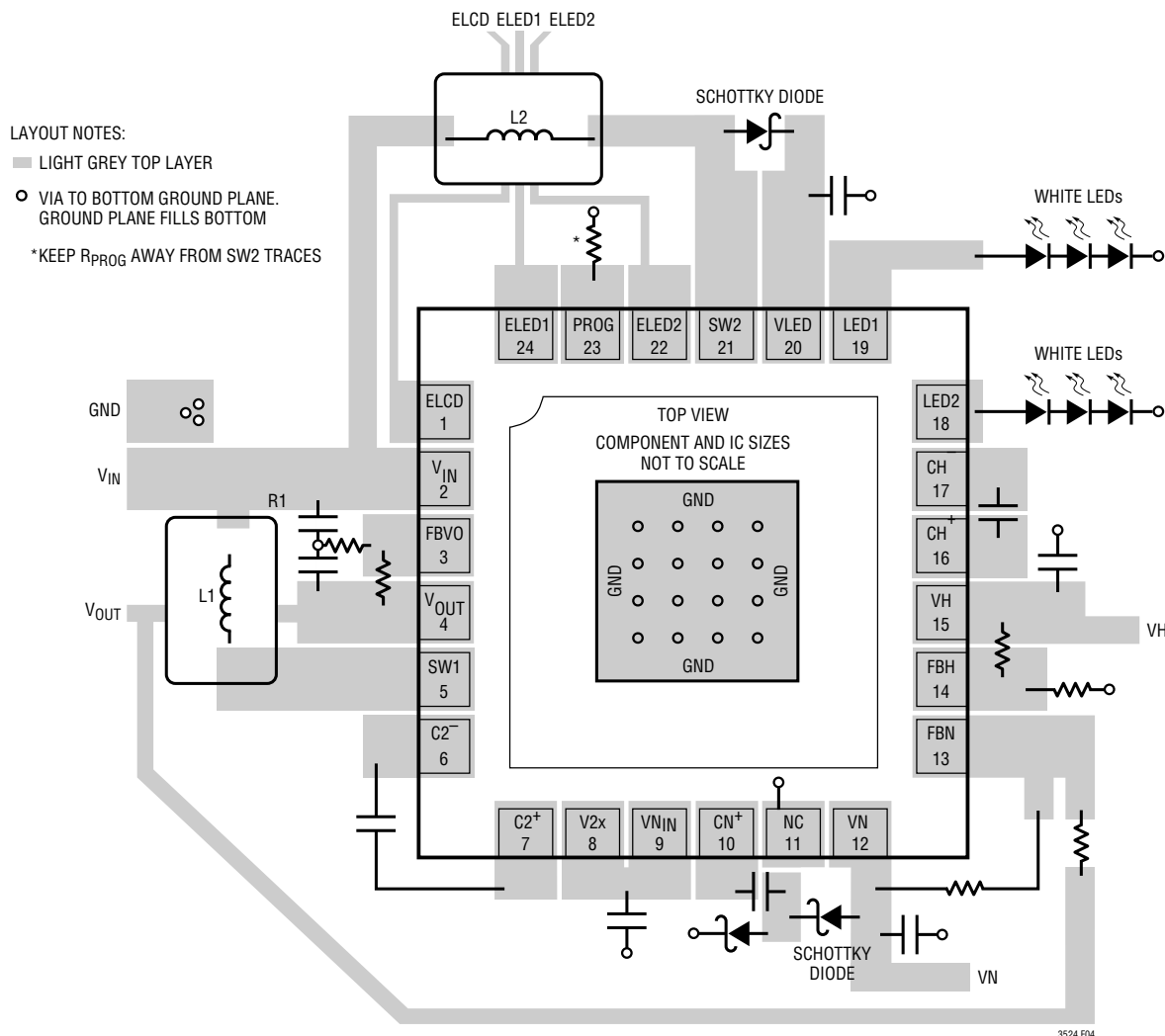
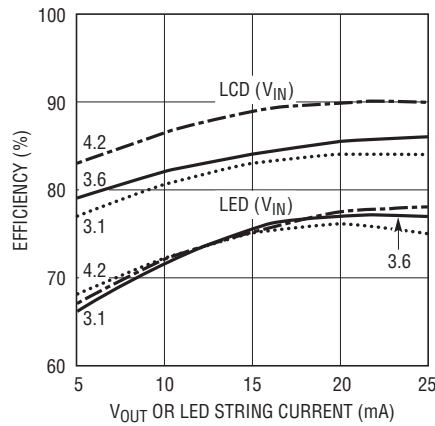
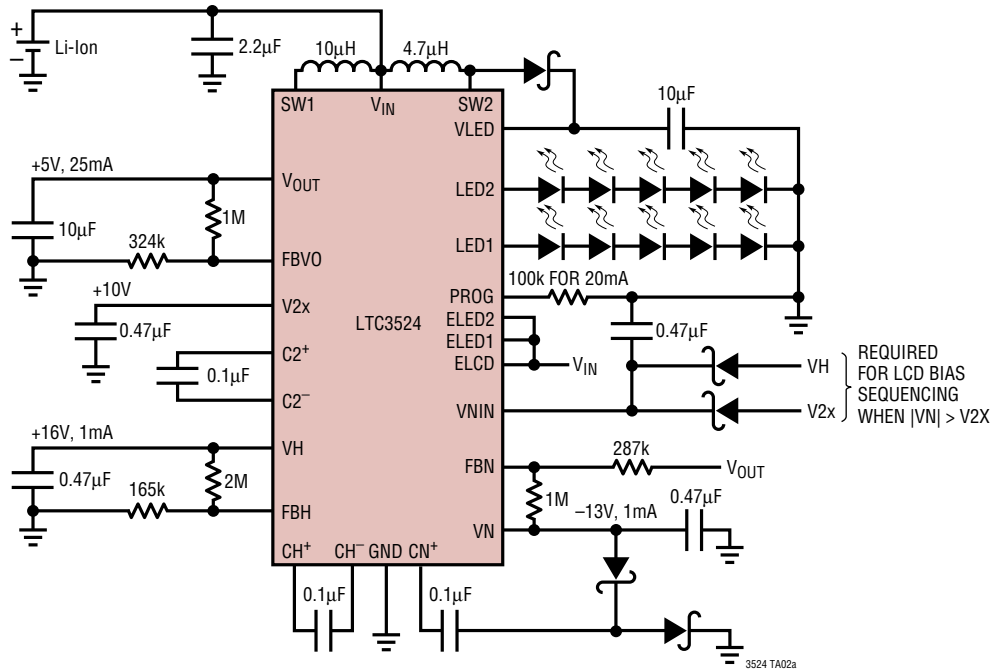

Figure 4. Suggested Layout Two Layer Board (Not to Scale)

TYPICAL APPLICATIONS

Li-Ion to +5V, 25mA, +16V, 1mA, -13V, 1mA TFT LCD Power Supply + 10 White LEDs



PACKAGE DESCRIPTION

UF Package
24-Lead Plastic QFN (4mm × 4mm)
 (Reference LTC DWG # 05-08-1697)

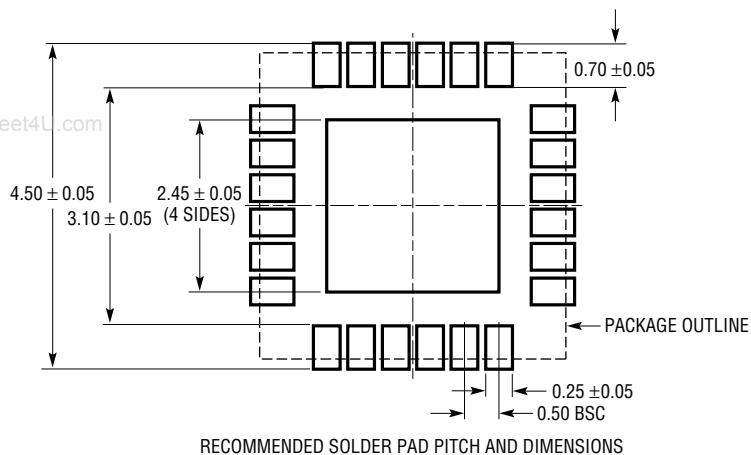

RECOMMENDED SOLDER PAD PITCH AND DIMENSIONS

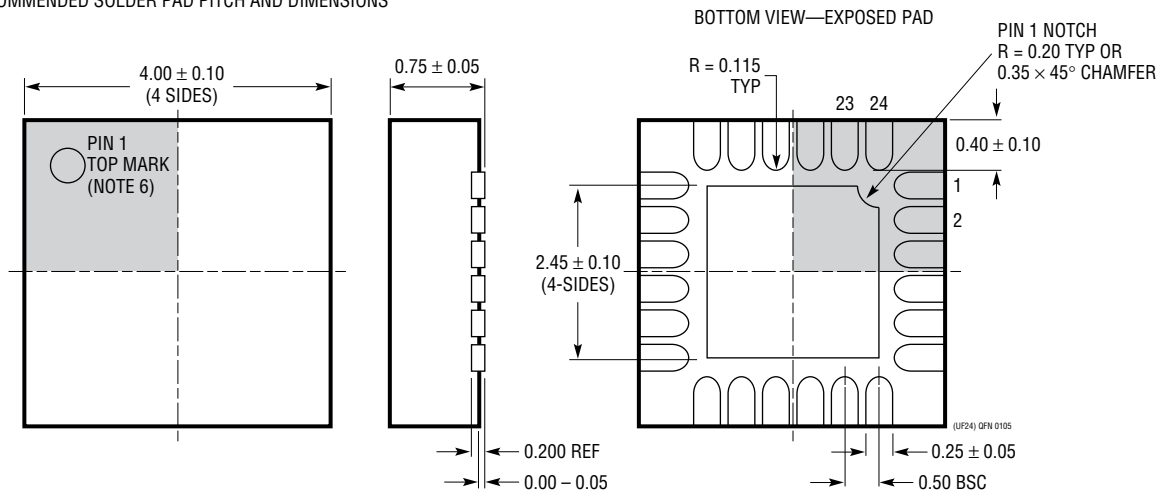

NOTE:

1. DRAWING PROPOSED TO BE MADE A JEDEC PACKAGE OUTLINE MO-220 VARIATION (WGGD-X)—TO BE APPROVED
2. DRAWING NOT TO SCALE
3. ALL DIMENSIONS ARE IN MILLIMETERS
4. DIMENSIONS OF EXPOSED PAD ON BOTTOM OF PACKAGE DO NOT INCLUDE MOLD FLASH. MOLD FLASH, IF PRESENT, SHALL NOT EXCEED 0.15mm ON ANY SIDE, IF PRESENT
5. EXPOSED PAD SHALL BE SOLDER PLATED
6. SHADED AREA IS ONLY A REFERENCE FOR PIN 1 LOCATION ON THE TOP AND BOTTOM OF PACKAGE

TYPICAL APPLICATION

3NiMH or NiCD to +3.3V, 25mA, +10V, 1mA, -5V, 1mA TFT LCD Power Supply + 6 White LEDs

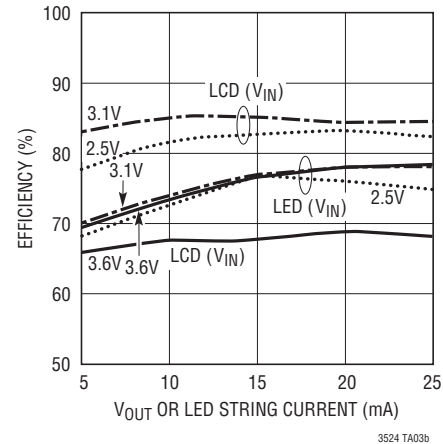
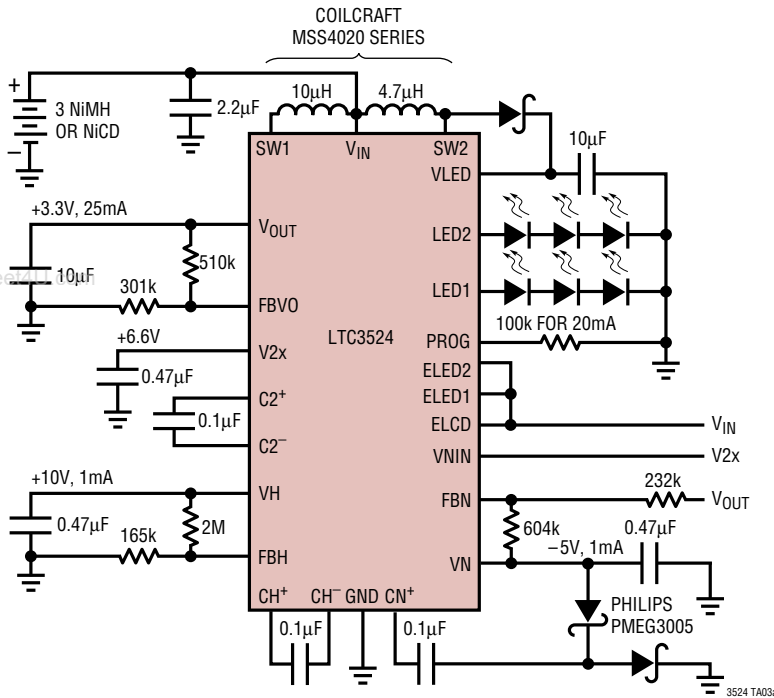

RELATED PARTS

PART NUMBER	DESCRIPTION	COMMENTS
LT1942	Quad DC/DC Converter for Triple Output TFT Supply Plus LED Driver	V _{IN} : 2.6V to 16V, V _{OUT(MAX)} = 36V, I _Q = 7mA, I _{SD} = < 1µA, 4mm × 4mm QFN-24 Package
LT1947	3MHz, 30V Adjustable Output TFT-LCD	V _{IN} : 2.7V to 8V, V _{OUT(MAX)} = 30V, I _Q = 9.5mA, I _{SD} = < 1µA, MSOP-10 Package
LTC3450	Triple Switching Regulator	V _{IN} : 1.5V to 4.6V, V _{OUT(MAX)} = 15V, I _Q = 75µA, I _{SD} = < 1µA, 3mm × 3mm QFN-16 Package
LT3465/LT3465A	Constant-Current, 1.2MHz/2.7MHz High Efficiency White LED Boost Regulator with Integrated Schottky Diode	V _{IN} : 2.7V to 16V, V _{OUT(MAX)} = 34V, I _Q = 1.9mA, I _{SD} = < 1µA, ThinSOT™ Package
LT3466/LT3466-1	Dual Constant-Current, 2MHz, High Efficiency White LED Boost Regulator with Integrated Schottky Diode	V _{IN} : 2.7V to 24V, V _{OUT(MAX)} = 40V, I _Q = 5mA, I _{SD} = < 16µA, 3mm × 3mm DFN-10 Package
LT3471	Dual Output, Boost/Inverter, 1.3A I _{SW} , 1.2MHz, High Efficiency Boost-Inverting DC/DC Converter	V _{IN} : 2.4V to 16V, V _{OUT(MAX)} = ±40V, I _Q = 2.5mA, I _{SD} = < 1µA, 3mm × 3mm DFN-10 Package
LT3491	Constant-Current, 2.3MHz, High Efficiency White LED Boost Regulator with Integrated Schottky Diode	V _{IN} : 2.5V to 12V, V _{OUT(MAX)} = 27V, I _Q = 2.6mA, I _{SD} = < 8µA, 2mm × 2mm DFN-6 SC70 Package
LT3494/LT3494A	40V, 180mA/350mA Micropower Low Noise Boost Converter with Output Disconnect	V _{IN} : 2.3V to 16V, V _{OUT(MAX)} = 40V, I _Q = 65µA, I _{SD} = < 1µA, 3mm × 2mm DFN-8 Package
LT3497	Constant-Current, 2.3MHz, Dual High Efficiency White LED Boost Regulator with Integrated Schottky Diode for 12 LEDs	V _{IN} : 2.5V to 10V, V _{OUT(MAX)} = 32V, I _Q = 6mA, I _{SD} = < 12µA, 3mm × 2mm DFN-10 Package
LT3591	Constant-Current, 1MHz, High Efficiency White LED Boost Regulator with Integrated Schottky Diode	V _{IN} : 2.5V to 12V, V _{OUT(MAX)} = 40V, I _Q = 4mA, I _{SD} = < 9µA, 3mm × 2mm DFN-8 Package

ThinSOT is a trademark of Linear Technology Corporation.