

To all our customers

Regarding the change of names mentioned in the document, such as Hitachi Electric and Hitachi XX, to Renesas Technology Corp.

The semiconductor operations of Mitsubishi Electric and Hitachi were transferred to Renesas Technology Corporation on April 1st 2003. These operations include microcomputer, logic, analog and discrete devices, and memory chips other than DRAMs (flash memory, SRAMs etc.) Accordingly, although Hitachi, Hitachi, Ltd., Hitachi Semiconductors, and other Hitachi brand names are mentioned in the document, these names have in fact all been changed to Renesas Technology Corp. Thank you for your understanding. Except for our corporate trademark, logo and corporate statement, no changes whatsoever have been made to the contents of the document, and these changes do not constitute any alteration to the contents of the document itself.

Renesas Technology Home Page: <http://www.renesas.com>

Renesas Technology Corp.
Customer Support Dept.
April 1, 2003

Cautions

Keep safety first in your circuit designs!

1. Renesas Technology Corporation puts the maximum effort into making semiconductor products better and more reliable, but there is always the possibility that trouble may occur with them. Trouble with semiconductors may lead to personal injury, fire or property damage.
Remember to give due consideration to safety when making your circuit designs, with appropriate measures such as (i) placement of substitutive, auxiliary circuits, (ii) use of nonflammable material or (iii) prevention against any malfunction or mishap.

Notes regarding these materials

1. These materials are intended as a reference to assist our customers in the selection of the Renesas Technology Corporation product best suited to the customer's application; they do not convey any license under any intellectual property rights, or any other rights, belonging to Renesas Technology Corporation or a third party.
2. Renesas Technology Corporation assumes no responsibility for any damage, or infringement of any third-party's rights, originating in the use of any product data, diagrams, charts, programs, algorithms, or circuit application examples contained in these materials.
3. All information contained in these materials, including product data, diagrams, charts, programs and algorithms represents information on products at the time of publication of these materials, and are subject to change by Renesas Technology Corporation without notice due to product improvements or other reasons. It is therefore recommended that customers contact Renesas Technology Corporation or an authorized Renesas Technology Corporation product distributor for the latest product information before purchasing a product listed herein.
The information described here may contain technical inaccuracies or typographical errors.
Renesas Technology Corporation assumes no responsibility for any damage, liability, or other loss rising from these inaccuracies or errors.
Please also pay attention to information published by Renesas Technology Corporation by various means, including the Renesas Technology Corporation Semiconductor home page (<http://www.renesas.com>).
4. When using any or all of the information contained in these materials, including product data, diagrams, charts, programs, and algorithms, please be sure to evaluate all information as a total system before making a final decision on the applicability of the information and products. Renesas Technology Corporation assumes no responsibility for any damage, liability or other loss resulting from the information contained herein.
5. Renesas Technology Corporation semiconductors are not designed or manufactured for use in a device or system that is used under circumstances in which human life is potentially at stake. Please contact Renesas Technology Corporation or an authorized Renesas Technology Corporation product distributor when considering the use of a product contained herein for any specific purposes, such as apparatus or systems for transportation, vehicular, medical, aerospace, nuclear, or undersea repeater use.
6. The prior written approval of Renesas Technology Corporation is necessary to reprint or reproduce in whole or in part these materials.
7. If these products or technologies are subject to the Japanese export control restrictions, they must be exported under a license from the Japanese government and cannot be imported into a country other than the approved destination.
Any diversion or reexport contrary to the export control laws and regulations of Japan and/or the country of destination is prohibited.
8. Please contact Renesas Technology Corporation for further details on these materials or the products contained therein.

PCI Interface Board (HS6000EIC02H) for E6000 Emulator or E8000 Emulator

User's Manual



ADE-702-323

Rev. 1.0

07/08/02

Hitachi, Ltd.

Cautions

1. Hitachi neither warrants nor grants licenses of any rights of Hitachi's or any third party's patent, copyright, trademark, or other intellectual property rights for information contained in this document. Hitachi bears no responsibility for problems that may arise with third party's rights, including intellectual property rights, in connection with use of the information contained in this document.
2. Products and product specifications may be subject to change without notice. Confirm that you have received the latest product standards or specifications before final design, purchase or use.
3. Hitachi makes every attempt to ensure that its products are of high quality and reliability. However, contact Hitachi's sales office before using the product in an application that demands especially high quality and reliability or where its failure or malfunction may directly threaten human life or cause risk of bodily injury, such as aerospace, aeronautics, nuclear power, combustion control, transportation, traffic, safety equipment or medical equipment for life support.
4. Design your application so that the product is used within the ranges guaranteed by Hitachi particularly for maximum rating, operating supply voltage range, heat radiation characteristics, installation conditions and other characteristics. Hitachi bears no responsibility for failure or damage when used beyond the guaranteed ranges. Even within the guaranteed ranges, consider normally foreseeable failure rates or failure modes in semiconductor devices and employ systemic measures such as fail-safes, so that the equipment incorporating Hitachi product does not cause bodily injury, fire or other consequential damage due to operation of the Hitachi product.
5. This product is not designed to be radiation resistant.
6. No one is permitted to reproduce or duplicate, in any form, the whole or part of this document without written approval from Hitachi.
7. Contact Hitachi's sales office for any questions regarding this document or Hitachi semiconductor products.

IMPORTANT INFORMATION

READ FIRST

- **READ** this user's manual before using this emulator product.
- **KEEP** the user's manual handy for future reference.

Do not attempt to use the emulator product until you fully understand its mechanism.

Emulator Product:

Throughout this document, the term "emulator product" shall be defined as the following products produced only by Hitachi, Ltd. excluding all subsidiary products.

- E6000 series emulator station or E8000 series emulator station
- PCI interface board
- User system interface cables
- SIMM memory module
- Optional boards

The user system or a host computer is not included in this definition.

Purpose of the PCI Interface Board:

This PCI interface board is for connecting an E6000 series emulator or an E8000 series emulator to a host computer, and supports software and hardware development. This PCI interface board must only be used for the above purpose.

Improvement Policy:

Hitachi, Ltd. (including its subsidiaries, hereafter collectively referred to as Hitachi) pursues a policy of continuing improvement in design, functions, performance, and safety of the emulator product. Hitachi reserves the right to change, wholly or partially, the specifications, design, user's manual, and other documentation at any time without notice.

Target User of the Emulator Product:

This emulator product should only be used by those who have carefully read and thoroughly understood the information and restrictions contained in the user's manual. Do not attempt to use the emulator product until you fully understand its mechanism.

It is highly recommended that first-time users be instructed by users that are well versed in the operation of the emulator product.

LIMITED WARRANTY

Hitachi warrants its emulator products to be manufactured in accordance with published specifications and free from defects in material and/or workmanship. Hitachi, at its option, will repair or replace any emulator products returned intact to the factory, transportation charges prepaid, which Hitachi, upon inspection, determine to be defective in material and/or workmanship. The foregoing shall constitute the sole remedy for any breach of Hitachi's warranty. See the Hitachi warranty booklet for details on the warranty period. This warranty extends only to you, the original Purchaser. It is not transferable to anyone who subsequently purchases the emulator product from you. Hitachi is not liable for any claim made by a third party or made by you for a third party.

DISCLAIMER

HITACHI MAKES NO WARRANTIES, EITHER EXPRESS OR IMPLIED, ORAL OR WRITTEN, EXCEPT AS PROVIDED HEREIN, INCLUDING WITHOUT LIMITATION THEREOF, WARRANTIES AS TO MARKETABILITY, MERCHANTABILITY, FITNESS FOR ANY PARTICULAR PURPOSE OR USE, OR AGAINST INFRINGEMENT OF ANY PATENT. IN NO EVENT SHALL HITACHI BE LIABLE FOR ANY DIRECT, INCIDENTAL OR CONSEQUENTIAL DAMAGES OF ANY NATURE, OR LOSSES OR EXPENSES RESULTING FROM ANY DEFECTIVE EMULATOR PRODUCT, THE USE OF ANY EMULATOR PRODUCT, OR ITS DOCUMENTATION, EVEN IF ADVISED OF THE POSSIBILITY OF SUCH DAMAGES. EXCEPT AS EXPRESSLY STATED OTHERWISE IN THIS WARRANTY, THIS EMULATOR PRODUCT IS SOLD "AS IS", AND YOU MUST ASSUME ALL RISK FOR THE USE AND RESULTS OBTAINED FROM THE EMULATOR PRODUCT.

State Law:

Some states do not allow the exclusion or limitation of implied warranties or liability for incidental or consequential damages, so the above limitation or exclusion may not apply to you. This warranty gives you specific legal rights, and you may have other rights which may vary from state to state.

The Warranty is Void in the Following Cases:

Hitachi shall have no liability or legal responsibility for any problems caused by misuse, abuse, misapplication, neglect, improper handling, installation, repair or modifications of the emulator product without Hitachi's prior written consent or any problems caused by the user system.

All Rights Reserved:

This user's manual and emulator product are copyrighted and all rights are reserved by Hitachi. No part of this user's manual, all or part, may be reproduced or duplicated in any form, in hard-copy or machine-readable form, by any means available without Hitachi's prior written consent.

Other Important Things to Keep in Mind:

1. Circuitry and other examples described herein are meant merely to indicate the characteristics and performance of Hitachi's semiconductor products. Hitachi assumes no responsibility for any intellectual property claims or other problems that may result from applications based on the examples described herein.
2. No license is granted by implication or otherwise under any patents or other rights of any third party or Hitachi.

Figures:

Some figures in this user's manual may show items different from your actual system.

Limited Anticipation of Danger:

Hitachi cannot anticipate every possible circumstance that might involve a potential hazard. The warnings in this user's manual and on the emulator product are therefore not all inclusive. Therefore, you must use the emulator product safely at your own risk.

SAFETY PAGE

READ FIRST

- **READ** this user's manual before using this emulator product.
- **KEEP** the user's manual handy for future reference.

Do not attempt to use the emulator product until you fully understand its mechanism.

DEFINITION OF SIGNAL WORDS



This is the safety alert symbol. It is used to alert you to potential personal injury hazards. Obey all safety messages that follow this symbol to avoid possible injury or death.



DANGER indicates an imminently hazardous situation which, if not avoided, will result in death or serious injury.



WARNING indicates a potentially hazardous situation which, if not avoided, could result in death or serious injury.



CAUTION indicates a potentially hazardous situation which, if not avoided, may result in minor or moderate injury.



CAUTION used without the safety alert symbol indicates a potentially hazardous situation which, if not avoided, may result in property damage.

NOTE emphasizes essential information.

WARNING

Observe the precautions listed below. Failure to do so will result in a FIRE HAZARD and will damage the user system and the emulator product or will result in PERSONAL INJURY. The USER PROGRAM will be LOST.

- 1. Do not repair or remodel the emulator product by yourself for electric shock prevention and quality assurance.**
- 2. Always switch OFF the E6000 emulator and user system before connecting or disconnecting any CABLES or PARTS.**
- 3. Always before connecting any CABLES, make sure that pin 1 on both sides are correctly aligned.**

Contents

Section 1 Specifications.....	1
Section 2 Components	3
Section 3 Preparation Before Use.....	4
3.1 Installing PCI Interface Board	4
3.2 Connecting PCI Interface Board to E6000 Emulator.....	5
3.3 Connecting PCI Interface Board to E8000 Emulator.....	6
Section 4 Start Up.....	7

Thank you for purchasing the PCI interface board for the E6000 emulator or the E8000 emulator. A personal computer with PCI bus specifications can be connected to the E6000 emulator or the E8000 emulator as the host computer by installing the PCI interface board in the personal computer.

Section 1 Specifications

The specifications of the PCI interface board are listed in table 1 and its environmental conditions in table 2. The board's dimensions are shown in figure 1.

Table 1 PCI Interface Board Specifications

Item	Specification
Target host computer	IBM PC conforming to a PCI slot or its compatible computer
OS	Microsoft® Windows NT®, Windows® 95, or Windows® 98 operating system
Memory requirement	16 kbytes
PCI bus specifications	Conforms to revision 2.1

Table 2 Environmental Conditions

Item	Specification
Temperature	At operation: 10 to 35°C Non-operation: -10 to 50°C
Humidity	At operation: 35 to 80%RH (no condensation) Non-operation: 35 to 80% RH (no condensation)
Vibration	At operation: 2.45 m/s ² max Non-operation: 4.9 m/s ² max At shipment: 14.7 m/s ² max
Ambient gasses	No corrosive gas allowed
Voltage	5 V ± 5 %
Current consumption	500 mA max

- Notes:**
- 1. IBM PC is a registered trademark of International Business Machines Corporation.**
 - 2. Microsoft®, Windows®, and Windows NT® are registered trademarks of Microsoft Corporation in the United States and/or in other countries.**

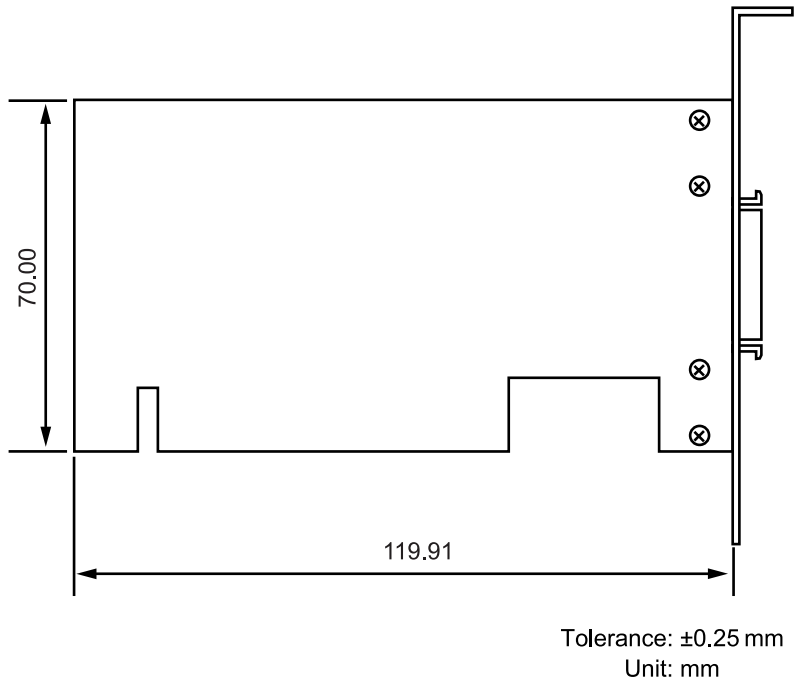
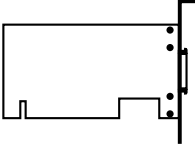



Figure 1 HS6000EIC02H Dimensions

Section 2 Components

Table 3 lists the components of the PCI interface board.

Table 3 Components

Item	Product Name	Configuration	Quantity	Remarks
Hardware	PCI interface board		1	Printed circuit board: 1
	PC interface cable		1	Cable length: 1.5 m With a ferrite core (for EMI* disturbance)
Documentation	Description Notes on Using PCI Interface Board (HS6000EIC02H) (This manual)		1	HS6000EIC02HE(A)

Note: EMI is an abbreviation of electrical magnetic interference.

Section 3 Preparation Before Use

3.1 Installing PCI Interface Board

WARNING

Always switch OFF the emulator product, system, and host computer before connecting or disconnecting the PCI interface board. Failure to do so will result in a FIRE HAZARD and will damage the user system, host computer, and emulator product or will result in PERSONAL INJURY.

Open the host computer cover and install the PCI interface board into an extension slot conforming to PCI bus specifications. Gently push the PCI interface board into the connector and fasten the board with the host computer screw.

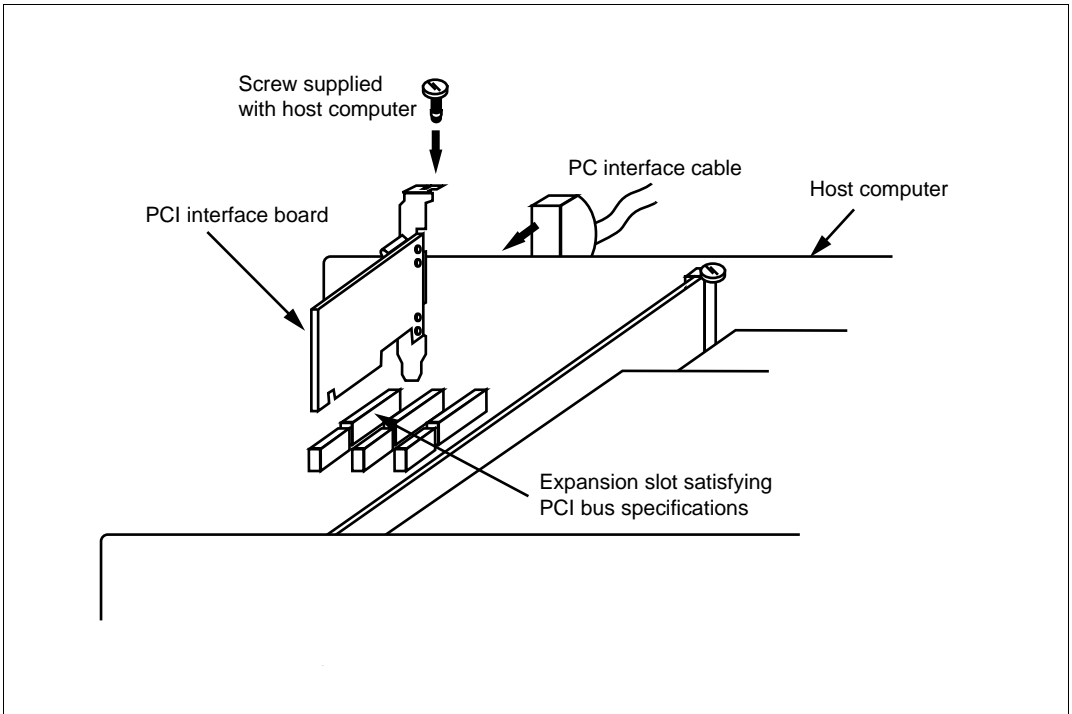

Figure 2 Installing PCI Interface Board

3.2 Connecting PCI Interface Board to E6000 Emulator

WARNING

Always switch OFF the emulator product, user and host computer before connecting or disconnecting the PC interface cable. Failure to do so will result in a FIRE HAZARD and will damage the user system, host computer, and emulator product or will result in PERSONAL INJURY.

To use the E6000 emulator, connect the PCI interface board to the E6000 emulator station via the supplied PC interface cable, as shown in figure 2. Connect the PC interface cable connector with a ferrite core to the E6000 emulator.

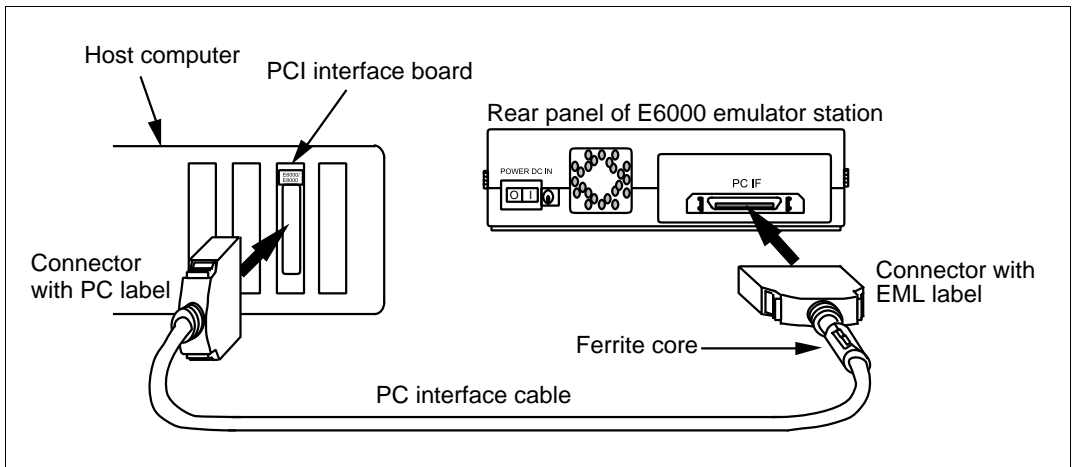

Figure 3 Connecting PCI Interface Board to E6000 Emulator

3.3 Connecting PCI Interface Board to E8000 Emulator

WARNING

Always switch OFF the emulator product, user system, and host computer before connecting or disconnecting the PC interface cable. Failure to do so will result a FIRE HAZARD and will damage the user system, host computer, and emulator product or will result in PERSONAL INJURY.

To use the E8000 emulator, connect the PCI interface board to the E8000 emulator station via the supplied PC interface cable, as shown in figure 3. Connect the PC interface cable connector with a ferrite core to the E8000 emulator.

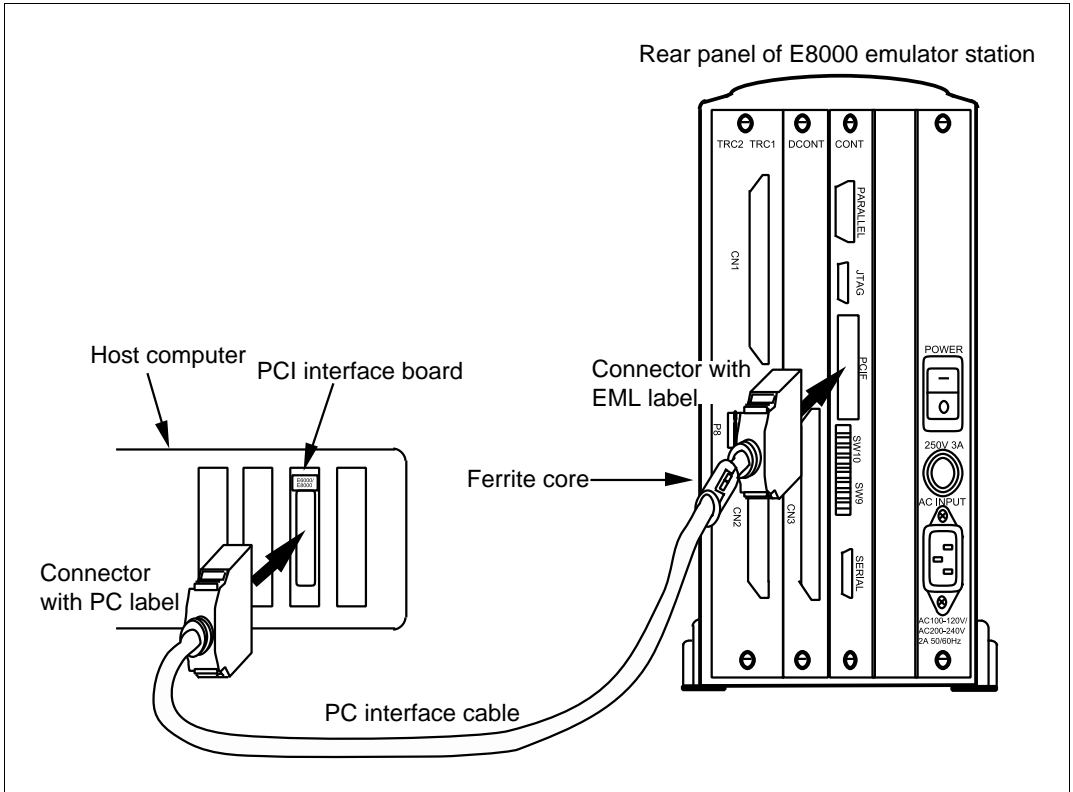

Figure 4 Connecting PCI Interface Board to E8000 Emulator

Section 4 Start Up

Start up the host computer and the emulator using the following procedure. Here, the E6000 emulator is used for an example; the E8000 emulator can also be started using the same procedure.

1. Install the Hitachi debugging interface (HDI) as the emulator control software in the host computer. Insert the HDI installation disk into the floppy disk drive of the host computer, and execute Setup.exe to install the HDI. When the Select Driver Type dialog box is displayed during installation, select PCI bus board. For details, refer to the E6000 Emulator User's Manual.
2. After the HDI installation has been completed, remove the installation disk from the host computer, and turn off the host computer.
3. Check that the host computer and emulator are turned off. Insert the PCI interface board into the host computer, and connect the emulator to the PCI interface board through the interface cable (refer to section 3, Preparation before Use).
4. Turn on the emulator and initiate the HDI.