

# Frequency Synthesizer

DSN-2520A-219+

50Ω 1120 to 2520 MHz

## The Big Deal

- Low phase noise and spurious
- Robust design and construction
- Fast settling time
- Wide bandwidth

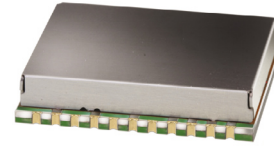

CASE STYLE: KL1294

## Product Overview

The DSN-2520A-219+ is a Frequency Synthesizer, designed to operate from 1120 to 2520 MHz for wireless sensor application. The DSN-2520A-219+ is packaged in a metal case (size of 1.250" x 1.000" x 0.232") to shield against unwanted signals and noise.

## Key Features

Feature	Advantages
Low phase noise and spurious: <ul style="list-style-type: none"><li>• Phase Noise: -97 dBc/Hz typ. @ 10 kHz offset</li><li>• Comparison Spurious: -70 dBc typ.</li><li>• Reference Spurious: -79 dBc typ.</li></ul>	Low phase noise and spurious improve system EVM (Error Vector Magnitude).
Robust design and construction	To enhance the robustness of DSN-2520A-219+, each internal component is secured to the substrate with chip bonder, thereby eliminating the risk of tombstoning during subsequent solder reflow operations by the customer.
Fast settling time. 0.5mSec typical	Settling time, 0.5mSec typical can be used for settling applications such as jammers etc.



IF/RF MICROWAVE COMPONENTS • ISO 9001 ISO 14001 AS9100 CERTIFIED RoHS compliant

P.O. Box 350166, Brooklyn, New York 11235-0003 (718) 934-4500 Fax (718) 332-4661



The Design Engineers Search Engine finds the model you need, Instantly • For detailed performance specs & shopping online see



Notes: 1. Performance and quality attributes and conditions not expressly stated in this specification sheet are intended to be excluded and do not form a part of this specification sheet. 2. Electrical specifications and performance data contained herein are based on Mini-Circuit's applicable established test performance criteria and measurement instructions. 3. The parts covered by this specification sheet are subject to Mini-Circuits standard limited warranty and terms and conditions (collectively, "Standard Terms"); Purchasers of this part are entitled to the rights and benefits contained therein. For a full statement of the Standard Terms and the exclusive rights and remedies thereunder, please visit Mini-Circuits' website at [www.minicircuits.com/MCLStore/terms.jsp](http://www.minicircuits.com/MCLStore/terms.jsp).

# Frequency Synthesizer

DSN-2520A-219+

50Ω 1120 to 2520 MHz

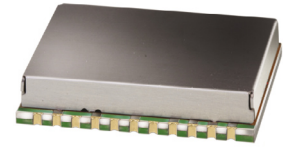

CASE STYLE: KL1294  
PRICE: \$54.95 ea. QTY (1-9)

## Features

- Integrated VCO + PLL
- Low phase noise and spurious
- Robust design and construction
- Operating voltage (VCC VCO=+10V, VCC PLL=+22V)
- Fast settling time
- Wide bandwidth

+ RoHS compliant in accordance with EU Directive (2002/95/EC)

The +Suffix has been added in order to identify RoHS Compliance. See our web site for RoHS Compliance methodologies and qualifications.

## Applications

- Wireless sensor

## General Description

The DSN-2520A-219+ is a Frequency Synthesizer, designed to operate from 1120 to 2520 MHz for wireless sensor application. The DSN-2520A-219+ is packaged in a metal case (size of 1.250" x 1.000" x 0.232") to shield against unwanted signals and noise. To enhance the robustness of DSN-2520A-219+, each internal component is secured to the substrate with chip bonder, thereby eliminating the risk of tombstoning during subsequent solder reflow operations by the customer.

## Simplified Schematic

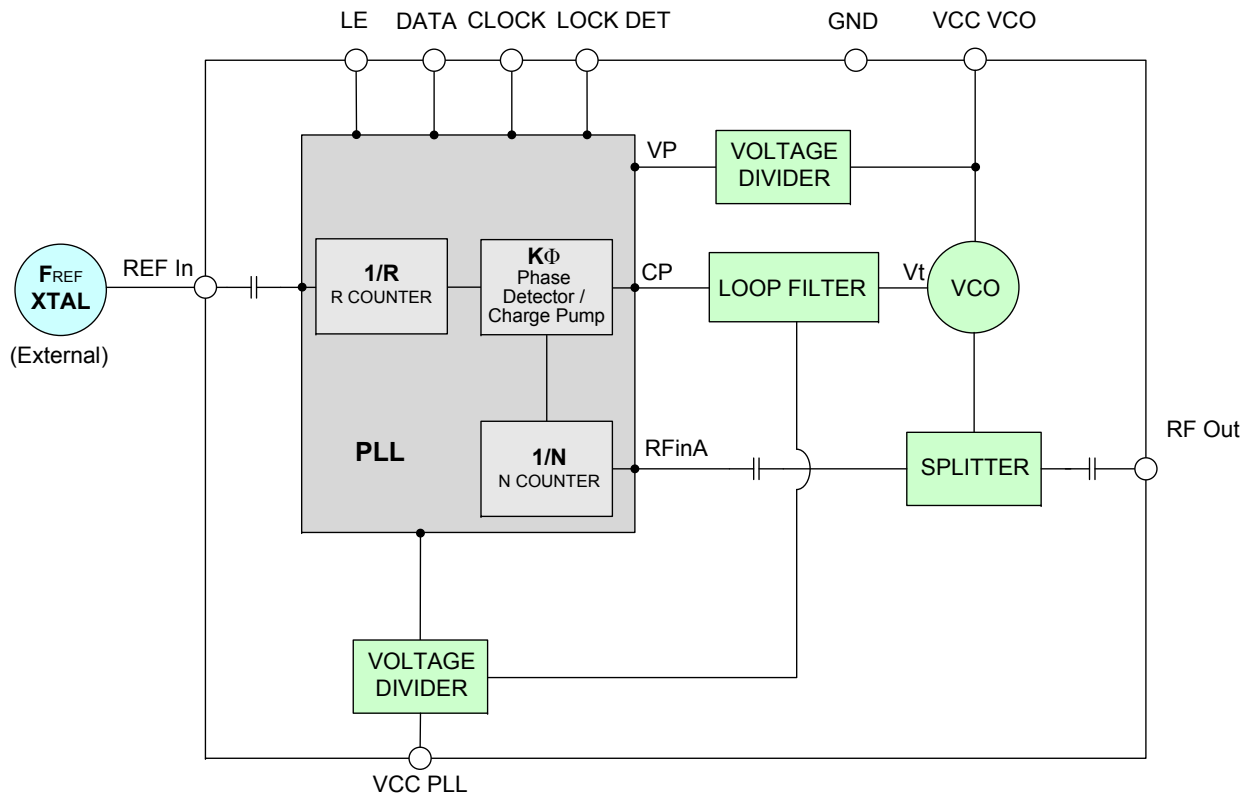

IF/RF MICROWAVE COMPONENTS • ISO 9001 ISO 14001 AS9100 CERTIFIED RoHS compliant  
P.O. Box 350166, Brooklyn, New York 11235-0003 (718) 934-4500 Fax (718) 332-4661



The Design Engineers Search Engine finds the model you need, Instantly • For detailed performance specs & shopping online see



Notes: 1. Performance and quality attributes and conditions not expressly stated in this specification sheet are intended to be excluded and do not form a part of this specification sheet. 2. Electrical specifications and performance data contained herein are based on Mini-Circuit's applicable established test performance criteria and measurement instructions. 3. The parts covered by this specification sheet are subject to Mini-Circuits standard limited warranty and terms and conditions (collectively, "Standard Terms"); Purchasers of this part are entitled to the rights and benefits contained therein. For a full statement of the Standard Terms and the exclusive rights and remedies thereunder, please visit Mini-Circuits' website at [www.minicircuits.com/MCLStore/terms.jsp](http://www.minicircuits.com/MCLStore/terms.jsp).

**Electrical Specifications** (over operating temperature -40°C to +85°C)

Parameters	Test Conditions	Min.	Typ.	Max.	Units	
Frequency Range	-	1120	-	2520	MHz	
Step Size	-	-	2.5	-	MHz	
Settling Time	Within ± 1 deg	-	0.03	-	mSec	
Output Power	-	+3.5	+6.5	+9.5	dBm	
SSB Phase Noise	@ 100 Hz offset	-	-84	-	dBc/Hz	
	@ 1 kHz offset	-	-94	-89		
	@ 10 kHz offset	-	-95	-90		
	@ 100 kHz offset	-	-92	-87		
	@ 1 MHz offset	-	-119	-114		
Integrated SSB Phase Noise	@ 100Hz - 1MHz	-	-40	-	dBc	
Reference Spurious Suppression	Ref. Freq. 20 MHz	-	-75	-60	dBc	
Comparison Spurious Suppression	Step Size 2.5 MHz	-	-70	-55		
Non - Harmonic Spurious Suppression	-	-	-90	-		
Harmonic Suppression	-	-	-25	-10		
VCO Supply Voltage	+10.00	+9.75	+10.00	+10.25		V
PLL Supply Voltage	+22.00	+21.75	+22.00	+22.25		
VCO Supply Current	-	-	74	80	mA	
PLL Supply Current	-	-	18	24		
Reference Input (External)	Frequency	20 (square wave)	-	20	-	MHz
	Amplitude	1	-	1	-	V <sub>R.P.</sub>
	Input impedance	-	-	100	-	KΩ
	Phase Noise @ 1 kHz offset	-	-	-145	-	dBc/Hz
RF Output port Impedance	-	-	50	-	Ω	
Input Logic Level	Input high voltage	-	2.65	-	-	V
	Input low voltage	-	-	-	0.65	V
Digital Lock Detect	Locked	-	2.15	-	2.70	V
	Unlocked	-	-	-	0.4	V
Frequency Synthesizer PLL	-	ADF4106				
PLL Programming	-	3-wire serial 3.3V CMOS				
Register Map @ 2520 MHz	F_Register *	-	(MSB) 010XYZ11100000000010011 (LSB)			
	N_Register	-	(MSB) 00100000011111100000001 (LSB)			
	R_Register	-	(MSB) 000100000000000010000 (LSB)			

**\* Refer to Charge Pump Settings**

FREQ.LOCK [MHz]	Charge Pump Settings		
	X	Y	Z
1120	0	0	0
1122.5 - 1400	0	1	0
1402.5 - 2100	0	1	1
2102.5 - 2240	1	0	0
2242.5 - 2360	1	0	1
2362.5 - 2460	1	1	0
2462.5 - 2520	1	1	1

**Absolute Maximum Ratings**

Parameters	Ratings
VCO Supply Voltage	11V
PLL Supply Voltage	23V
VCO Supply Voltage to PLL Supply Voltage	N.A
Reference Frequency Voltage	-0.3Vmin, +3.6Vmax
Data, Clock, LE Levels	-0.3Vmin, +3.6Vmax
Operating Temperature	-40°C to +85°C
Storage Temperature	-55°C to +100°C

Permanent damage may occur if any of these limits are exceeded



**The Design Engineers Search Engine finds the model you need, Instantly** • For detailed performance specs & shopping online see [minicircuits.com](http://minicircuits.com)

Notes: 1. Performance and quality attributes and conditions not expressly stated in this specification sheet are intended to be excluded and do not form a part of this specification sheet. 2. Electrical specifications and performance data contained herein are based on Mini-Circuit's applicable established test performance criteria and measurement instructions. 3. The parts covered by this specification sheet are subject to Mini-Circuits standard limited warranty and terms and conditions (collectively, "Standard Terms"); Purchasers of this part are entitled to the rights and benefits contained therein. For a full statement of the Standard Terms and the exclusive rights and remedies thereunder, please visit Mini-Circuits' website at [www.minicircuits.com/MCLStore/terms.jsp](http://www.minicircuits.com/MCLStore/terms.jsp).

Typical Performance Data

FREQUENCY (MHz)	POWER OUTPUT (dBm)			VCO CURRENT (mA)			PLL CURENT (mA)		
	-45°C	+25°C	+85°C	-45°C	+25°C	+85°C	-45°C	+25°C	+85°C
	1120	6.38	6.19	5.87	73.66	73.86	74.06	17.69	18.77
1225	6.48	6.20	5.94	74.20	74.32	74.43	17.82	18.94	20.65
1375	6.73	6.52	6.32	74.77	74.76	74.75	17.85	18.98	20.70
1525	7.02	6.84	6.64	75.01	74.95	74.79	17.87	19.03	20.75
1675	7.21	6.99	6.79	75.05	75.04	74.86	18.02	19.19	20.92
1825	7.20	7.01	6.78	74.97	75.05	74.91	18.03	19.22	20.96
1975	7.25	7.00	6.73	74.57	74.79	74.76	18.06	19.25	21.00
2125	7.22	7.03	6.69	74.15	74.46	74.54	18.08	19.28	21.04
2275	6.81	6.74	6.33	73.60	74.01	74.20	18.23	19.45	21.21
2425	6.53	6.27	5.85	73.10	73.62	73.93	18.25	19.48	21.25
2520	6.55	5.96	5.39	72.91	73.43	73.76	18.18	19.42	21.19

FREQUENCY (MHz)	HARMONICS (dBc)					
	F2			F3		
	-45°C	+25°C	+85°C	-45°C	+25°C	+85°C
1120	-22.21	-15.04	-17.15	-17.37	-16.75	-17.33
1225	-14.78	-16.39	-17.74	-20.60	-20.30	-20.79
1375	-19.08	-19.55	-19.98	-29.82	-29.31	-30.02
1525	-23.60	-22.55	-21.95	-33.41	-32.78	-33.87
1675	-25.41	-23.74	-22.76	-28.51	-27.61	-28.36
1825	-29.07	-27.19	-26.04	-27.41	-27.03	-28.09
1975	-30.67	-29.16	-28.61	-24.98	-24.47	-25.25
2125	-35.57	-35.27	-35.49	-22.49	-21.19	-21.99
2275	-41.39	-49.82	-57.24	-20.39	-19.63	-20.85
2425	-40.55	-36.94	-34.71	-19.22	-19.53	-21.16
2520	-35.61	-32.37	-31.07	-18.88	-18.23	-19.40



IF/RF MICROWAVE COMPONENTS • ISO 9001 ISO 14001 AS9100 CERTIFIED RoHS compliant  
 P.O. Box 350166, Brooklyn, New York 11235-0003 (718) 934-4500 Fax (718) 332-4661



The Design Engineers Search Engine finds the model you need, Instantly • For detailed performance specs & shopping online see



Notes: 1. Performance and quality attributes and conditions not expressly stated in this specification sheet are intended to be excluded and do not form a part of this specification sheet. 2. Electrical specifications and performance data contained herein are based on Mini-Circuit's applicable established test performance criteria and measurement instructions. 3. The parts covered by this specification sheet are subject to Mini-Circuits standard limited warranty and terms and conditions (collectively, "Standard Terms"); Purchasers of this part are entitled to the rights and benefits contained therein. For a full statement of the Standard Terms and the exclusive rights and remedies thereunder, please visit Mini-Circuits' website at [www.minicircuits.com/MCLStore/terms.jsp](http://www.minicircuits.com/MCLStore/terms.jsp).

FREQUENCY (MHz)	PHASE NOISE (dBc/Hz) @OFFSETS				
	+25°C				
	100Hz	1kHz	10kHz	100kHz	1MHz
1120	-90.77	-100.03	-99.22	-94.77	-119.64
1225	-91.35	-99.88	-100.58	-96.45	-121.11
1375	-90.76	-99.76	-100.17	-96.04	-121.58
1525	-91.53	-98.21	-99.38	-96.90	-119.53
1675	-85.55	-96.75	-98.72	-95.94	-118.99
1825	-89.02	-97.77	-97.09	-94.45	-119.22
1975	-86.00	-94.35	-96.41	-92.79	-119.57
2125	-87.12	-95.30	-94.73	-92.07	-119.07
2275	-86.20	-94.38	-93.80	-91.36	-119.22
2425	-88.80	-94.90	-95.68	-92.58	-119.79
2520	-84.95	-95.17	-94.75	-91.98	-120.82

FREQUENCY (MHz)	PHASE NOISE (dBc/Hz) @OFFSETS				
	-45°C				
	100Hz	1kHz	10kHz	100kHz	1MHz
1120	-92.21	-99.15	-99.36	-95.04	-119.05
1225	-91.98	-99.12	-100.06	-96.63	-120.67
1375	-88.73	-98.57	-99.69	-95.85	-121.63
1525	-89.92	-98.20	-99.40	-96.87	-119.67
1675	-88.83	-98.00	-98.84	-96.21	-119.18
1825	-87.40	-96.51	-97.69	-94.51	-119.24
1975	-85.62	-96.53	-96.88	-93.59	-119.30
2125	-85.75	-94.70	-95.34	-92.32	-118.81
2275	-86.94	-94.27	-94.16	-90.89	-119.23
2425	-86.03	-94.74	-95.11	-92.18	-119.98
2520	-86.27	-94.86	-94.87	-91.91	-120.59

FREQUENCY (MHz)	PHASE NOISE (dBc/Hz) @OFFSETS				
	+85°C				
	100Hz	1kHz	10kHz	100kHz	1MHz
1120	-93.40	-102.34	-102.03	-97.18	-121.70
1225	-91.16	-100.59	-101.08	-97.25	-121.97
1375	-89.67	-99.07	-99.87	-96.67	-120.68
1525	-89.16	-99.44	-99.36	-97.16	-118.65
1675	-89.23	-98.49	-98.31	-95.63	-118.18
1825	-88.32	-96.34	-96.63	-94.34	-118.30
1975	-88.27	-94.66	-95.75	-92.17	-118.79
2125	-88.42	-94.23	-95.60	-92.36	-118.85
2275	-86.89	-95.19	-95.46	-92.65	-119.19
2425	-88.76	-94.41	-95.57	-93.22	-119.70
2520	-84.91	-94.41	-94.16	-91.54	-120.24



IF/RF MICROWAVE COMPONENTS • ISO 9001 ISO 14001 AS9100 CERTIFIED RoHS compliant  
 P.O. Box 350166, Brooklyn, New York 11235-0003 (718) 934-4500 Fax (718) 332-4661



The Design Engineers Search Engine finds the model you need, Instantly • For detailed performance specs & shopping online see



Notes: 1. Performance and quality attributes and conditions not expressly stated in this specification sheet are intended to be excluded and do not form a part of this specification sheet. 2. Electrical specifications and performance data contained herein are based on Mini-Circuit's applicable established test performance criteria and measurement instructions. 3. The parts covered by this specification sheet are subject to Mini-Circuits standard limited warranty and terms and conditions (collectively, "Standard Terms"); Purchasers of this part are entitled to the rights and benefits contained therein. For a full statement of the Standard Terms and the exclusive rights and remedies thereunder, please visit Mini-Circuits' website at [www.minicircuits.com/MCLStore/terms.jsp](http://www.minicircuits.com/MCLStore/terms.jsp).

COMPARISON SPURIOUS ORDER	COMPARISON SPURIOUS @Fcarrier 1120MHz+(n*Fcomparison) (dBc) note 1			COMPARISON SPURIOUS @Fcarrier 1820MHz+(n*Fcomparison) (dBc) note 1			COMPARISON SPURIOUS @Fcarrier 2520MHz+(n*Fcomparison) (dBc) note 1		
	n	-45°C	+25°C	+85°C	-45°C	+25°C	+85°C	-45°C	+25°C
-5	-100.56	-97.62	-94.59	-84.04	-85.04	-86.17	-89.75	-89.20	-91.42
-4	-93.24	-97.46	-92.81	-86.01	-84.06	-85.07	-85.32	-87.82	-90.28
-3	-94.50	-93.93	-90.53	-80.56	-81.86	-83.24	-85.75	-85.94	-88.56
-2	-90.14	-90.43	-87.40	-76.87	-78.77	-80.48	-82.21	-83.01	-85.71
-1	-79.16	-83.05	-82.24	-69.76	-72.76	-75.68	-74.18	-76.15	-79.64
0 <sup>note 2</sup>	-	-	-	-	-	-	-	-	-
+1	-79.26	-82.89	-82.99	-71.27	-75.72	-79.45	-79.36	-82.46	-84.71
+2	-87.71	-88.12	-85.67	-76.72	-78.74	-80.33	-81.29	-82.81	-84.93
+3	-90.72	-90.54	-88.43	-79.47	-81.25	-82.40	-83.12	-84.74	-86.35
+4	-90.64	-92.74	-90.25	-84.73	-83.29	-84.08	-82.90	-86.21	-87.59
+5	-93.75	-93.24	-91.50	-82.58	-84.13	-84.97	-85.99	-87.23	-88.38

Note 1: Comparison frequency 2.5 MHz

Note 2: All spurs are referenced to carrier signal (n=0).

REFERENCE SPURIOUS ORDER	REFERENCE SPURIOUS @Fcarrier 1120MHz+(n*Freference) (dBc) note 3			REFERENCE SPURIOUS @Fcarrier 1820MHz+(n*Freference) (dBc) note 3			REFERENCE SPURIOUS @Fcarrier 2520MHz+(n*Freference) (dBc) note 3		
	n	-45°C	+25°C	+85°C	-45°C	+25°C	+85°C	-45°C	+25°C
-5	-124.61	-110.80	-119.92	-112.12	-114.01	-112.65	-114.52	-108.00	-112.21
-4	-99.69	-99.49	-101.18	-107.35	-106.99	-106.84	-104.31	-102.71	-105.83
-3	-104.14	-102.38	-103.17	-94.66	-95.57	-96.08	-97.57	-98.47	-97.77
-2	-89.97	-89.97	-89.39	-79.06	-78.70	-79.79	-82.13	-84.04	-85.12
-1	-101.64	-98.58	-96.63	-84.82	-85.71	-86.70	-90.50	-88.97	-92.08
0 <sup>note 4</sup>	-	-	-	-	-	-	-	-	-
+1	-94.43	-94.22	-92.80	-83.41	-84.69	-85.35	-86.88	-88.39	-88.41
+2	-87.30	-88.34	-88.49	-78.93	-79.56	-80.61	-83.96	-83.93	-84.80
+3	-103.88	-108.95	-111.21	-103.29	-100.83	-103.09	-110.32	-106.46	-103.94
+4	-99.44	-99.18	-103.24	-109.04	-107.71	-109.69	-110.36	-105.14	-110.05
+5	-115.21	-115.52	-112.19	-114.89	-114.69	-111.56	-131.09	-115.20	-114.01

Note 3: Reference frequency 20 MHz

Note 4: All spurs are referenced to carrier signal (n=0).



IF/RF MICROWAVE COMPONENTS • ISO 9001 ISO 14001 AS9100 CERTIFIED RoHS compliant  
 P.O. Box 350166, Brooklyn, New York 11235-0003 (718) 934-4500 Fax (718) 332-4661



The Design Engineers Search Engine finds the model you need, Instantly • For detailed performance specs & shopping online see



Notes: 1. Performance and quality attributes and conditions not expressly stated in this specification sheet are intended to be excluded and do not form a part of this specification sheet. 2. Electrical specifications and performance data contained herein are based on Mini-Circuit's applicable established test performance criteria and measurement instructions. 3. The parts covered by this specification sheet are subject to Mini-Circuits standard limited warranty and terms and conditions (collectively, "Standard Terms"); Purchasers of this part are entitled to the rights and benefits contained therein. For a full statement of the Standard Terms and the exclusive rights and remedies thereunder, please visit Mini-Circuits' website at [www.minicircuits.com/MCLStore/terms.jsp](http://www.minicircuits.com/MCLStore/terms.jsp).

Typical Performance Curves

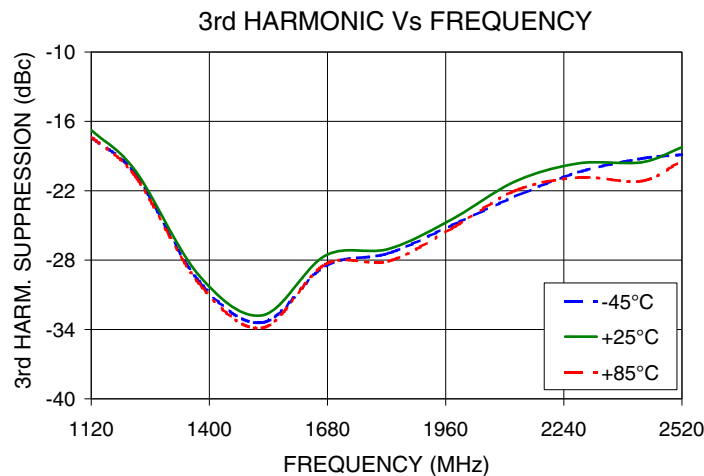
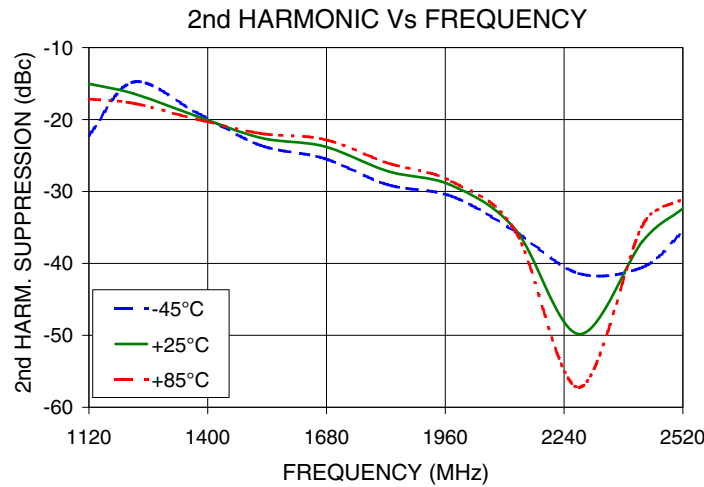
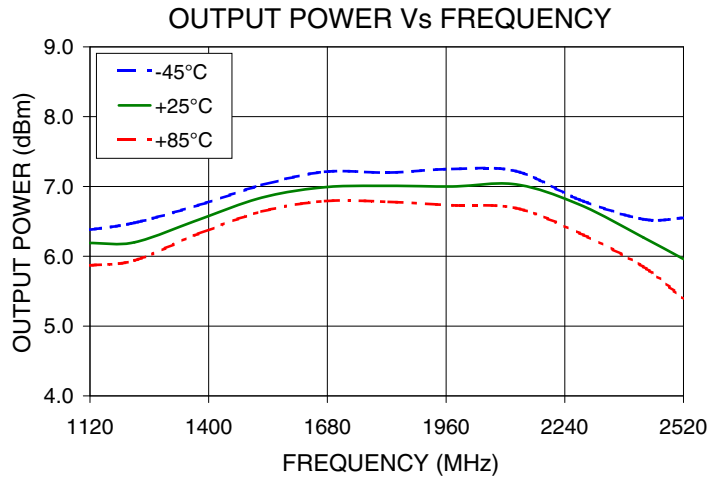

IF/RF MICROWAVE COMPONENTS • ISO 9001 ISO 14001 AS9100 CERTIFIED RoHS compliant  
 P.O. Box 350166, Brooklyn, New York 11235-0003 (718) 934-4500 Fax (718) 332-4661



The Design Engineers Search Engine finds the model you need, Instantly • For detailed performance specs & shopping online see



Notes: 1. Performance and quality attributes and conditions not expressly stated in this specification sheet are intended to be excluded and do not form a part of this specification sheet. 2. Electrical specifications and performance data contained herein are based on Mini-Circuit's applicable established test performance criteria and measurement instructions. 3. The parts covered by this specification sheet are subject to Mini-Circuits standard limited warranty and terms and conditions (collectively, "Standard Terms"); Purchasers of this part are entitled to the rights and benefits contained therein. For a full statement of the Standard Terms and the exclusive rights and remedies thereunder, please visit Mini-Circuits' website at [www.minicircuits.com/MCLStore/terms.jsp](http://www.minicircuits.com/MCLStore/terms.jsp).

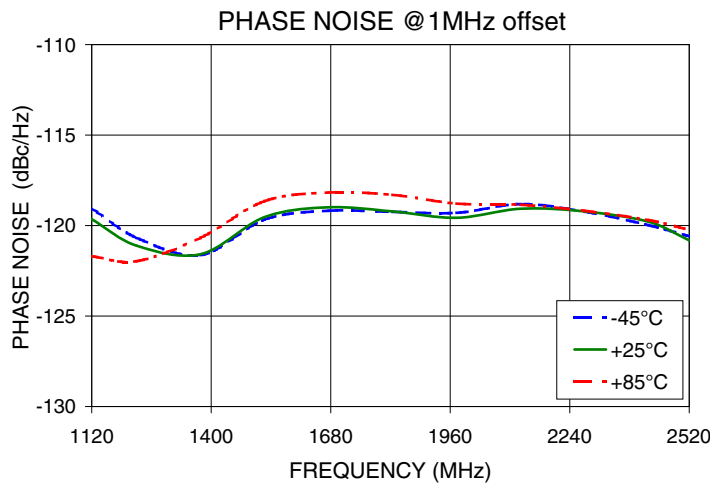
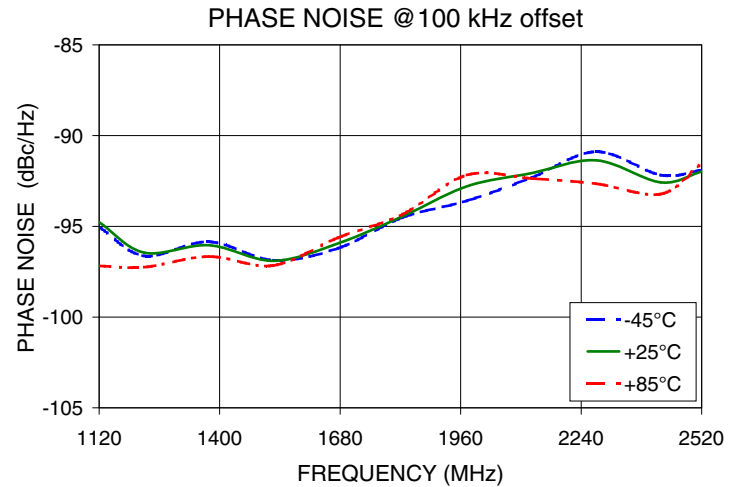
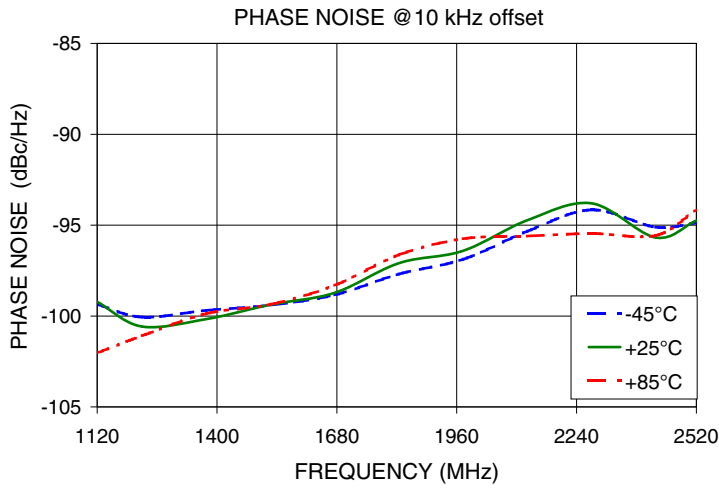
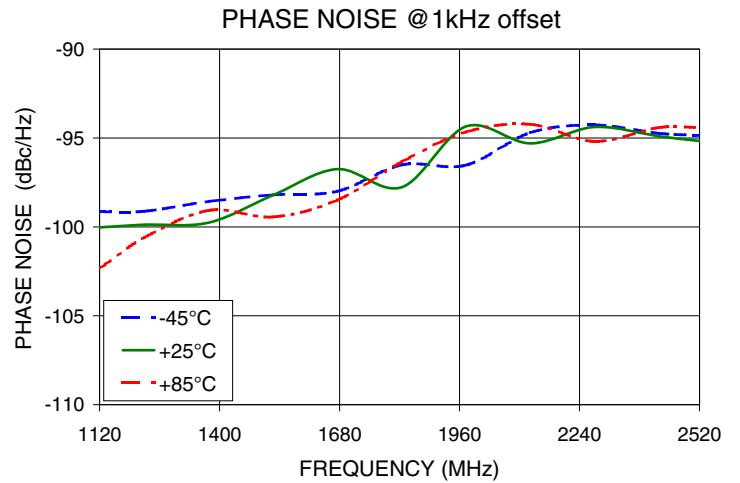
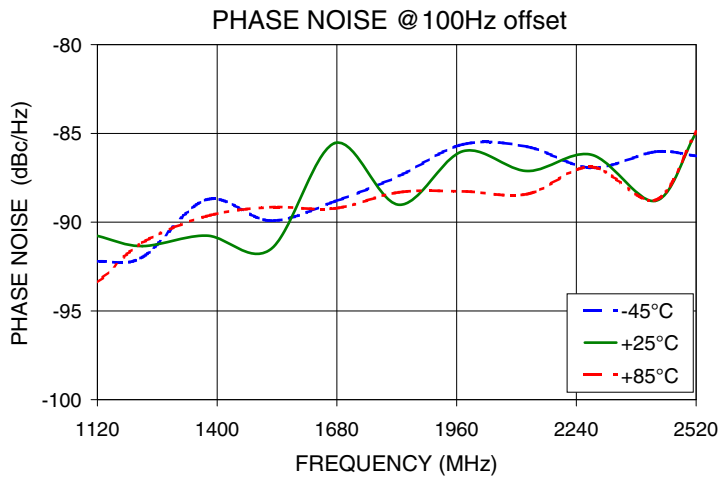

IF/RF MICROWAVE COMPONENTS • ISO 9001 ISO 14001 AS9100 CERTIFIED RoHS compliant  
 P.O. Box 350166, Brooklyn, New York 11235-0003 (718) 934-4500 Fax (718) 332-4661



The Design Engineers Search Engine finds the model you need, Instantly • For detailed performance specs & shopping online see



Notes: 1. Performance and quality attributes and conditions not expressly stated in this specification sheet are intended to be excluded and do not form a part of this specification sheet. 2. Electrical specifications and performance data contained herein are based on Mini-Circuit's applicable established test performance criteria and measurement instructions. 3. The parts covered by this specification sheet are subject to Mini-Circuits standard limited warranty and terms and conditions (collectively, "Standard Terms"); Purchasers of this part are entitled to the rights and benefits contained therein. For a full statement of the Standard Terms and the exclusive rights and remedies thereunder, please visit Mini-Circuits' website at [www.minicircuits.com/MCLStore/terms.jsp](http://www.minicircuits.com/MCLStore/terms.jsp).



COMPARISON SPURIOUS  
Vs FREQ. OFFSET @ Fcar = 1120MHz

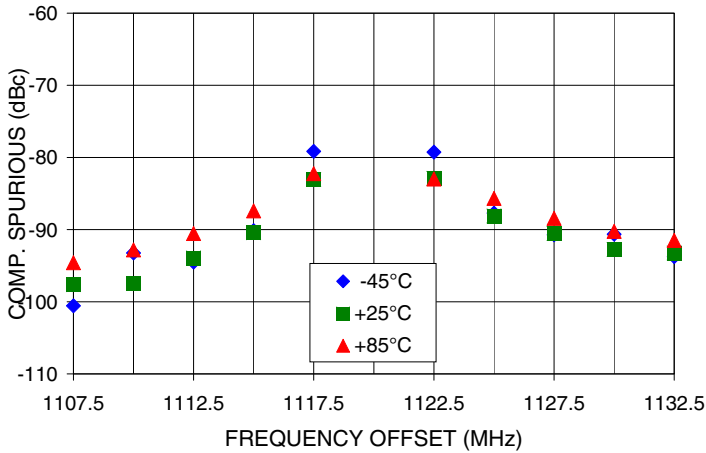

REFERENCE SPURIOUS  
Vs FREQ. OFFSET @ Fcar = 1120MHz

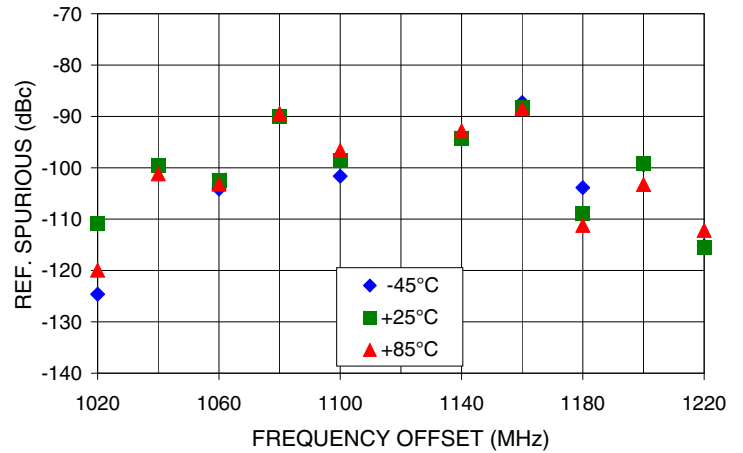

COMPARISON SPURIOUS  
Vs FREQ. OFFSET @ Fcar = 1820MHz

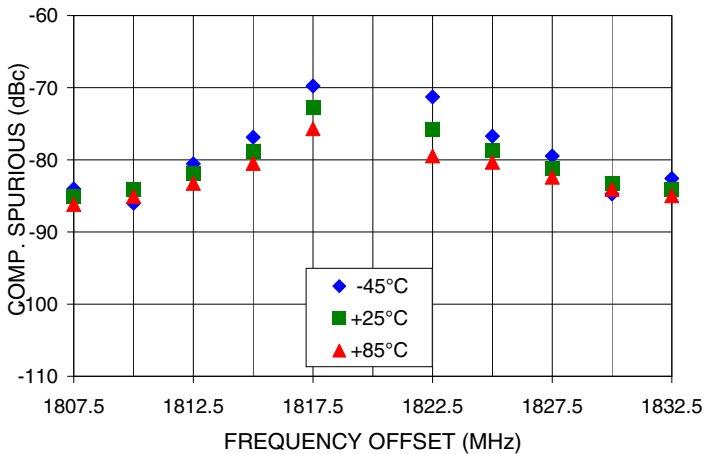

REFERENCE SPURIOUS  
Vs FREQ. OFFSET @ Fcar = 1820MHz

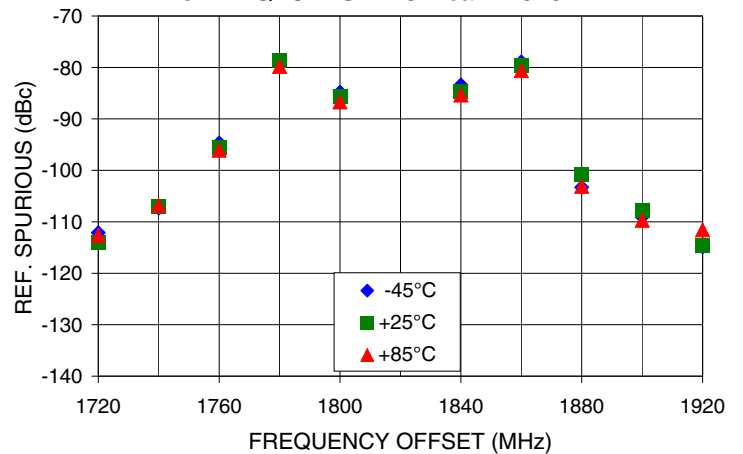

COMPARISON SPURIOUS  
Vs FREQ. OFFSET @ Fcar = 2520MHz

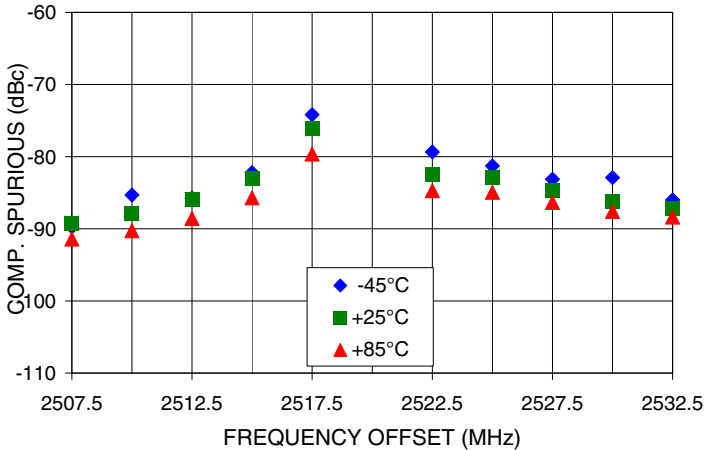

REFERENCE SPURIOUS  
Vs FREQ. OFFSET @ Fcar = 2520MHz

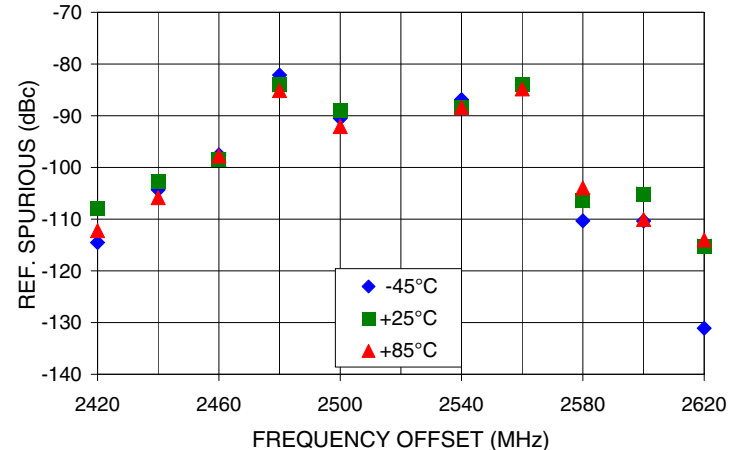

IF/RF MICROWAVE COMPONENTS • ISO 9001 ISO 14001 AS9100 CERTIFIED RoHS compliant  
P.O. Box 350166, Brooklyn, New York 11235-0003 (718) 934-4500 Fax (718) 332-4661



The Design Engineers Search Engine finds the model you need, Instantly • For detailed performance specs & shopping online see



Notes: 1. Performance and quality attributes and conditions not expressly stated in this specification sheet are intended to be excluded and do not form a part of this specification sheet. 2. Electrical specifications and performance data contained herein are based on Mini-Circuit's applicable established test performance criteria and measurement instructions. 3. The parts covered by this specification sheet are subject to Mini-Circuits standard limited warranty and terms and conditions (collectively, "Standard Terms"); Purchasers of this part are entitled to the rights and benefits contained therein. For a full statement of the Standard Terms and the exclusive rights and remedies thereunder, please visit Mini-Circuits' website at [www.minicircuits.com/MCLStore/terms.jsp](http://www.minicircuits.com/MCLStore/terms.jsp).

Pin Configuration

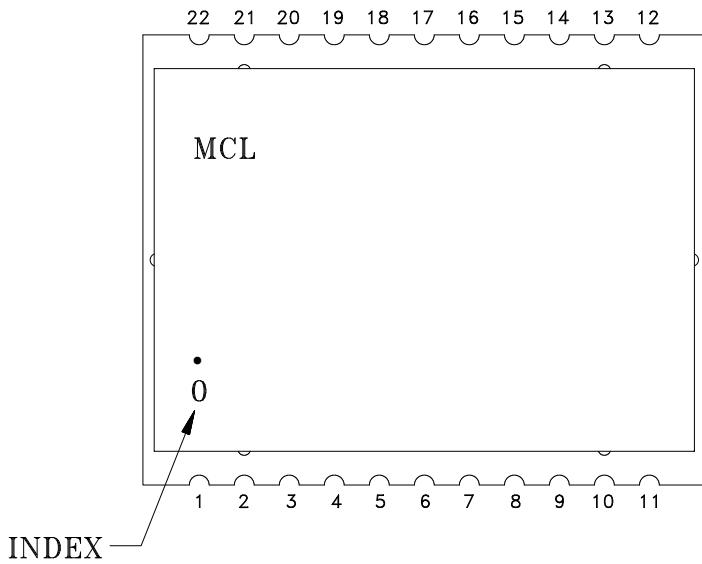

Pin Connection

Pin Number	Function	Pin Number	Function
1	GND	12	LE
2	GND	13	GND
3	GND	14	REF IN
4	GND	15	GND
5	RF OUT	16	VCC VCO
6	GND	17	GND
7	LOCK DET	18	VCC PLL
8	GND	19	GND
9	DATA	20	GND
10	GND	21	GND
11	CLOCK	22	GND

Recommended Application Circuit

Note: REF IN and RF OUT ports are internally AC coupled.

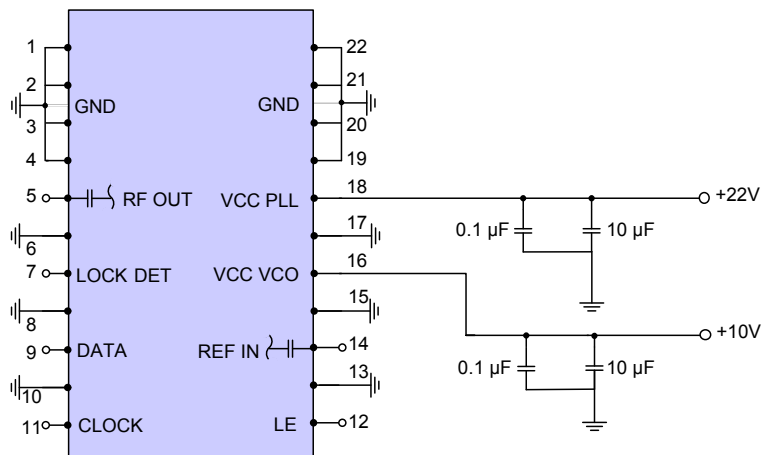

IF/RF MICROWAVE COMPONENTS • ISO 9001 ISO 14001 AS9100 CERTIFIED RoHS compliant  
 P.O. Box 350166, Brooklyn, New York 11235-0003 (718) 934-4500 Fax (718) 332-4661



The Design Engineers Search Engine finds the model you need, Instantly • For detailed performance specs & shopping online see



Notes: 1. Performance and quality attributes and conditions not expressly stated in this specification sheet are intended to be excluded and do not form a part of this specification sheet. 2. Electrical specifications and performance data contained herein are based on Mini-Circuit's applicable established test performance criteria and measurement instructions. 3. The parts covered by this specification sheet are subject to Mini-Circuits standard limited warranty and terms and conditions (collectively, "Standard Terms"); Purchasers of this part are entitled to the rights and benefits contained therein. For a full statement of the Standard Terms and the exclusive rights and remedies thereunder, please visit Mini-Circuits' website at [www.minicircuits.com/MCLStore/terms.jsp](http://www.minicircuits.com/MCLStore/terms.jsp).

## Device Marking

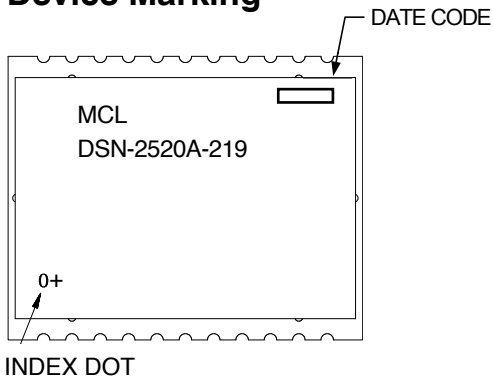

### Additional Detailed Technical Information

Additional information is available on our web site. To access this information enter the model number on our web site home page.

**Case Style:** KL1294

**Tape & Reel:** TR-F97

**Suggested Layout for PCB Design:** PL-318

**Evaluation Board:** TB-553+

**Environment Ratings:** ENV03T2



IF/RF MICROWAVE COMPONENTS • ISO 9001 ISO 14001 AS9100 CERTIFIED RoHS compliant  
P.O. Box 350166, Brooklyn, New York 11235-0003 (718) 934-4500 Fax (718) 332-4661



The Design Engineers Search Engine finds the model you need, Instantly • For detailed performance specs & shopping online see



Notes: 1. Performance and quality attributes and conditions not expressly stated in this specification sheet are intended to be excluded and do not form a part of this specification sheet. 2. Electrical specifications and performance data contained herein are based on Mini-Circuit's applicable established test performance criteria and measurement instructions. 3. The parts covered by this specification sheet are subject to Mini-Circuits standard limited warranty and terms and conditions (collectively, "Standard Terms"); Purchasers of this part are entitled to the rights and benefits contained therein. For a full statement of the Standard Terms and the exclusive rights and remedies thereunder, please visit Mini-Circuits' website at [www.minicircuits.com/MCLStore/terms.jsp](http://www.minicircuits.com/MCLStore/terms.jsp).