

NON-ISOLATED DC/DC CONVERTERS

4.5 Vdc - 14 Vdc Input, 0.59 Vdc - 5.5 Vdc /3 A Outputs



December 3, 2010

Bel Power, Inc., a subsidiary of Bel Fuse, Inc.

SLIN-03E1Ax

RoHS Compliant

Rev.F

Features

- Wide Input Voltage Range
- Fixed Switching Frequency
- Power Good Signal
- Remote Sense
- Remote On/Off
- Tunable Loop™ (a registered trademark of Lineage Power Systems) to Optimize Dynamic output voltage response
- Flexible output voltage sequencing
- Class 1, Category 2, Non-Isolated DC/DC Converter (refer to IPC-9592)
- Compliant to RoHS EU Directive 2002/95/EC
- Compatible in a Pb-free or SnPb reflow environment
- UL* 60950-1 Recognized, CSA† C22.2 No. 60950-1-03 Certified
- VDE‡ 0805:2001-12 (EN60950-1) Licensed
- Ability to Sink and Source Current
- Cost Efficient Open Frame Design
- Over Temperature Protection
- Output Over Current Protection



Applications

- Distributed power architectures
- Intermediate bus voltage applications
- Telecommunications equipment
- Servers and storage applications
- Networking equipment
- Industrial equipment



Description

The SLIN-03E1Ax power modules are non-isolated dc-dc converters that can deliver up to 3A of output current. These modules operate over a wide range of input voltage ($V_{IN} = 4.5Vdc-14Vdc$) and provide a precisely regulated output voltage from 0.59Vdc to 5.5Vdc, programmable via an external resistor. Features include remote On/Off, adjustable output voltage, over current and over temperature protection, and output voltage sequencing. A new feature, the Tunable Loop™, allows the user to optimize the dynamic response of the converter to match the load with reduced amount of output capacitance leading to savings on cost and PWB area.

Part Selection

Output Voltage	Input Voltage	Max. Output Current	Typical Efficiency	Model Number Active High	Model Number Active Low
0.59 Vdc - 5.5 Vdc	4.5 Vdc - 14 Vdc	3 A	91%	SLIN-03E1A0	SLIN-03E1AL

Notes: Add "G" suffix at the end of the model number to indicate Tray Packaging.

Part Number Explanation

S LIN - 03 E 1A 0
1 2 3 4 5 6

1---Surface mount
2---Series code
3---Output current (3A)

4--- Wide input voltage range (4.5-14V)
5--- Wide output voltage range (0.59-5.5V)
6--- Enable, active high, change "0" to "L" means active low

NON-ISOLATED DC/DC CONVERTERS

4.5 Vdc - 14 Vdc Input, 0.59 Vdc - 5.5 Vdc /3 A Outputs



December 3, 2010

Bel Power, Inc., a subsidiary of Bel Fuse, Inc.

Absolute Maximum Ratings

Parameter	Min	Typ	Max	Unit	Notes
Continuous Input Voltage	-0.3	-	15	V	
Sequencing Voltage	-0.3	-	V _{in}	V	
Operating Ambient Temperature	-40	-	85	°C	
Storage Temperature	-55	-	125	°C	

Note: Stresses in excess of the absolute maximum ratings can cause permanent damage to the device. These are absolute stress ratings only, functional operation of the device is not implied at these or any other conditions in excess of those given in the operations sections of the data sheet. Exposure to absolute maximum ratings for extended periods can adversely affect the device reliability.

Input Specifications

Parameter	Min	Typ	Max	Unit	Notes
Operating Input Voltage	4.5	-	14	V	
Input Current (full load)	-	-	3.5	A	V _{IN} =4.5V to 14V
Input Current (no load)					
V _o =0.6V	-	17	-	mA	V _{IN} =12V, module enabled
V _o =3.3V	-	55	-	mA	
Input Stand-by Current	-	1	-	mA	V _{IN} = 12.0Vdc, module disabled
Input Reflected Ripple Current (pk-pk)	-	43	-	mA	5Hz to 20MHz, 1μH source impedance; V _{IN} =0 to 14V, I _o = I _o max; See Test Configurations
I ² t Inrush Current Transient	-	-	1	A ² s	
Input Ripple Rejection (120Hz)	-	50	-	dB	
Turn-on Threshold	-	-	4.3	V	
Turn-off Threshold	3.3	-	-	V	
Hysteresis	0.4	-	-	V	

CAUTION: This converter is not internally fused. An input line fuse must be used in application.

This power module can be used in a wide variety of applications, ranging from simple standalone operation to an integrated part of sophisticated power architecture. To preserve maximum flexibility, internal fusing is not included; however, to achieve maximum safety and system protection, always use an input line fuse. The safety agencies require a fast-acting fuse with a maximum rating of 5A. Based on the information provided in this data sheet on inrush energy and maximum dc input current, the same type of fuse with a lower rating can be used. Refer to the fuse manufacturer's data sheet for further information.

Note: Unless otherwise indicated, specifications apply over all operating input voltage, resistive load, and temperature conditions.

NON-ISOLATED DC/DC CONVERTERS

4.5 Vdc - 14 Vdc Input, 0.59 Vdc - 5.5 Vdc / 3 A Outputs



December 3, 2010

Bel Power, Inc., a subsidiary of Bel Fuse, Inc.

Output Specifications

Parameter	Min	Typ	Max	Unit	Notes
Output Voltage Set Point	-1.5	-	+1.5	%Vo,set	with 0.5% tolerance for external resistor used to set output voltage
Output Voltage	-3.0	-	+3.0	%Vo,set	Over all operating input voltage, resistive load, and temperature conditions until end of life
Adjustment Range ¹	0.59	-	5.5	V	selected by an external resistor
Remote Sense Range	-	-	0.5	V	
Load Regulation					
Vo ≥ 2.5V	-	-	10	mV	Io=Io, min to Io, max
Vo < 2.5V	-	-	5	mV	
Line Regulation					
Vo ≥ 2.5V	-	-	0.4	%Vo,set	VIN=VIN, min to VIN, max
Vo < 2.5V	-	-	10	mV	
Temperature Regulation (-40°C to +85°C)	-	-	0.4	%Vo,set	
Ripple and Noise (pk-pk)	-	50	110	mV	Vo ≤ 3.3V, 5Hz to 20MHz BW, VIN=VIN, nom and Io=Io, min to Io, max Co = 0.1µF // 10 µF ceramic capacitors
Ripple and Noise (rms)	-	20	40	mV	
Ripple and Noise (pk-pk)	-	110	135	mV	Vo > 3.3V, 5Hz to 20MHz BW, VIN=VIN, nom and Io=Io, min to Io, max Co = 0.1µF // 10 µF ceramic capacitors
Ripple and Noise (rms)	-	35	45	mV	
Output Current Range	0	-	3	A	in either sink or source mode
Output DC Current Limit	-	200	-	%Io,max	Hiccup Mode
Output Short-Circuit Current	-	300	-	mA	Vo≤250mV, Hiccup Mode
Output Capacitance ²					
ESR ≥ 1 mΩ	0	-	47	µF	Without the Tunable Loop™ With the Tunable Loop™ With the Tunable Loop™
ESR ≥ 0.15 mΩ	0	-	1000	µF	
ESR ≥ 10 mΩ	0	-	3000	µF	
Turn-On Delay Time	-	2	-	mS	Case 1: On/Off input is enabled and then input power is applied (delay from instant at which VIN = VIN, min until Vo = 10% of Vo, set)
	-	2	-	mS	Case 2: Input power is applied for at least one second and then the On/Off input is enabled (delay from instant at which Von/Off is enabled until Vo = 10% of Vo, set)
Output voltage Rise time	-	4	-	mS	time for Vo to rise from 10% of Vo, set to 90% of Vo, set
Output voltage overshoot	-	-	3	%Vo,set	Vin=Vin, min to Vin, max, Io=Io, min to Io, max, With or without maximum external capacitance

NON-ISOLATED DC/DC CONVERTERS

4.5 Vdc - 14 Vdc Input, 0.59 Vdc - 5.5 Vdc / 3 A Outputs



December 3, 2010

Bel Power, Inc., a subsidiary of Bel Fuse, Inc.

Output Specifications (Continued)

Dynamic Load Response						
ΔV50%~100% of Max Load	Peak Deviation	-	220	-	mV	di/dt=10A/us, Vin=Vin,nom, Vo=1.8V, Ta=25°C, Co=0
	Settling Time	-	60	-	uS	
ΔV100%~50% of Max Load	Peak Deviation	-	240	-	mV	
	Settling Time	-	60	-	uS	

- Notes:**
1. Some output voltages may not be possible depending on the input voltage.
 2. External capacitors may require using the new Tunable Loop™ feature to ensure that the module is stable as well as getting the best transient response (See the Tunable Loop™ section for details).
 3. Unless otherwise indicated, specifications apply over all operating input voltage, resistive load, and temperature conditions.

General Specifications

Parameter	Min	Typ	Max	Unit	Notes
Efficiency					
Vo=0.59V	-	73.3	-	%	Vin= 12Vdc, Ta=25°C Io=Io, max, Vo= Vo,set
Vo=1.2V	-	82.9	-	%	
Vo=1.8V	-	86.5	-	%	
Vo=2.5V	-	88.9	-	%	
Vo=3.3V	-	90.6	-	%	
Vo=5.0V	-	92.6	-	%	
Switching Frequency	-	600	-	kHz	
Over Temperature Protection	-	140	-	°C	
Tracking Accuracy					
Power-Up: 2V/ms	-	-	100	mV	Vin, min to Vin, max; Io, min to Io, max, Vseq < Vo
Power-Down: 2V/ms	-	-	100	mV	
PGOOD (Power Good)					
Output Voltage Limit for PGOOD	90	-	110	%Vo,set	Signal Interface Open Drain, Vsupply ≤ 5Vdc
Pulldown resistance of PGOOD pin	-	7	50	Ω	
Weight	-	1.55	-	g	
MTBF		15,694,689		hours	Calculated Per Bell Core SR-332 (Io=0.8Io, max, Ta=40°C, Telecordia Issue 2 Method 1 Case 3)
Dimensions					
Inches (L × W × H)		0.48 x 0.48 x 0.246		-	
Millimeters (L × W × H)		12.19 x 12.19 x 6.25			

Note: Unless otherwise indicated, specifications apply over all operating input voltage, resistive load, and temperature conditions.

NON-ISOLATED DC/DC CONVERTERS

4.5 Vdc - 14 Vdc Input, 0.59 Vdc - 5.5 Vdc / 3 A Outputs



December 3, 2010

Bel Power, Inc., a subsidiary of Bel Fuse, Inc.

Efficiency Data

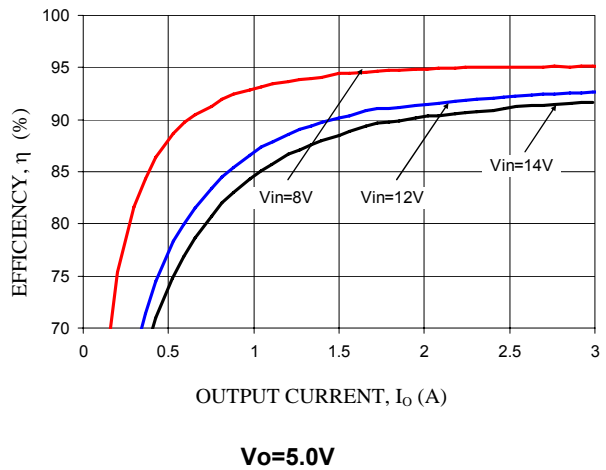
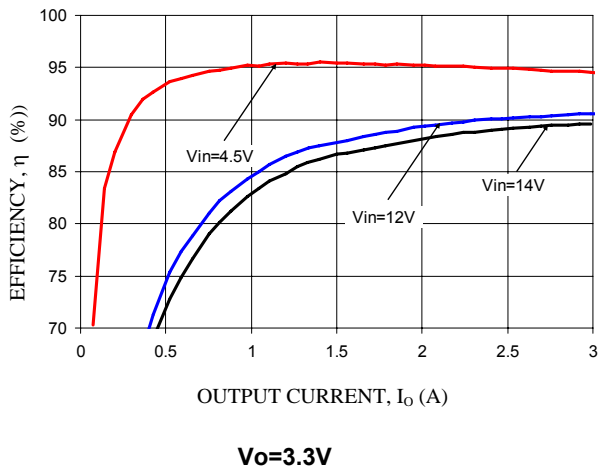
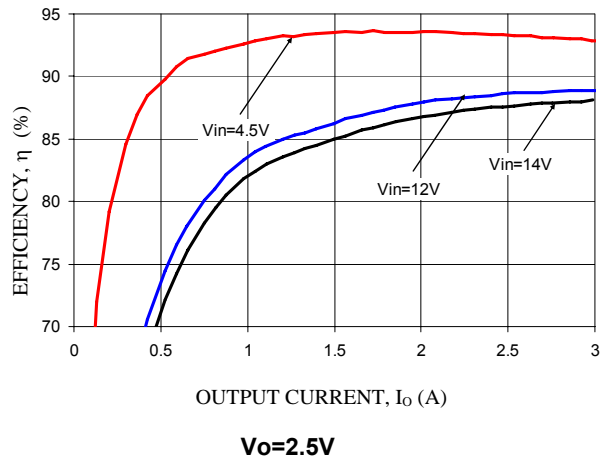
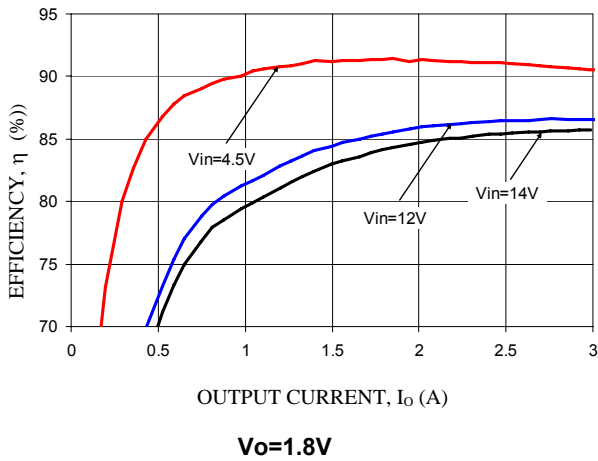
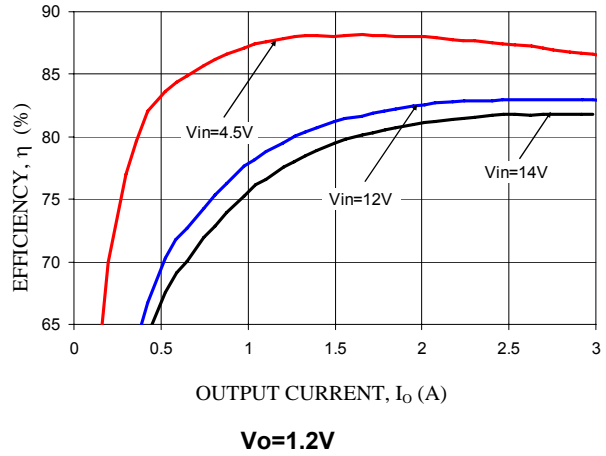
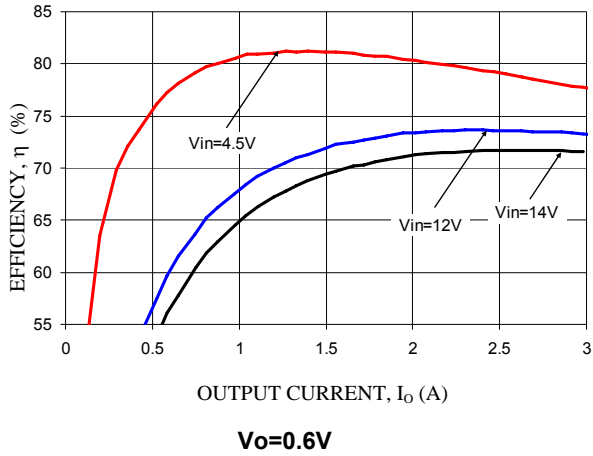

Thermal Derating Curves

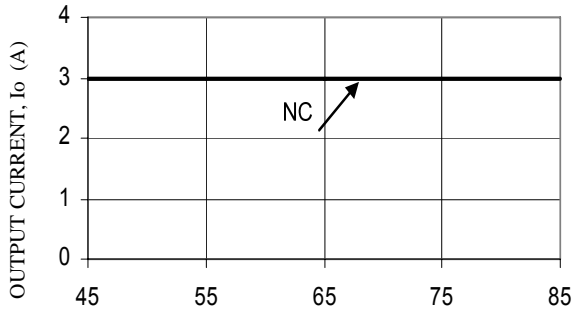

AMBIENT TEMPERATURE, T_A °C

$V_o=0.6V$

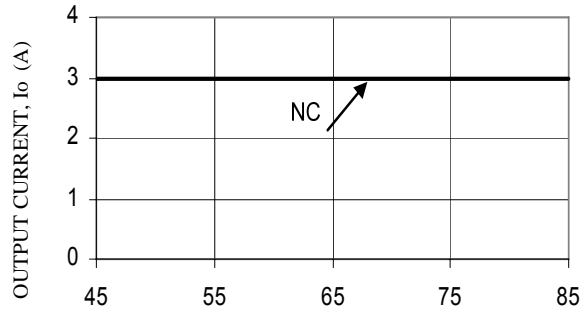

AMBIENT TEMPERATURE, T_A °C

$V_o=1.2V$

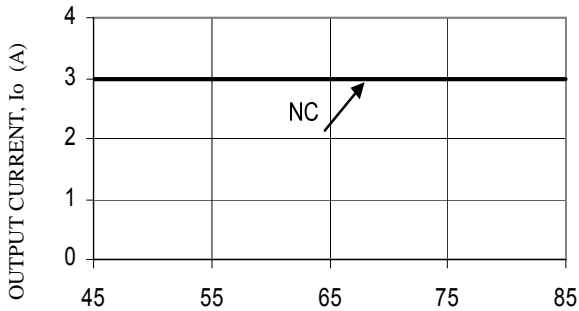

AMBIENT TEMPERATURE, T_A °C

$V_o=1.8V$

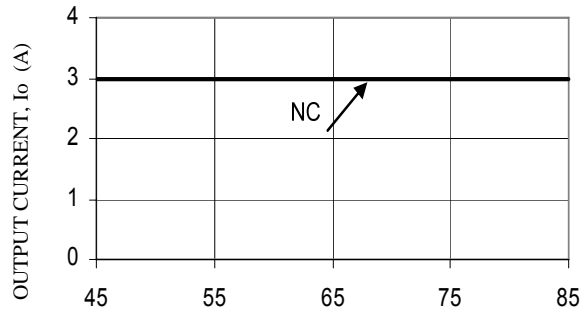

AMBIENT TEMPERATURE, T_A °C

$V_o=2.5V$

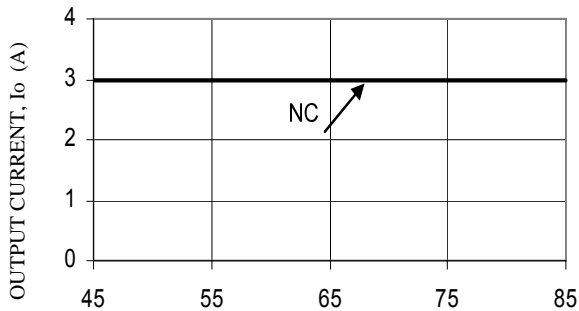

AMBIENT TEMPERATURE, T_A °C

$V_o=3.3V$

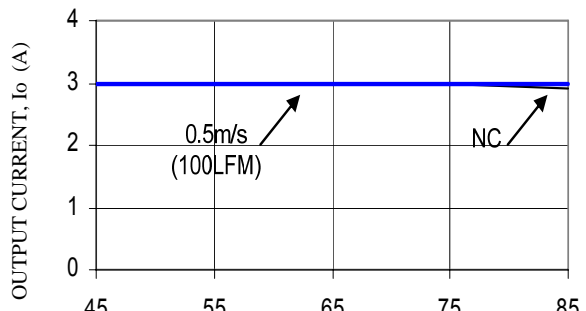

AMBIENT TEMPERATURE, T_A °C

$V_o=5.0V$

Ripple and Noise Waveforms

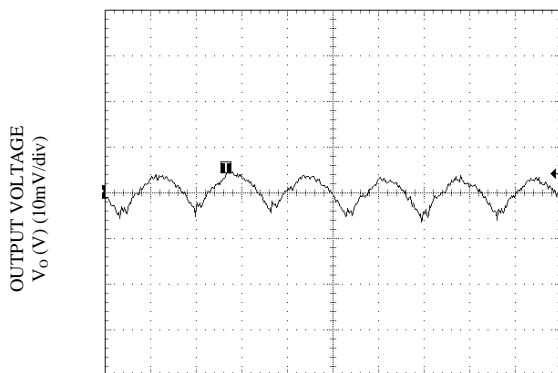

TIME, t (1µs/div)

Vin=12V, Vo=0.6V, Io = Io,max

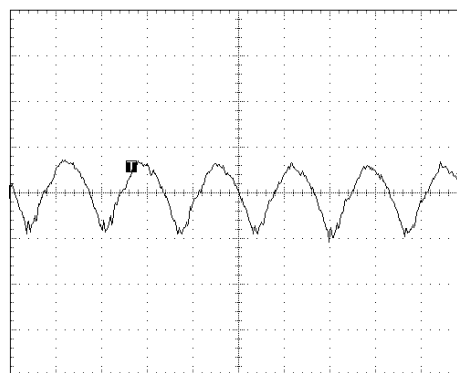

TIME, t (1µs/div)

Vin=12V, Vo=1.2V, Io = Io,max

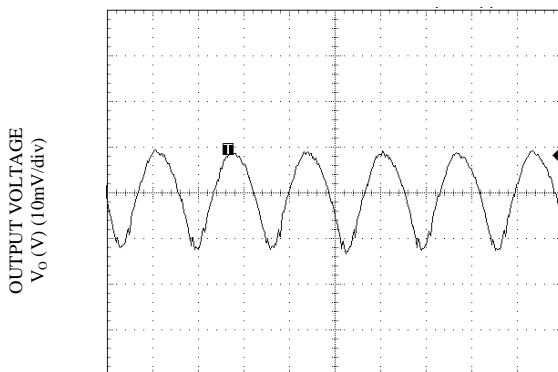

TIME, t (1µs/div)

Vin=12V, Vo=1.8V, Io = Io,max

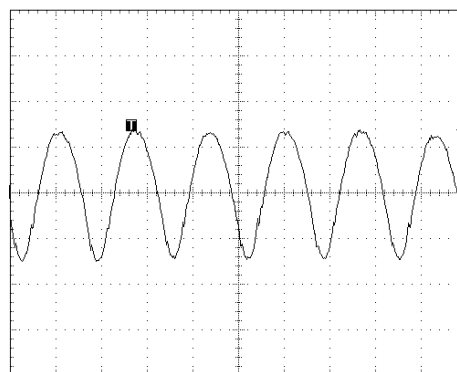

TIME, t (1µs/div)

Vin=12V, Vo=2.5V, Io = Io,max

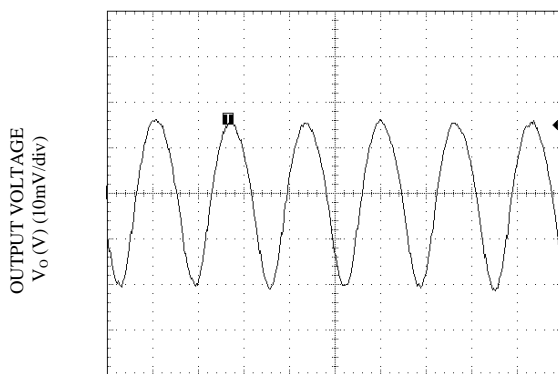

TIME, t (1µs/div)

Vin=12V, Vo=3.3V, Io = Io,max

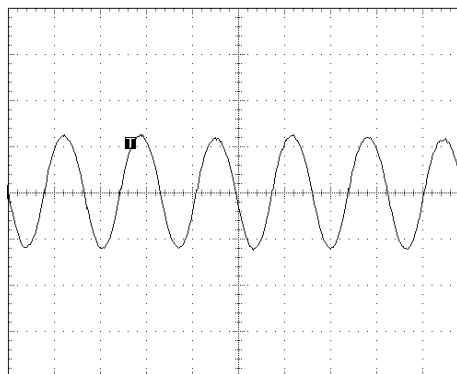

TIME, t (1µs/div)

Vin=12V, Vo=5.0V, Io = Io,max

Transient Response Waveforms

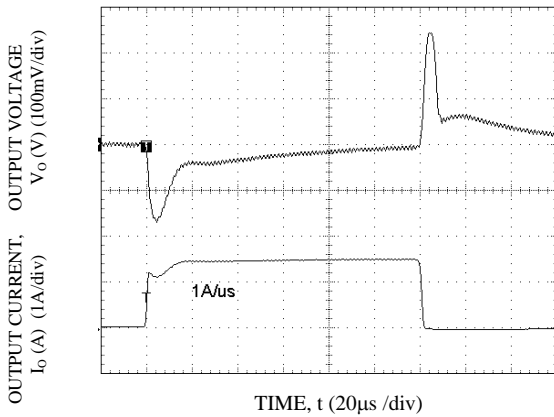

Transient Response to Dynamic Load Change from 0% to 50% to 0%. $V_o=0.6V$

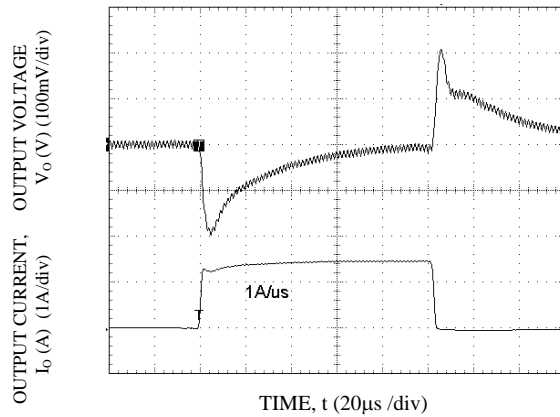

Transient Response to Dynamic Load Change from 0% to 50% to 0%. $V_o=1.2V$

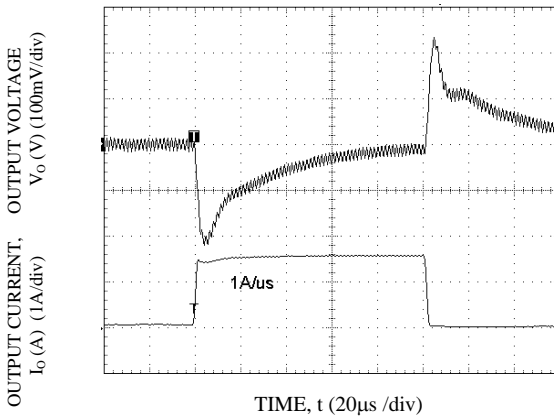

Transient Response to Dynamic Load Change from 0% to 50% to 0%. $V_o=1.8V$

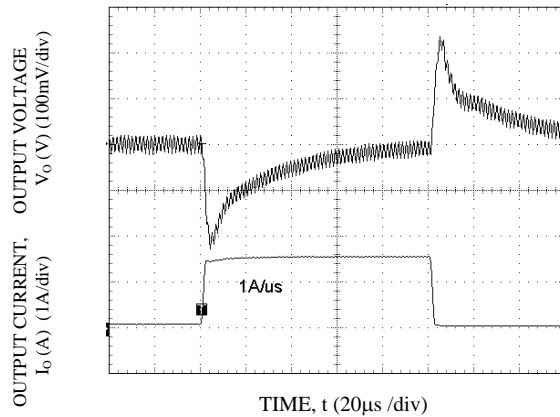

Transient Response to Dynamic Load Change from 0% to 50% to 0%. $V_o=2.5V$

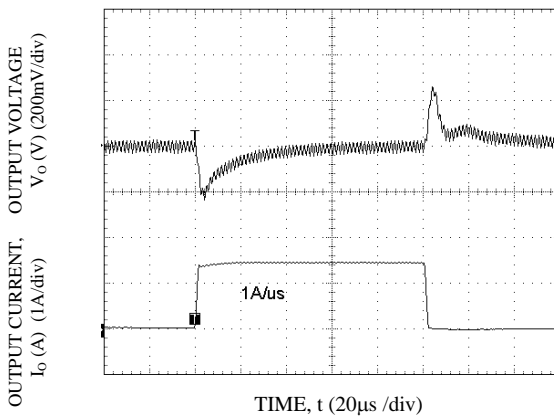

Transient Response to Dynamic Load Change from 0% to 50% to 0%. $V_o=3.3V$

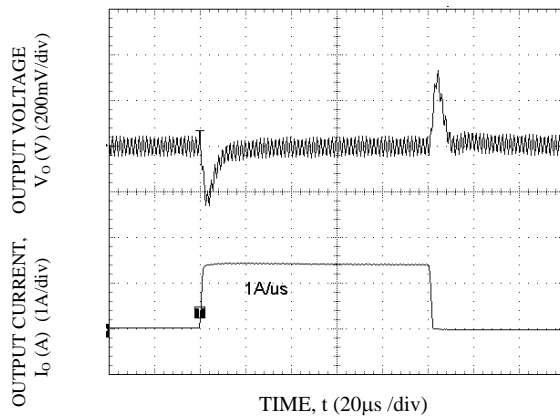

Transient Response to Dynamic Load Change from 0% to 50% to 0%. $V_o=5.0V$

Startup Time

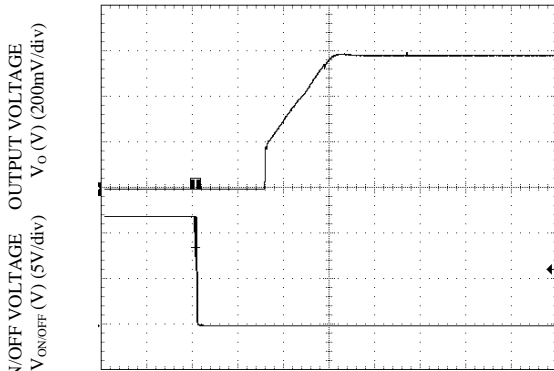

TIME, t (2 ms/div)

Start-up Using On/Off Voltage ($I_o = I_{o,max}$), $V_o=0.6V$

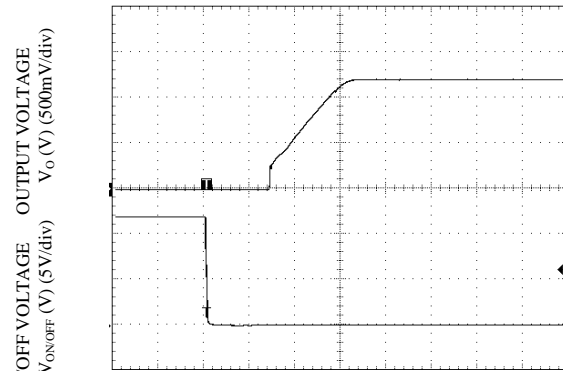

TIME, t (2 ms/div)

Start-up Using On/Off Voltage ($I_o = I_{o,max}$), $V_o=1.2V$

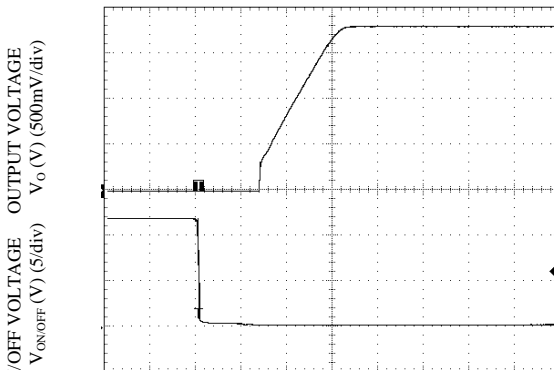

TIME, t (2 ms/div)

Start-up Using On/Off Voltage ($I_o = I_{o,max}$), $V_o=1.8V$

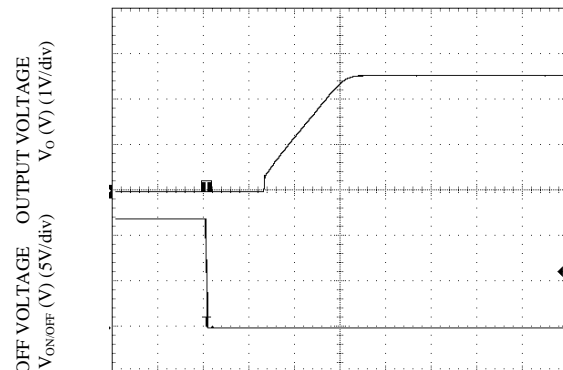

TIME, t (2 ms/div)

Start-up Using On/Off Voltage ($I_o = I_{o,max}$), $V_o=2.5V$

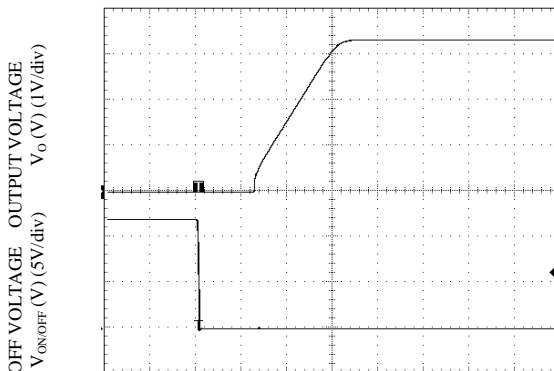

TIME, t (2 ms/div)

Start-up Using On/Off Voltage ($I_o = I_{o,max}$), $V_o=3.3V$

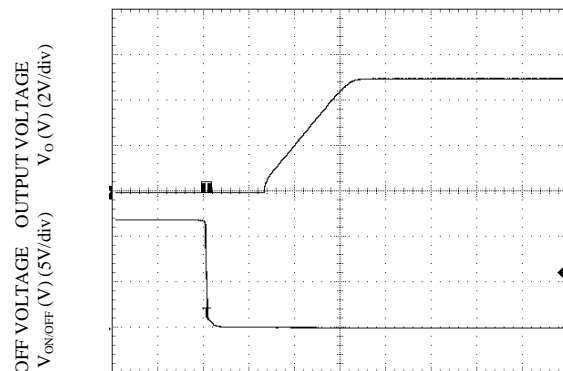

TIME, t (2 ms/div)

Start-up Using On/Off Voltage ($I_o = I_{o,max}$), $V_o=5.0V$

Startup Time (continued)

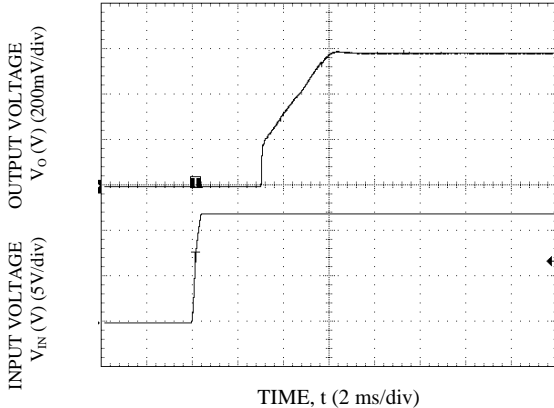

Start-up Using Input Voltage ($V_{IN} = 12V$, $I_o = I_{o,max}$), $V_o=0.6V$

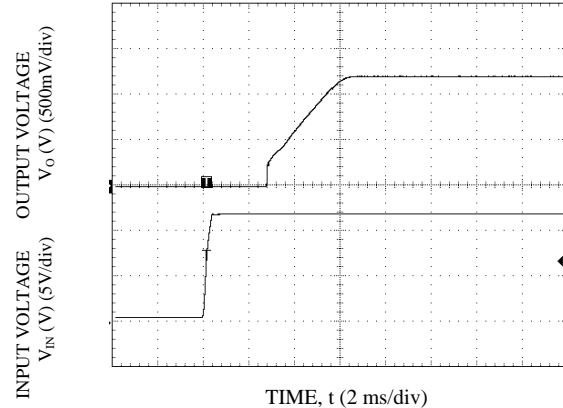

Start-up Using Input Voltage ($V_{IN} = 12V$, $I_o = I_{o,max}$), $V_o=1.2V$

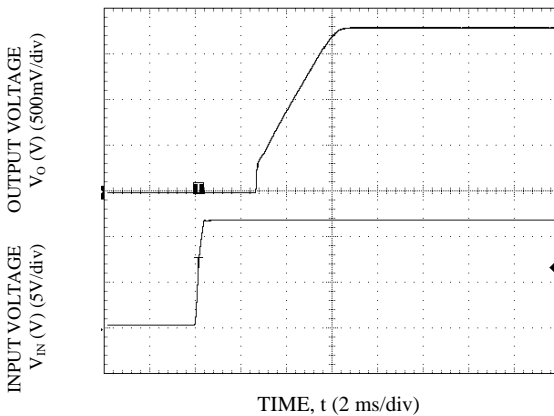

Start-up Using Input Voltage ($V_{IN} = 12V$, $I_o = I_{o,max}$), $V_o=1.8V$

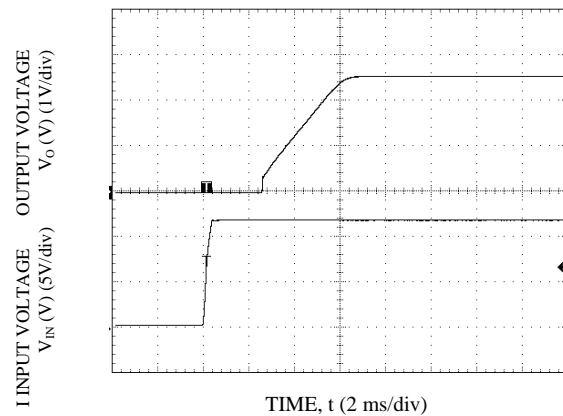

Start-up Using Input Voltage ($V_{IN} = 12V$, $I_o = I_{o,max}$), $V_o=2.5V$

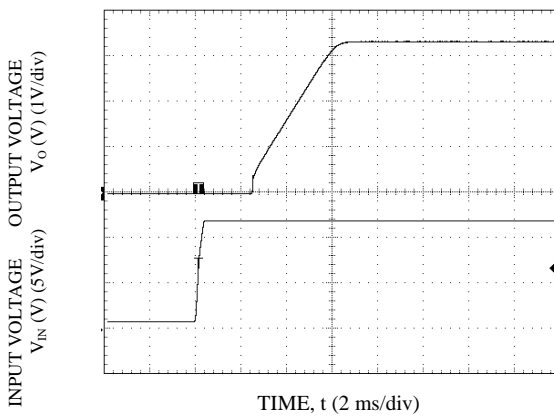

Start-up Using Input Voltage ($V_{IN} = 12V$, $I_o = I_{o,max}$), $V_o=3.3V$

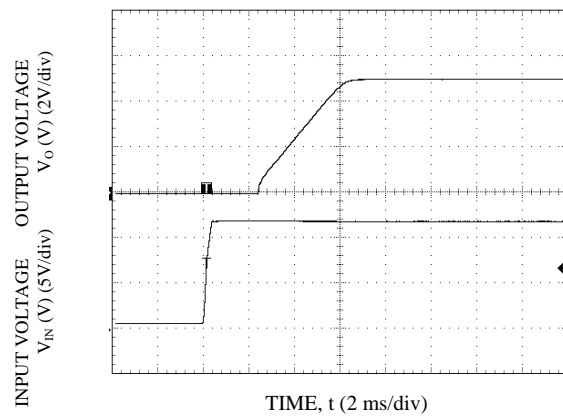

Start-up Using Input Voltage ($V_{IN} = 12V$, $I_o = I_{o,max}$), $V_o=5.0V$

NON-ISOLATED DC/DC CONVERTERS

4.5 Vdc - 14 Vdc Input, 0.59 Vdc - 5.5 Vdc / 3 A Outputs



December 3, 2010

Bel Power, Inc., a subsidiary of Bel Fuse, Inc.

Test Configurations

Input Reflected Ripple Current Test Setup.

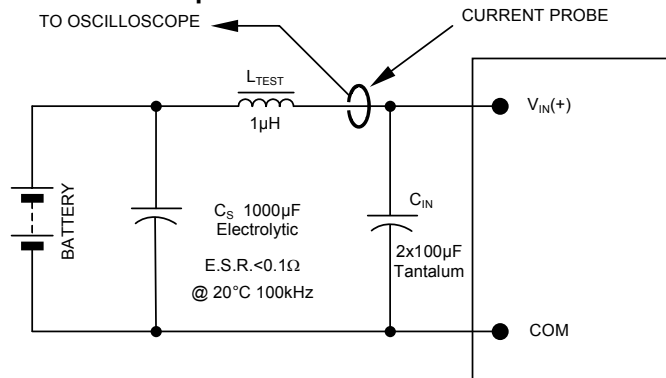

NOTE: Measure input reflected ripple current with a simulated source inductance (L_{TEST}) of $1\mu H$. Capacitor C_S offsets possible battery impedance. Measure current as shown above.

Output Ripple and Noise Test Setup

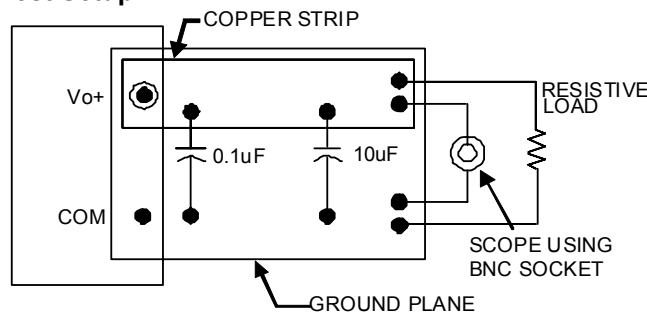

NOTE: All voltage measurements to be taken at the module terminals, as shown above. If sockets are used then Kelvin connections are required at the module terminals to avoid measurement errors due to socket contact resistance.

Output Voltage and Efficiency Test Setup

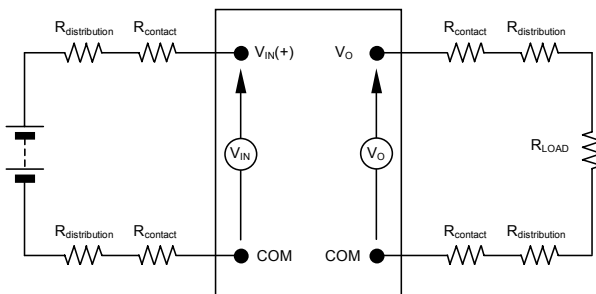

NOTE: All voltage measurements to be taken at the module terminals, as shown above. If sockets are used then Kelvin connections are required at the module terminals to avoid measurement errors due to socket contact resistance.

$$\text{Efficiency } \eta = \frac{V_O \cdot I_O}{V_{IN} \cdot I_{IN}} \times 100 \%$$

NON-ISOLATED DC/DC CONVERTERS

4.5 Vdc - 14 Vdc Input, 0.59 Vdc - 5.5 Vdc /3 A Outputs

bel

December 3, 2010

Bel Power, Inc. , a subsidiary of Bel Fuse, Inc.

Input Filtering

The SLIN-03E1Ax module should be connected to a low ac-impedance source. A highly inductive source can affect the stability of the module. Input capacitance must be placed directly adjacent to the input pin of the module, to minimize input ripple voltage and ensure module stability.

To minimize input voltage ripple, ceramic capacitors are recommended at the input of the module. The figure below shows the input ripple voltage for various output voltages at 3A of load current with 1x10 μ F or 1x22 μ F ceramic capacitors and an input of 12V.

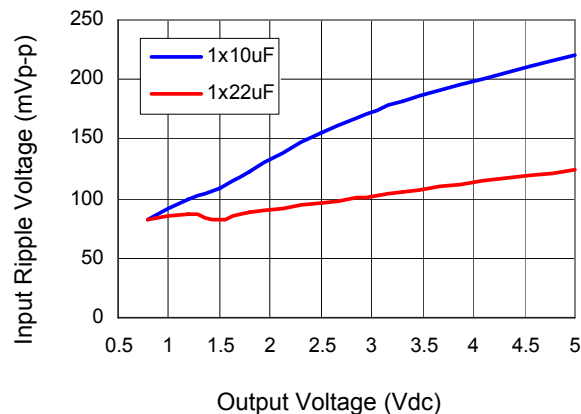

Output Filtering

The SLIN-03E1Ax modules are designed for low output ripple voltage and will meet the maximum output ripple specification with 0.1 μ F ceramic and 10 μ F ceramic capacitors at the output of the module. However, additional output filtering may be required by the system designer for a number of reasons. First, there may be a need to further reduce the output ripple and noise of the module. Second, the dynamic response characteristics may need to be customized to a particular load step change.

To reduce the output ripple and improve the dynamic response to a step load change, additional capacitance at the output can be used. Low ESR polymer and ceramic capacitors are recommended to improve the dynamic response of the module. The figure on the next page provides output ripple information for different external capacitance values at various V_o and for a load current of 3A. For stable operation of the module, limit the capacitance to less than the maximum output capacitance as specified in the electrical specification table. Optimal performance of the module can be achieved by using the Tunable Loop™ feature described later in this data sheet.

NON-ISOLATED DC/DC CONVERTERS

4.5 Vdc - 14 Vdc Input, 0.59 Vdc - 5.5 Vdc /3 A Outputs



December 3, 2010

Bel Power, Inc. , a subsidiary of Bel Fuse, Inc.

Output Filtering (continued)

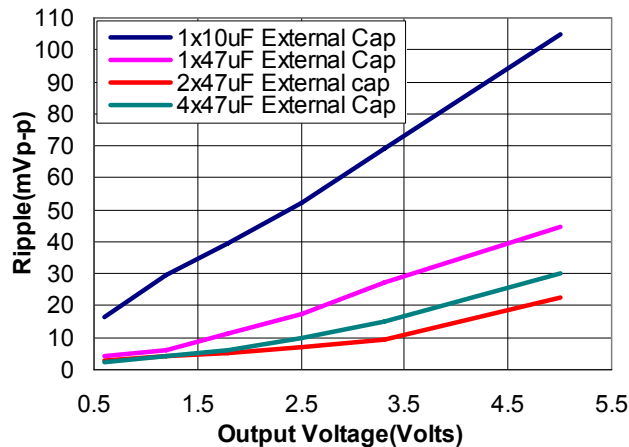

Note: Output ripple voltage for various output voltages with external 1x10 μ F, 1x47 μ F, 2x47 μ F or 4x47 μ F ceramic capacitors at the output (3A load). Input voltage is 12V.

Safety Considerations

For safety agency approval the power module must be installed in compliance with the spacing and separation requirements of the end-use safety agency standards, i.e., UL 60950-1, CSA C22.2 No. 60950-1-03, and VDE 0850:2001-12 (EN60950-1) Licensed.

For the converter output to be considered meeting the requirements of safety extra-low voltage (SELV), the input must meet SELV requirements. The power module has extra-low voltage (ELV) outputs when all inputs are ELV.

The input to these units is to be provided with a fast-acting fuse with a maximum rating of 5A in the positive input lead.

NON-ISOLATED DC/DC CONVERTERS

4.5 Vdc - 14 Vdc Input, 0.59 Vdc - 5.5 Vdc / 3 A Outputs



December 3, 2010

Bel Power, Inc., a subsidiary of Bel Fuse, Inc.

Remote On/Off

Parameter		Min	Typ	Max	Unit	Notes
Signal Low (Unit On)	Active Low	-0.2	-	0.6	V	The remote on/off pin open, Unit on.
Signal High (Unit Off)		3.5	-	V _{in,max}	V	
Signal Low (Unit Off)	Active High	-0.3	-	0.8	V	The remote on/off pin open, Unit on.
Signal High (Unit On)		3.5	-	V _{in,max}	V	

The SLIN-03E1Ax modules feature an On/Off pin for remote On/Off operation. Two On/Off logic options are available. In the Positive Logic On/Off option, the module turns ON during a logic High on the On/Off pin and turns OFF during a logic Low. With the Negative Logic On/Off option, the module turns OFF during logic High and ON during logic Low. The On/Off signal is always referenced to ground. For either On/Off logic option, leaving the On/Off pin disconnected will turn the module ON when input voltage is present.

For positive logic modules, the circuit configuration for using the On/Off pin is shown in the figure below. When the external transistor Q1 is in the OFF state, the internal PWM Enable signal is pulled high through an internal 1.5MΩ resistor and the external pullup resistor and the module is ON. When transistor Q1 is turned ON, the On/Off pin is pulled low and the module is OFF. A suggested value for R_{pullup} is 20kΩ.

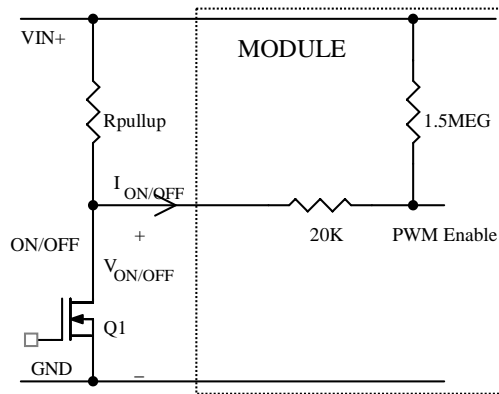

Circuit configuration for using positive On/Off logic

For negative logic On/Off modules, the circuit configuration is shown below. The On/Off pin should be pulled high with an external pull-up resistor (suggested value for the 4.5V to 14V input range is 20Kohms). When transistor Q2 is in the OFF state, the On/Off pin is pulled high, transistor Q1 is turned ON and the module is OFF. To turn the module ON, Q2 is turned ON pulling the On/Off pin low, turning transistor Q1 OFF resulting in the PWM Enable pin going high.

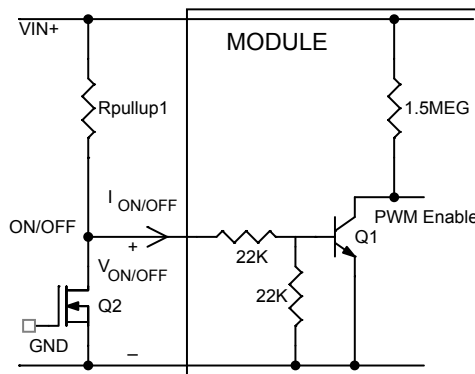

Circuit configuration for using negative On/Off logic

Over Current Protection

To provide protection in a fault (output overload) condition, the unit is equipped with internal current-limiting circuitry and can endure current limiting continuously. At the point of current-limit inception, the unit enters hiccup mode. The unit operates normally once the output current is brought back into its specified range.

Over Temperature Protection

To provide protection in a fault condition, the unit is equipped with a thermal shutdown circuit. The unit will shutdown if the over temperature threshold of 140°C is exceeded at the thermal reference point Tref. The thermal shutdown is not intended as a guarantee that the unit will survive temperatures beyond its rating. Once the unit goes into thermal shutdown it will then wait to cool before attempting to restart.

Input Under-voltage Lockout

At input voltages below the input under voltage lockout limit, the module operation is disabled. The module will begin to operate at an input voltage above the under voltage lockout turn-on threshold.

Output Voltage Programming

The output voltage of the SLIN-03E1Ax module can be programmed to any voltage from 0.59dc to 5.5Vdc by connecting a resistor between the Trim and GND pins of the module. Certain restrictions apply on the output voltage set point depending on the input voltage. These are shown in the Output Voltage vs. Input Voltage Set Point Area plot below. The Upper Limit curve shows that for output voltages of 0.9V and lower, the input voltage must be lower than the maximum of 14V. The Lower Limit curve shows that for output voltages of 3.8V and higher, the input voltage needs to be larger than the minimum of 4.5V.

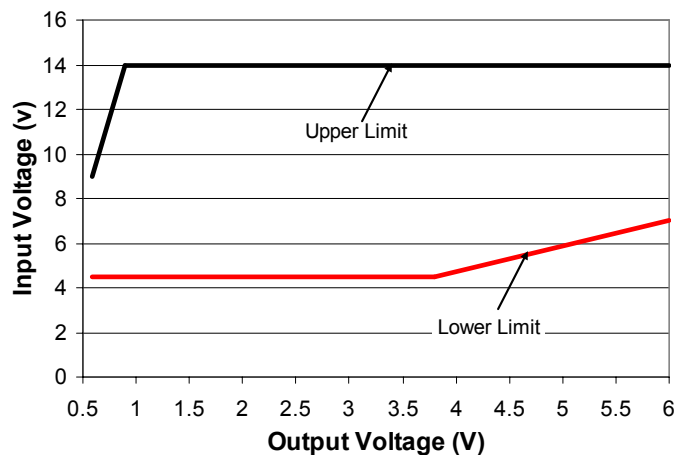

Output Voltage vs. Input Voltage Set Point Area plot showing limits where the output voltage can be set for different input voltages.

Output Trim Equations

Without an external resistor between Trim and GND pins, the output of the module will be 0.59Vdc. To calculate the value of the trim resistor, R_{trim} , for a desired output voltage, use the following equation:

$$R_{trim} = \left[\frac{5.91}{(V_o - 0.591)} \right] k\Omega$$

R_{trim} is the external resistor in $k\Omega$
 V_o is the desired output voltage.

Table 1 provides R_{trim} values required for some common output voltages.

Table 1

$V_{O, set} (V)$	$R_{trim} (K\Omega)$
0.6	656.7
1.0	14.45
1.2	9.704
1.5	6.502
1.8	4.888
2.5	3.096
3.3	2.182
5.0	1.340

By using a $\pm 0.5\%$ tolerance trim resistor with a TC of $\pm 100\text{ppm}$, a set point tolerance of $\pm 1.5\%$ can be achieved as specified in the electrical specification.

Remote Sense

The SLIN-03E1Ax modules have a Remote Sense feature to minimize the effects of distribution losses by regulating the voltage at the SENSE pin. The voltage between the SENSE pin and VOUT pin must not exceed 0.5V. Note that the output voltage of the module cannot exceed the specified maximum value. This includes the voltage drop between the SENSE and Vout pins. When the Remote Sense feature is not being used, connect the SENSE pin to the VOUT pin.

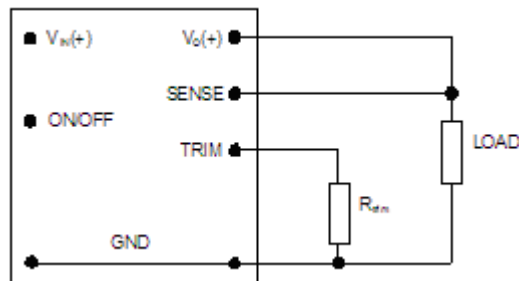

Circuit configuration for programming output voltage using an external resistor

NON-ISOLATED DC/DC CONVERTERS

4.5 Vdc - 14 Vdc Input, 0.59 Vdc - 5.5 Vdc /3 A Outputs

bel

December 3, 2010

Bel Power, Inc. , a subsidiary of Bel Fuse, Inc.

Voltage Margining

Output voltage margining can be implemented in the SLIN-03E1Ax modules by connecting a resistor, $R_{\text{margin-up}}$, from the Trim pin to the ground pin for margining-up the output voltage and by connecting a resistor, $R_{\text{margin-down}}$, from the Trim pin to output pin for margining-down.

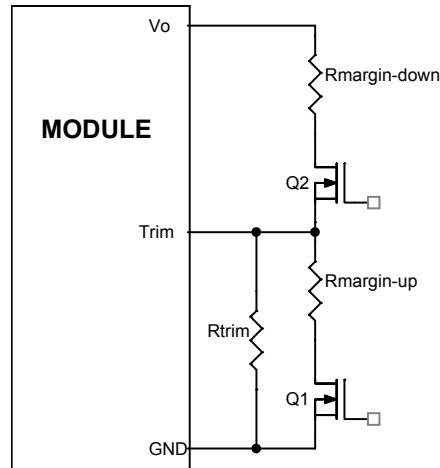

Circuit Configuration for margining Output voltage

Monotonic Start-up and Shutdown

The SLIN-03E1Ax modules have monotonic start-up and shutdown behavior for any combination of rated input voltage, output current and operating temperature range.

Startup into Pre-biased Output

The SLIN-03E1Ax modules can start into a prebiased output as long as the prebias voltage is 0.5V less than the set output voltage. Note that prebias operation is not supported when output voltage sequencing is used.

Output Voltage Sequencing

The SLIN-03E1Ax modules include a sequencing feature that enables users to implement various types of output voltage sequencing in their applications. This is accomplished via an additional sequencing pin. When not using the sequencing feature, either tie the SEQ pin to VIN or leave it unconnected.

When an analog voltage is applied to the SEQ pin, the output voltage tracks this voltage until the output reaches the set-point voltage. The final value of the SEQ voltage must be set higher than the set-point voltage of the module. The output voltage follows the voltage on the SEQ pin on a one-to-one volt basis. By connecting multiple modules together, multiple modules can track their output voltages to the voltage applied on the SEQ pin.

For proper voltage sequencing, first, input voltage is applied to the module. The On/Off pin of the module is left unconnected (or tied to GND for negative logic modules or tied to VIN for positive logic modules) so that the module is ON by default.

NON-ISOLATED DC/DC CONVERTERS

4.5 Vdc - 14 Vdc Input, 0.59 Vdc - 5.5 Vdc /3 A Outputs

December 3, 2010

Bel Power, Inc. , a subsidiary of Bel Fuse, Inc.

Output Voltage Sequencing (continued)

After applying input voltage to the module, a minimum 10msec delay is required before applying voltage on the SEQ pin. During this time, a voltage of 50mV (± 20 mV) is maintained on the SEQ pin. This delay gives the module enough time to complete its internal power-up soft-start cycle. During the delay time, the SEQ pin should be held close to ground (nominally 50mV ± 20 mV). This is required to keep the internal op-amp out of saturation thus preventing output overshoot during the start of the sequencing ramp. By selecting resistor R1 according to the following equation:

$$R1 = \frac{24950}{V_{IN} - 0.05} \text{ ohms}$$

The voltage at the sequencing pin will be 50mV when the sequencing signal is at zero.

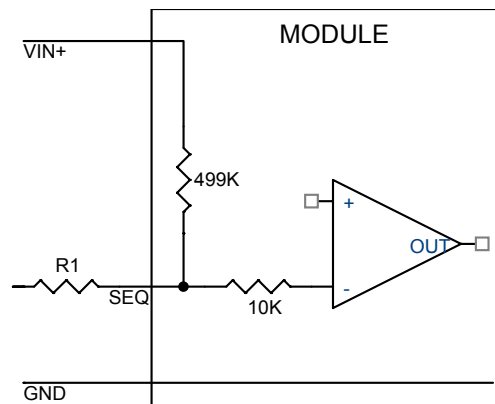

Circuit showing connection of the sequencing signal to the SEQ pin

After the 10msec delay, an analog voltage is applied to the SEQ pin and the output voltage of the module will track this voltage on a one-to-one volt basis until the output reaches the set-point voltage. To initiate simultaneous shutdown of the modules, the SEQ pin voltage is lowered in a controlled manner. The output voltage of the modules tracks the voltages below their set-point voltages on a one-to-one basis. A valid input voltage must be maintained until the tracking and output voltages reach ground potential.

When using the sequencing feature to control start-up of the module, pre-bias immunity during start-up is disabled. The pre-bias immunity feature of the module relies on the module being in the diode-mode during start-up. When using the sequencing feature, modules goes through an internal set-up time of 10msec, and will be in synchronous rectification mode when the voltage at the SEQ pin is applied. This will result in the module sinking current if a pre-bias voltage is present at the output of the module. When pre-bias immunity during start-up is required, the sequencing feature must be disabled. For additional guidelines on using the sequencing feature please contact the Bel Power technical representative for additional information.

NON-ISOLATED DC/DC CONVERTERS

4.5 Vdc - 14 Vdc Input, 0.59 Vdc - 5.5 Vdc /3 A Outputs

December 3, 2010

Bel Power, Inc. , a subsidiary of Bel Fuse, Inc.

Power Good

The SLIN-03E1Ax modules provide a Power Good (PGOOD) signal that is implemented with an open-drain output to indicate that the output voltage is within the regulation limits of the power module. The PGOOD signal will be de-asserted to a low state if any condition such as over temperature, over current or loss of regulation occurs that would result in the output voltage going $\pm 10\%$ outside the set-point value. The PGOOD terminal should be connected through a pull-up resistor (suggested value 100K Ω) to a source of 5VDC or lower.

Tunable Loop™



The SLIN-03E1Ax modules have a new feature that optimizes transient response of the module called Tunable Loop™.

External capacitors are usually added to the output of the module for two reasons: to reduce output ripple and noise and to reduce output voltage deviations from the steady-state value in the presence of dynamic load current changes. Adding external capacitance however affects the voltage control loop of the module, typically causing the loop to slow down with sluggish response. Larger values of external capacitance could also cause the module to become unstable.

The Tunable Loop™ allows the user to externally adjust the voltage control loop to match the filter network connected to the output of the module. The Tunable Loop™ is implemented by connecting a series R-C between the SENSE and TRIM pins of the module, as shown below. This R-C allows the user to externally adjust the voltage loop feedback compensation of the module.

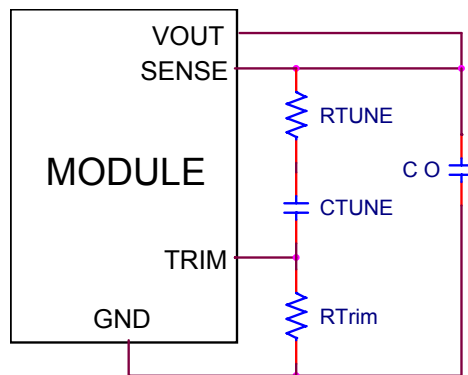

Circuit diagram showing connection of R_{TUNE} and C_{TUNE} to tune the control loop of the module

Recommended values of R_{TUNE} and C_{TUNE} for different output capacitor combinations are given in Tables 2 and 3. Table 2 shows the recommended values of R_{TUNE} and C_{TUNE} for different values of ceramic output capacitors up to 470uF that might be needed for an application to meet output ripple and noise requirements. Selecting R_{TUNE} and C_{TUNE} according to Table 2 will ensure stable operation of the module.

In applications with tight output voltage limits in the presence of dynamic current loading, additional output capacitance will be required. Table 3 lists recommended values of R_{TUNE} and C_{TUNE} in order to meet 2% output voltage deviation limits for some common output voltages in the presence of a 1.5A to 3A step change (50% of full load), with an input voltage of 12V.

NON-ISOLATED DC/DC CONVERTERS

4.5 Vdc - 14 Vdc Input, 0.59 Vdc - 5.5 Vdc /3 A Outputs



December 3, 2010

Bel Power, Inc., a subsidiary of Bel Fuse, Inc.

Tunable Loop™ (continued)

Table 2. General recommended values of R_{TUNE} and C_{TUNE} for $V_{in}=12V$ and various external ceramic capacitor combinations.

Co	1x47 μ F	2x47 μ F	4x47 μ F	6x47 μ F	10x47 μ F
R_{TUNE}	270	180	100	75	75
C_{TUNE}	2200pF	4700pF	18nF	18nF	22nF

Table 3. Recommended values of R_{TUNE} and C_{TUNE} to obtain transient deviation of $\leq 2\%$ of V_{out} for a 1.5A step load with $V_{in}=12V$.

V_o	5V	3.3V	2.5V	1.8V	1.2V	0.6V
Co	1x22 μ F	1x47 μ F	2x47 μ F	2x47 μ F	3x47 μ F	1x47 μ F+330 μ F Polymer
R_{TUNE}	270	270	180	150	150	100
C_{TUNE}	820pF	2200pF	4700pF	4700pF	10nF	15nF
ΔV	100mV	64mV	37mV	36mV	22mV	12mV

Thermal Considerations

Power modules operate in a variety of thermal environments; however, sufficient cooling should always be provided to help ensure reliable operation.

Considerations include ambient temperature, airflow, module power dissipation, and the need for increased reliability. A reduction in the operating temperature of the module will result in an increase in reliability. The thermal data presented here is based on physical measurements taken in a wind tunnel.

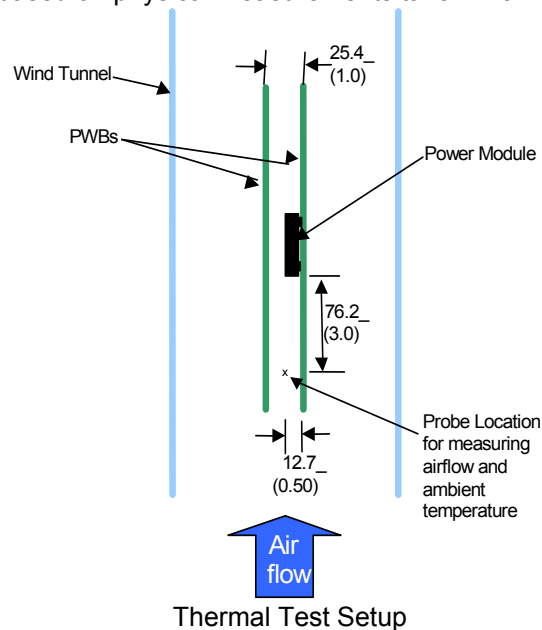

NON-ISOLATED DC/DC CONVERTERS

4.5 Vdc - 14 Vdc Input, 0.59 Vdc - 5.5 Vdc / 3 A Outputs



December 3, 2010

Bel Power, Inc., a subsidiary of Bel Fuse, Inc.

Thermal Considerations (continued)

The thermal reference points, T_{ref} , used in the specifications are also shown below. For reliable operation the temperatures at these points should not exceed 120°C . The output power of the module should not exceed the rated power of the module ($V_{o,set} \times I_{o,max}$).

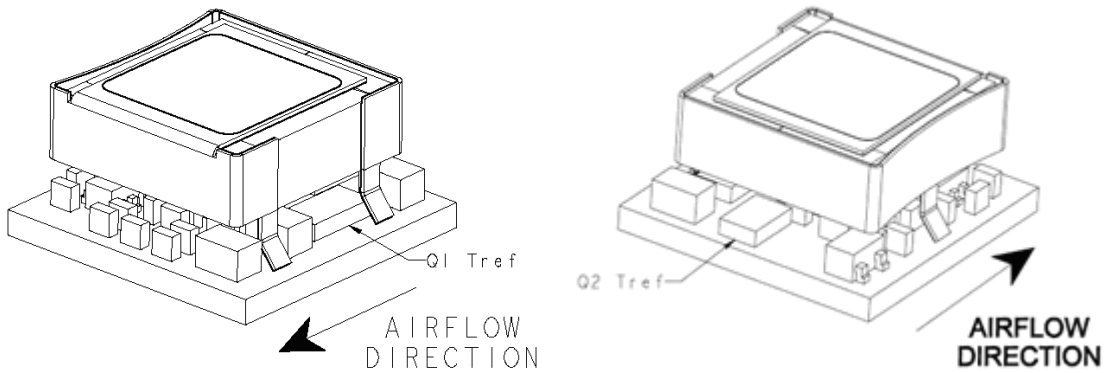

Preferred airflow direction and location of hot-spots of the module (T_{ref}).

Example Application Circuit

Requirements:

V_{in} : 12V
 V_{out} : 1.8V
 I_{out} : 2.25A max., worst case load transient is from 1.5A to 2.25A
 ΔV_{out} : 1.5% of V_{out} (27mV) for worst case load transient
 V_{in} , ripple: 1.5% of V_{in} (180mV, p-p)

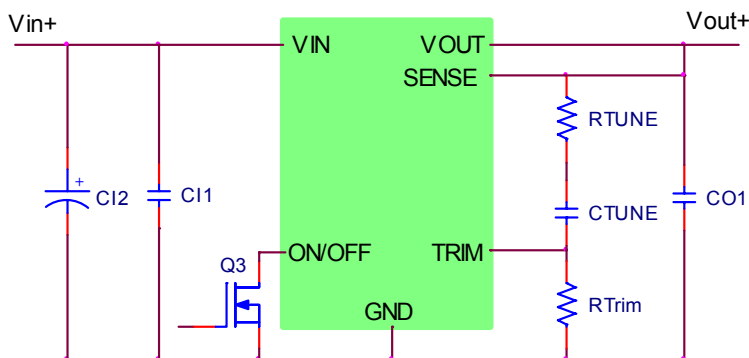

C11 10 μF /16V ceramic capacitor (e.g. Murata GRM Series)
C12 47 μF /16V bulk electrolytic
CO1 2 x 47 μF /6.3V ceramic capacitor (e.g. TDK C Series)
CTune 4.7nF ceramic capacitor (can be 1206, 0805 or 0603 size)
RTune 180 ohms SMT resistor (can be 1206, 0805 or 0603 size)
RTrim 4.87k Ω SMT resistor (can be 1206, 0805 or 0603 size, recommended tolerance of 0.1%)

NON-ISOLATED DC/DC CONVERTERS

4.5 Vdc - 14 Vdc Input, 0.59 Vdc - 5.5 Vdc / 3 A Outputs



December 3, 2010

Bel Power, Inc., a subsidiary of Bel Fuse, Inc.

Mechanical Outline

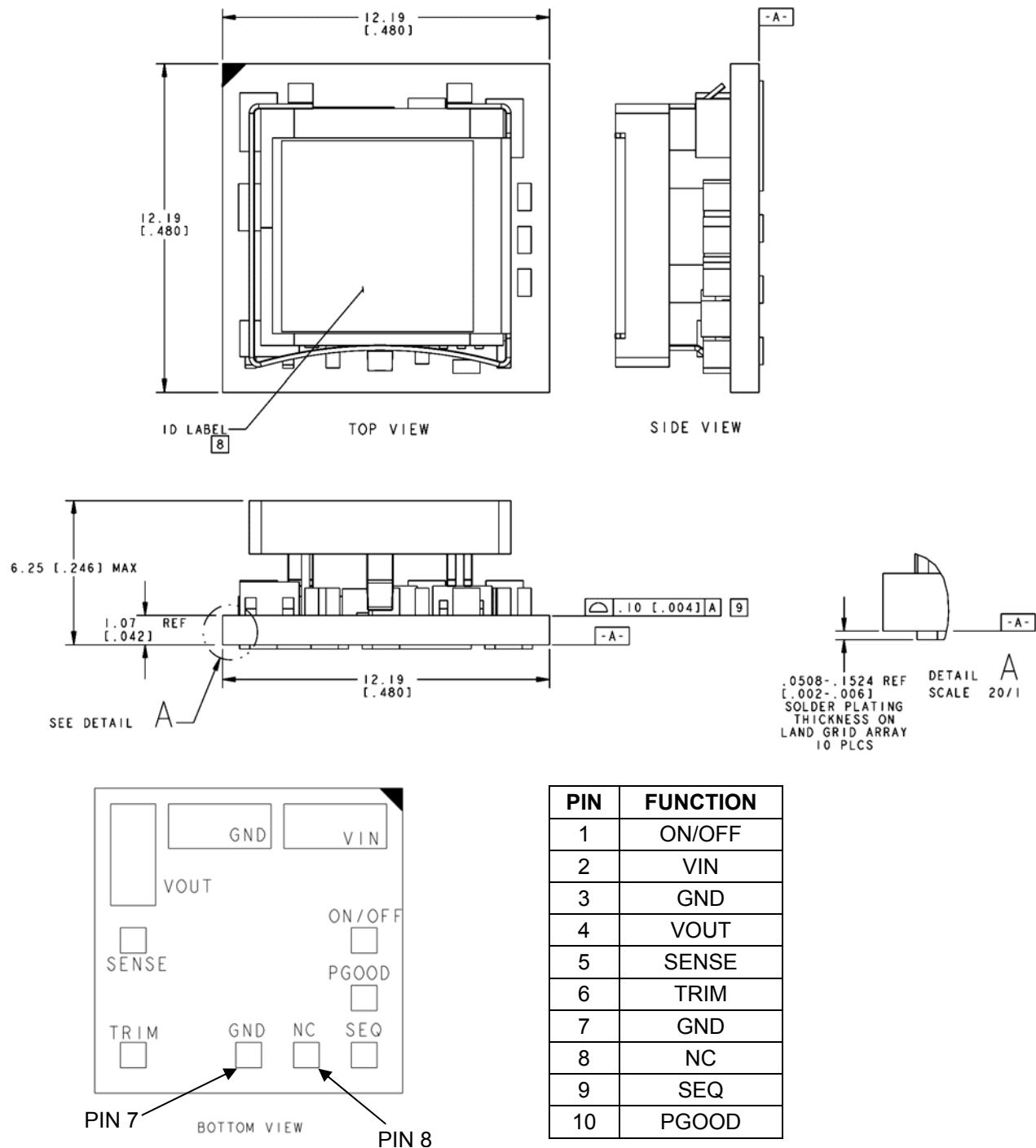

NON-ISOLATED DC/DC CONVERTERS

4.5 Vdc - 14 Vdc Input, 0.59 Vdc - 5.5 Vdc /3 A Outputs



December 3, 2010

Bel Power, Inc., a subsidiary of Bel Fuse, Inc.

Mechanical Outline (continued)

Recommended Pad Layout

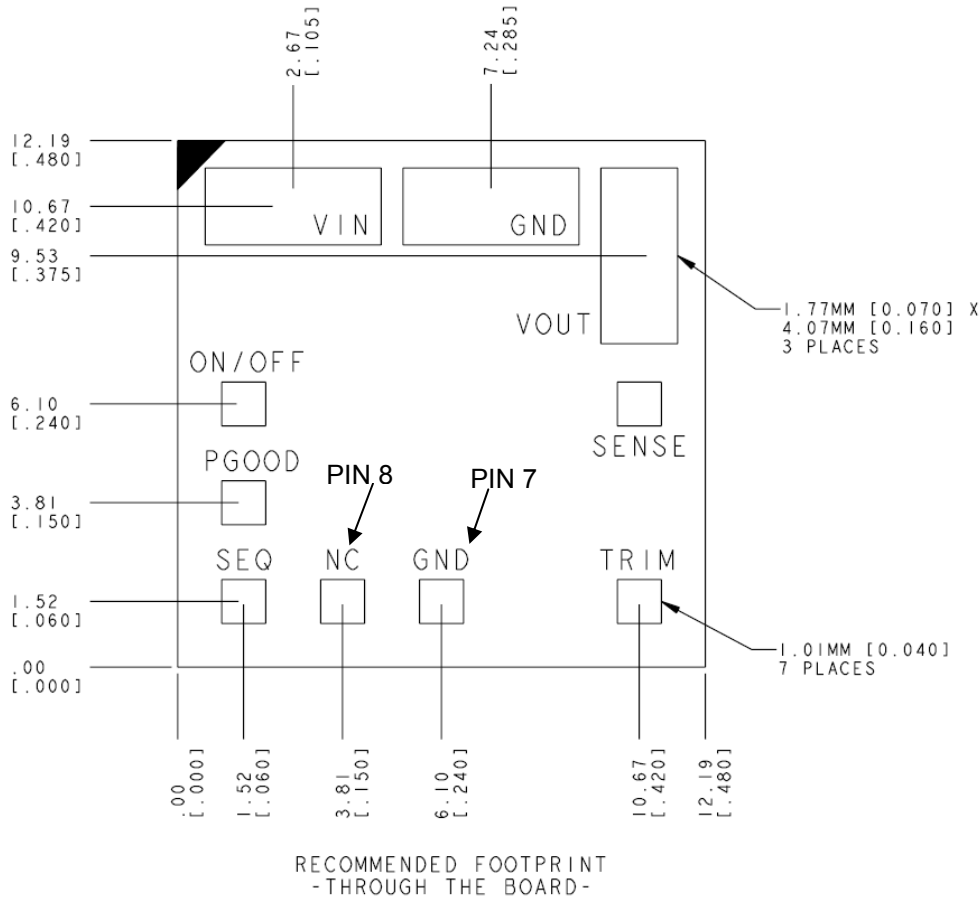

Dimensions are in millimeters and (inches).

Tolerances: x.x mm \pm 0.5 mm (x.xx in. \pm 0.02 in.) [unless otherwise indicated]

x.xx mm \pm 0.25 mm (x.xxx in. \pm 0.010 in.)

Note: This module is recommended and compatible with Pb-Free Reflow Soldering and must be soldered using a reflow profile with a peak temperature of no more than 260°C for less than 5 seconds.

NON-ISOLATED DC/DC CONVERTERS

4.5 Vdc - 14 Vdc Input, 0.59 Vdc - 5.5 Vdc / 3 A Outputs



December 3, 2010

Bel Power, Inc., a subsidiary of Bel Fuse, Inc.

Packaging Details

The SLIN-03E1Ax modules are supplied in tape & reel as standard.

All Dimensions are in millimeters and (in inches).

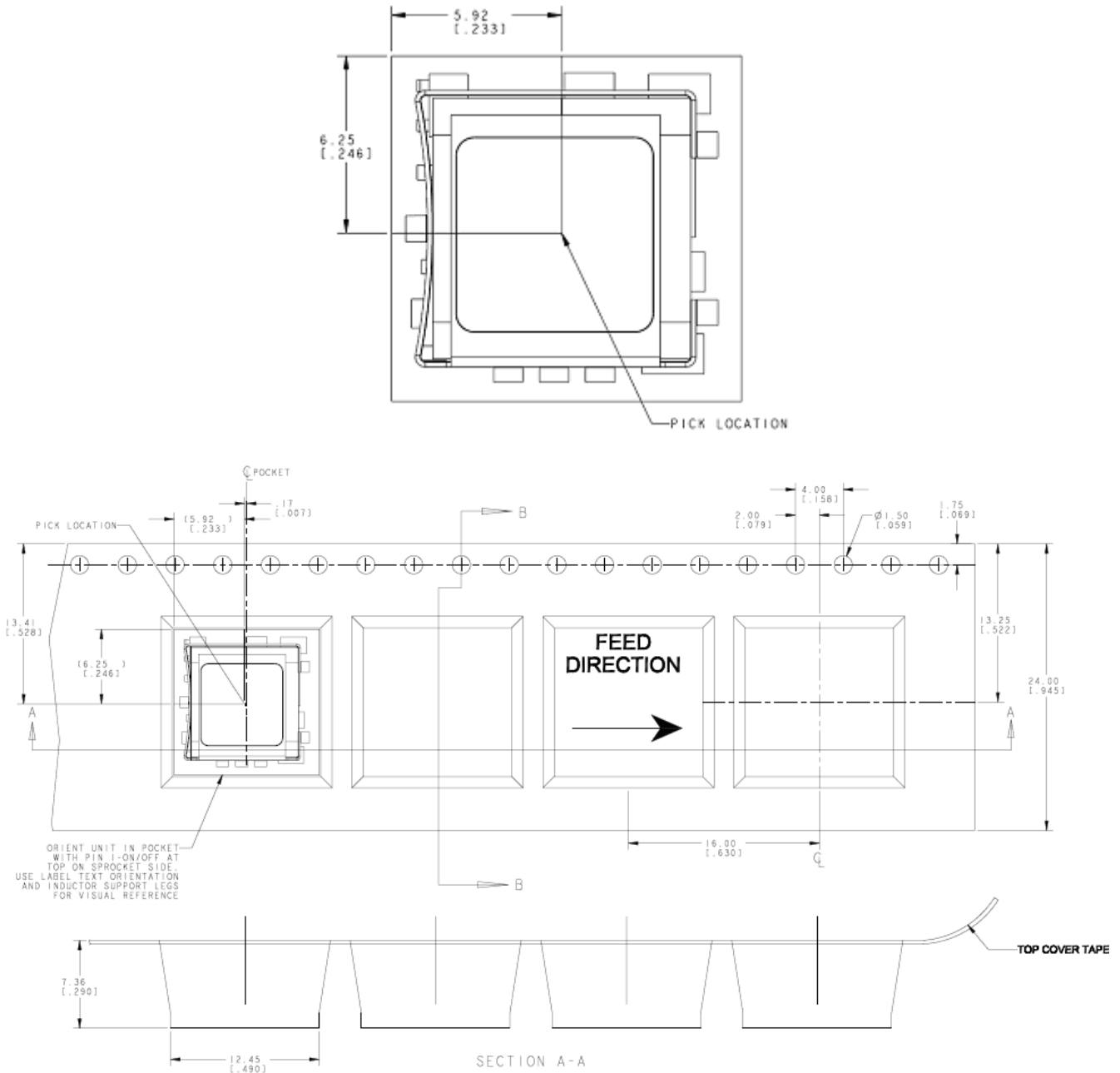

- Reel Dimensions:
- Outside Dimensions: 330.2 mm (13.00)
- Inside Dimensions: 177.8 mm (7.00")
- Tape Width: 24.00 mm (0.945")

NON-ISOLATED DC/DC CONVERTERS

4.5 Vdc - 14 Vdc Input, 0.59 Vdc - 5.5 Vdc /3 A Outputs



December 3, 2010

Bel Power, Inc. , a subsidiary of Bel Fuse, Inc.

Surface Mount Information

Pick and Place

The SLIN-03E1Ax modules use an open frame construction and are designed for a fully automated assembly process. The modules are fitted with a label designed to provide a large surface area for pick and place operations. The label meets all the requirements for surface mount processing, as well as safety standards, and is able to withstand reflow temperatures of up to 300°C. The label also carries product information such as part number and serial number.

Nozzle Recommendations

The module weight has been kept to a minimum by using open frame construction. Variables such as nozzle size, tip style, vacuum pressure and placement speed should be considered to optimize this process. The minimum recommended inside nozzle diameter for reliable operation is 3mm. The maximum nozzle outer diameter, which will safely fit within the allowable component spacing, is 7 mm.

Lead Free Soldering

The SLIN-03E1Ax modules are lead-free (Pb-free) and RoHS compliant and fully compatible in a Pb-free soldering process. Failure to observe the instructions below may result in the failure of or cause damage to the modules and can adversely affect long-term reliability.

Pb-Free Reflow Profile

Power Systems will comply with J-STD-020 Rev. C (Moisture/Reflow Sensitivity Classification for Nonhermetic Solid State Surface Mount Devices) for both Pb-free solder profiles and MSL classification procedures. This standard provides a recommended forced-air-convection reflow profile based on the volume and thickness of the package. The suggested Pb-free solder paste is Sn/Ag/Cu (SAC). The recommended linear reflow profile using Sn/Ag/Cu solder is shown in the figure below. Soldering outside of the recommended profile requires testing to verify results and performance.

MSL Rating

The SLIN-03E1Ax modules have a MSL rating of 2.

Storage and Handling

The recommended storage environment and handling procedures for moisture-sensitive surface mount packages is detailed in J-STD-033 Rev. A (Handling, Packing, Shipping and Use of Moisture/Reflow Sensitive Surface Mount Devices). Moisture barrier bags (MBB) with desiccant are required for MSL ratings of 2 or greater. These sealed packages should not be broken until time of use. Once the original package is broken, the floor life of the product at conditions of $\leq 30^{\circ}\text{C}$ and 60% relative humidity varies according to the MSL rating (see J-STD-033A). The shelf life for dry packed SMT packages will be a minimum of 12 months from the bag seal date, when stored at the following conditions: $< 40^{\circ}\text{C}$, $< 90\%$ relative humidity.

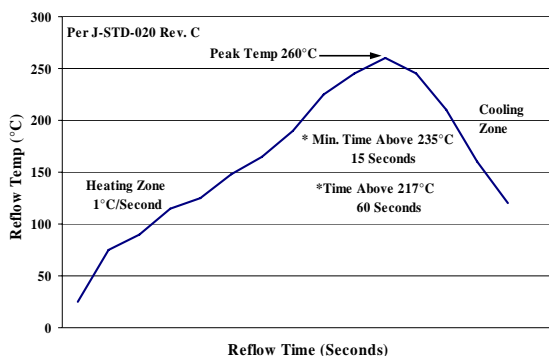

Recommended linear reflow profile using Sn/Ag/Cu solder.

NON-ISOLATED DC/DC CONVERTERS

4.5 Vdc - 14 Vdc Input, 0.59 Vdc - 5.5 Vdc /3 A Outputs



December 3, 2010

Bel Power, Inc. , a subsidiary of Bel Fuse, Inc.

Surface Mount Information (Continued)

Post Solder Cleaning and Drying Considerations

Post solder cleaning is usually the final circuit-board assembly process prior to electrical board testing. The result of inadequate cleaning and drying can affect both the reliability of a power module and the testability of the finished circuit-board assembly.

Revision History

Date	Revision	Changes Detail	Approval
2009-6-10	A	First release	T. Bubriski
2009-6-25	B	Section "Surface Mount Information" added.	T. Bubriski
2009-9-1	C	Tunable Loop™ logo added.	T. Bubriski
2009-10-8	D	Updated Startup Time waveforms on page 10.	T. Bubriski
2010-1-19	E	Updated Remote ON/OFF table on page 14.	T. Bubriski
2010-11-22	F	Updated UVLO Turn-on and Turn-off Thresholds on page 2, Output Short-circuit Current on page 3, Derating Curves on page 6, and Example Application Circuit on page 21.	T. Bubriski

RoHS Compliance

Complies with the European Directive 2002/95/EC, calling for the elimination of lead and other hazardous substances from electronic products.



©2009 Bel Fuse Inc. Specifications subject to change without notice. 12/3/10

26

CORPORATE

Bel Fuse Inc.
206 Van Vorst Street
Jersey City, NJ 07302
Tel 201-432-0463
Fax 201-432-9542
www.belfuse.com

FAR EAST

Bel Fuse Ltd.
8F/ 8 Luk Hop Street
San Po Kong
Kowloon, Hong Kong
Tel 852-2328-5515
Fax 852-2352-3706
www.belfuse.com

EUROPE

Bel Fuse Europe Ltd.
Preston Technology Management Centre
Marsh Lane, Suite G7, Preston
Lancashire, PR1 8UD, U.K.
Tel 44-1772-556601
Fax 44-1772-888366
www.belfuse.com