

DATA SHEET

GENERAL PURPOSE CHIP RESISTORS

RC0402 (Pb Free)
5%, 1%



Product specification – Sep 03, 2004 V.2



SCOPE

This specification describes RC0402 series chip resistors with lead-free terminations made by thick film process.

ORDERING INFORMATION

Part number is identified by the series, size, tolerance, packing type, temperature coefficient, taping reel and resistance value.

YAGEO ORDERING CODE

CTC CODE

RC0402 **X** **X** **X** **XX** **XXXX** **L**
(1) (2) (3) (4) (5) (6)

(1) TOLERANCE

F = $\pm 1\%$

J = $\pm 5\%$

(2) PACKAGING TYPE

R = Paper/PE taping reel

(3) TEMPERATURE COEFFICIENT OF RESISTANCE

– = Base on spec

(4) TAPING REEL

07 = 7 inch dia. Reel

10 = 10 inch dia. Reel (not preferred)

13 = 13 inch dia. Reel

(5) RESISTANCE VALUE

5R6, 56R, 560R, 56K, 10M.

(6) RESISTOR TERMINATIONS

L = Lead free terminations (pure Tin)

ORDERING EXAMPLE

The ordering code of a RC0402 chip resistor, value 56 Ω with $\pm 1\%$ tolerance, supplied in 7-inch tape reel is: RC0402FR-0756RL.

NOTE

1. The "L" at the end of the code is only for ordering. On the reel label, the standard CTC will be mentioned an additional stamp "LFP"= lead free production.
2. Products with lead in terminations fulfil the same requirements as mentioned in this datasheet.
3. Products with lead in terminations will be phased out in the coming months (before July 1st, 2006)

MARKING

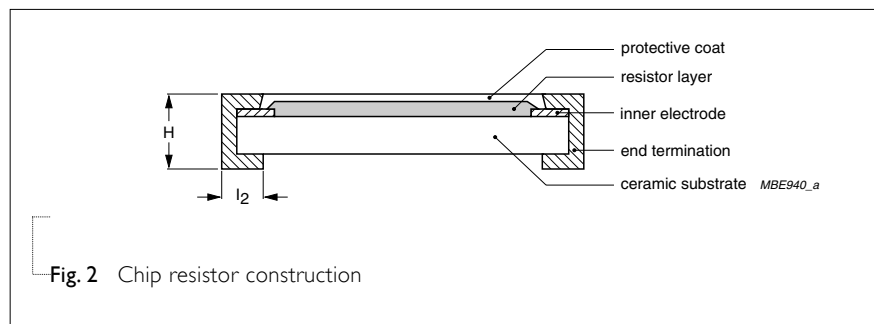
RC0402



No marking

CONSTRUCTION

The resistors are constructed out of a high-grade ceramic body. Internal metal electrodes are added at each end and connected by a resistive paste. The composition of the paste is adjusted to give the approximate required resistance and laser cutting of this resistive layer that achieves tolerance trims the value. The resistive layer is covered with a protective coat.

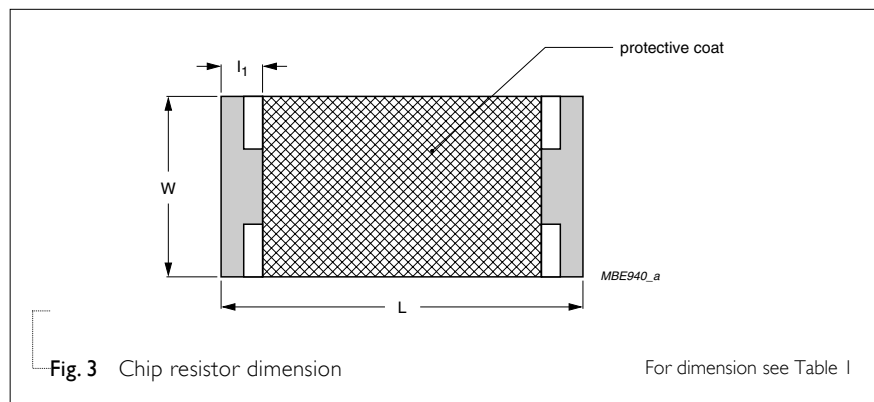


Finally, the two external terminations (pure Tin) are added. See fig. 2.

DIMENSIONS

Table I

TYPE	RC0402
L (mm)	1.00 ±0.05
W (mm)	0.50 ±0.05
H (mm)	0.35 ±0.05
l ₁ (mm)	0.20 ±0.10
l ₂ (mm)	0.25 ±0.10



Chip Resistor Surface Mount	RC	SERIES	0402 (Pb Free)
-----------------------------	----	--------	----------------

ELECTRICAL CHARACTERISTICS

Table 2

CHARACTERISTICS	RC0402 1/16 W	
Operating Temperature Range	-55 °C to +155 °C	
Maximum Working Voltage	50 V	
Maximum Overload Voltage	100 V	
Dielectric Withstanding Voltage	100 V	
Resistance Range	5% (E24) 1 Ω to 10 MΩ	
	1% (E96) 1 Ω to 10 MΩ	
	Zero Ohm Jumper < 0.05 Ω	
Temperature Coefficient	10 Ω < R ≤ 10 MΩ	±100 ppm/°C
	1 Ω < R ≤ 10 Ω	±200 ppm/°C
Jumper Criteria	Rated Current	1.0 A
	Maximum Current	2.0 A

FOOTPRINT AND SOLDERING PROFILES

For recommended footprint and soldering profiles, please see the special data sheet "Chip resistors mounting".

ENVIRONMENTAL DATA

For material declaration information (IMDS-data) of the products, please see the separated info "Environmental data".

PACKING STYLE AND PACKAGING QUANTITY

Table 3 Packing style and packaging quantity

PRODUCT TYPE	PACKING STYLE	REEL DIMENSION	QUANTITY PER REEL
RC0402	Paper / PE Taping Reel (R)	7" (178 mm)	10,000 units
		10" (254 mm) / not preferred	20,000 units
		13" (330 mm)	50,000 units

NOTE

- For Paper/PE tape and reel specification/dimensions, please see the special data sheet "Packing" document.

FUNCTIONAL DESCRIPTION**POWER RATING**

RC0402 rated power at 70°C is 1/16 W

RATED VOLTAGE

The DC or AC (rms) continuous working voltage corresponding to the rated power is determined by the following formula:

$$V = \sqrt{P \times R}$$

Where

V=Continuous rated DC or
AC (rms) working voltage (V)

P=Rated power (W)

R=Resistance value (Ω)

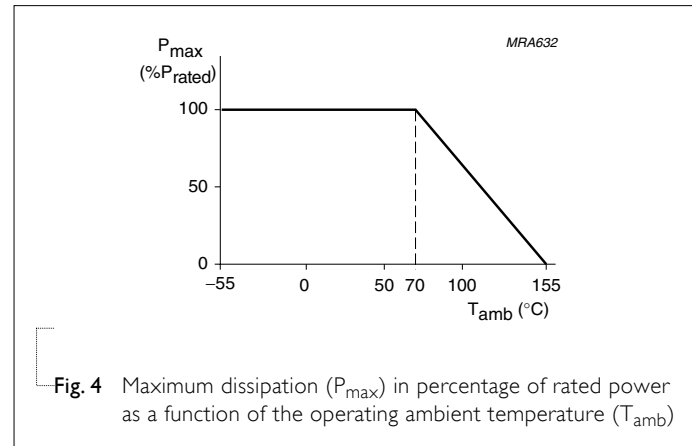
PULSE LOADING CAPABILITIES

Fig. 4 Maximum dissipation (P_{max}) in percentage of rated power as a function of the operating ambient temperature (T_{amb})

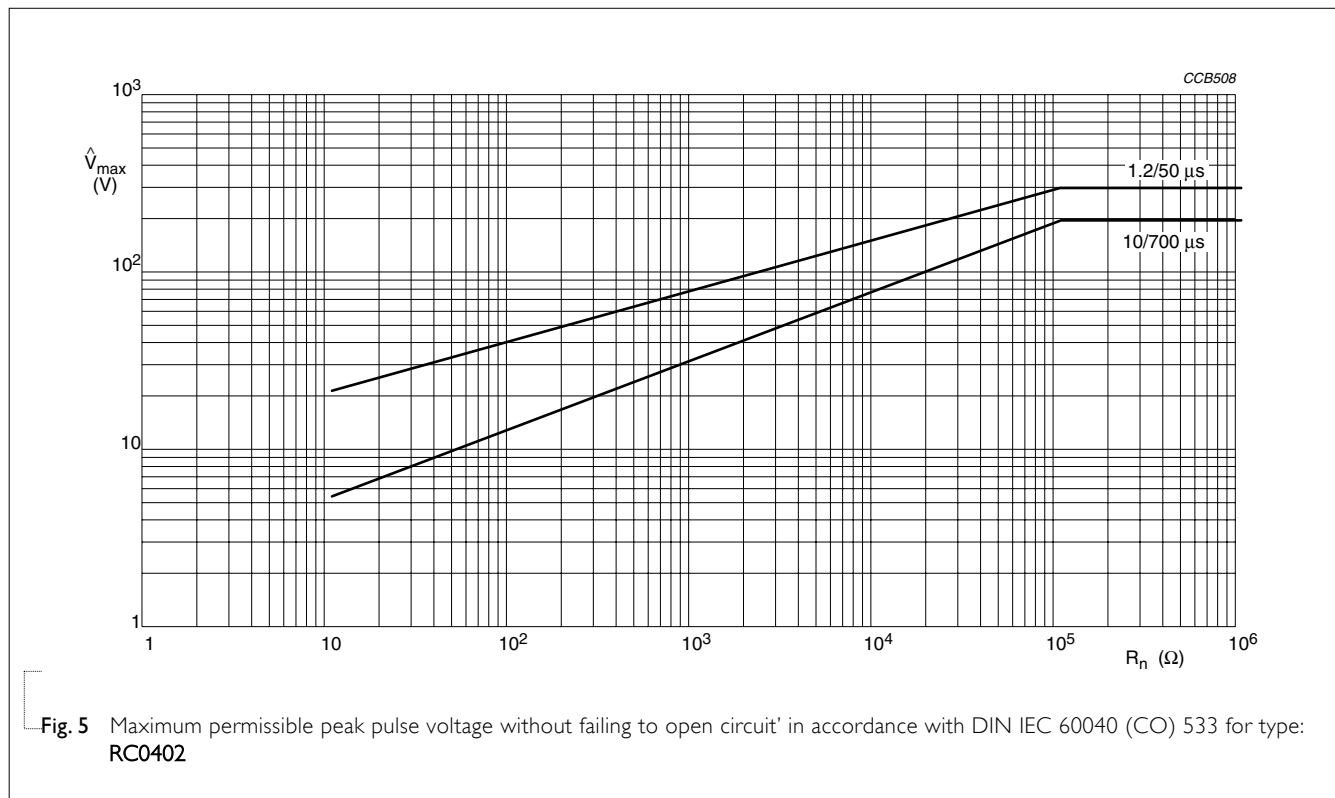
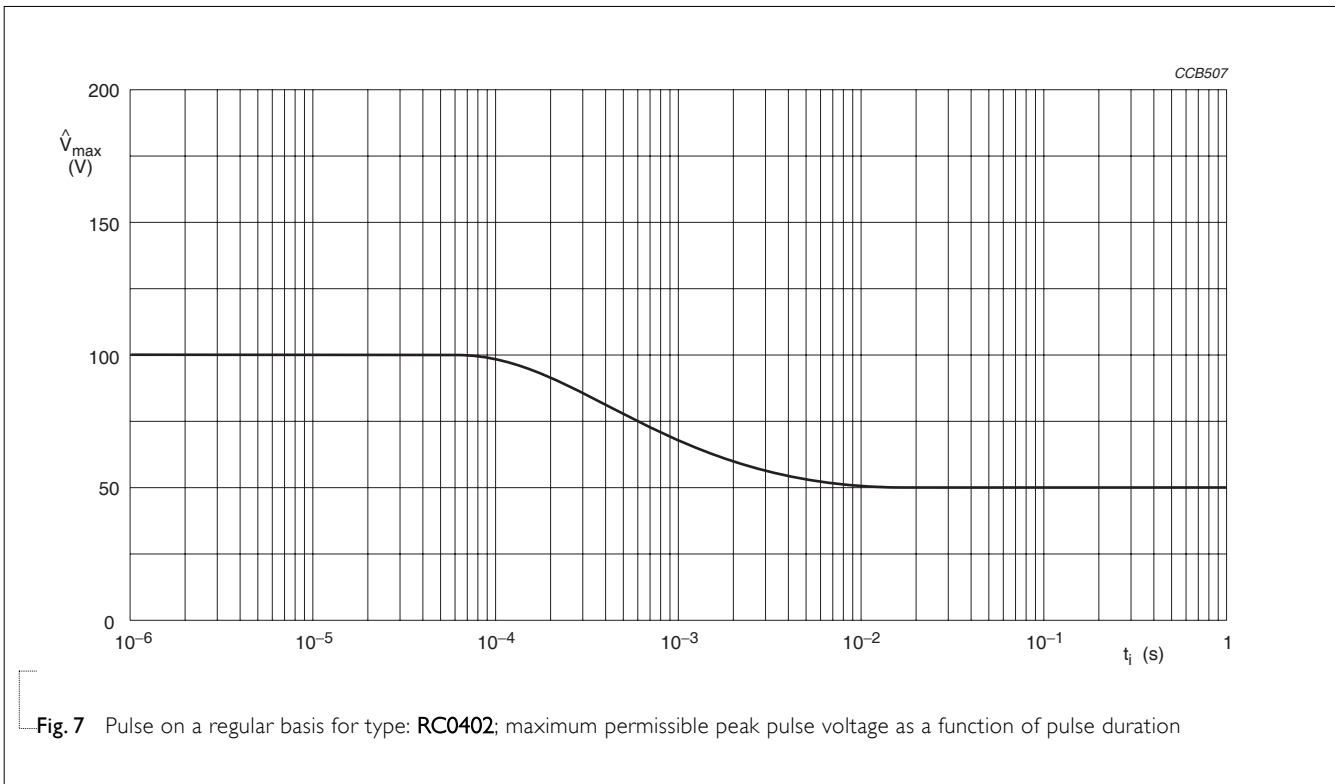
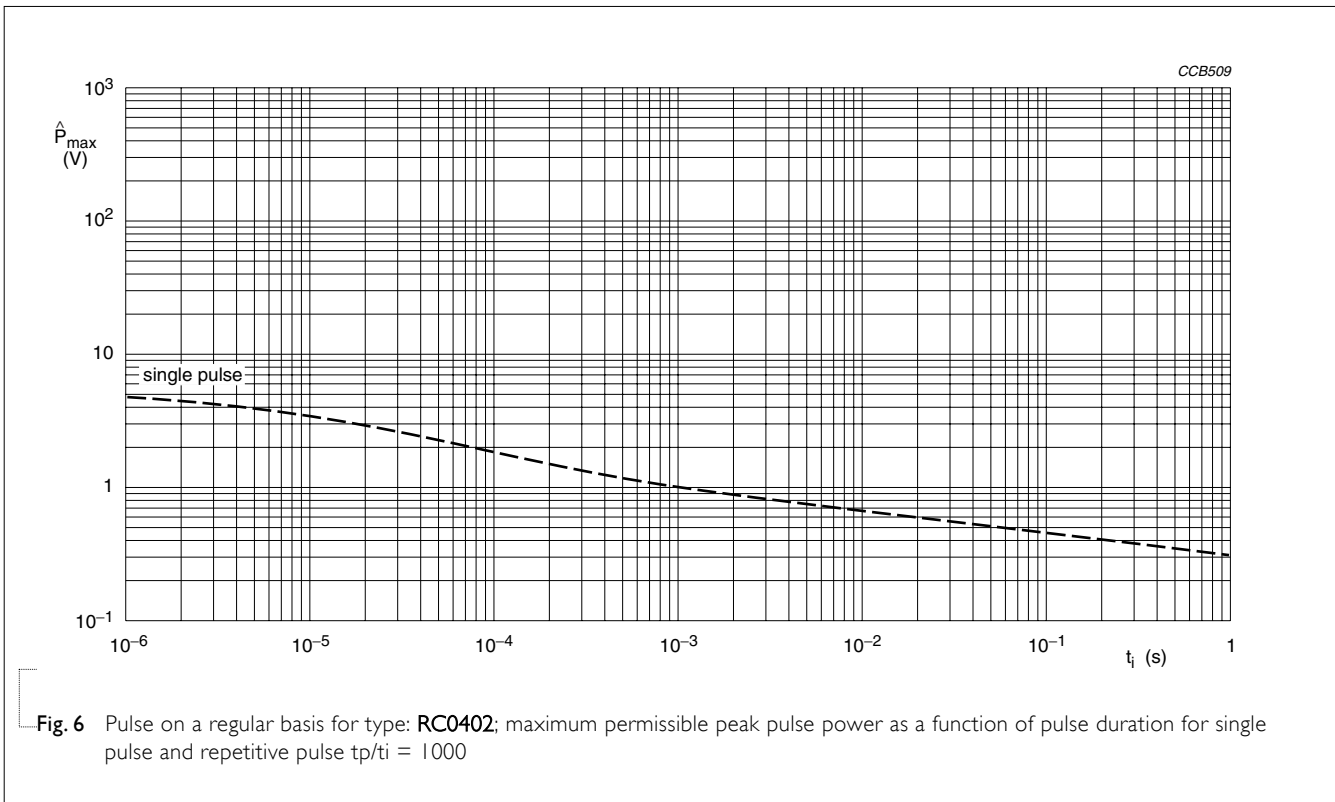


Fig. 5 Maximum permissible peak pulse voltage without failing to open circuit' in accordance with DIN IEC 60040 (CO) 533 for type: RC0402



Chip Resistor Surface Mount RC SERIES 0402 (Pb Free)

TESTS AND REQUIREMENTS

Table 4 Test condition, procedure and requirements

TEST	TEST METHOD	PROCEDURE	REQUIREMENTS
Temperature Coefficient of Resistance (T.C.R.)	MIL-STD-202F-method 304;	At +25/-55 °C and +25/+125 °C	Refer to table 2
	JIS C 5202-4.8	Formula: $T.C.R = \frac{R_2 - R_1}{R_1(t_2 - t_1)} \times 10^6 \text{ (ppm/°C)}$ Where $t_1 = +25 \text{ °C}$ or specified room temperature $t_2 = -55 \text{ °C}$ or +125 °C test temperature R_1 = resistance at reference temperature in ohms R_2 = resistance at test temperature in ohms	
Thermal Shock	MIL-STD-202F-method 107G; IEC 60115-1 4.19	At -65 (+0/-10) °C for 2 minutes and at +155 (+10/-0) °C for 2 minutes; 25 cycles	±(0.5%+0.05 Ω) for 1% tol. ±(1.0%+0.05 Ω) for 5% tol.
Low Temperature Operation	MIL-R-55342D-Para 4.7.4	At -65 (+0/-5) °C for 1 hour; RCWV applied for 45 (+5/-0) minutes	±(0.5%+0.05 Ω) for 1% tol. ±(1.0%+0.05 Ω) for 5% tol. No visible damage
Short Time Overload	MIL-R-55342D-Para 4.7.5; IEC 60115-1 4.13	2.5 × RCWV applied for 5 seconds at room temperature	±(1.0%+0.05 Ω) for 1% tol. ±(2.0%+0.05 Ω) for 5% tol. No visible damage
Insulation Resistance	MIL-STD-202F-method 302; IEC 60115-1 4.6.1.1	RCOV for 1 minute	≥10 GΩ
		Type RC0402 Voltage (DC) 100 V	
Dielectric Withstand Voltage	MIL-STD-202F-method 301; IEC 60115-1 4.6.1.1	Maximum voltage (V_{rms}) applied for 1 minute	No breakdown or flashover
		Type RC0402 Voltage (AC) 100 V_{rms}	
Resistance to Soldering Heat	MIL-STD-202F-method 210C; IEC 60115-1 4.18	Unmounted chips; 260 ±5 °C for 10 ±1 seconds	±(0.5%+0.05 Ω) for 1% tol. ±(1.0%+0.05 Ω) for 5% tol. No visible damage
Life	MIL-STD-202F-method 108A; IEC 60115-1 4.25.1	At 70±2 °C for 1,000 hours; RCWV applied for 1.5 hours on and 0.5 hour off	±(1%+0.05 Ω) for 1% tol. ±(3%+0.05 Ω) for 5% tol.

TEST	TEST METHOD	PROCEDURE	REQUIREMENTS														
Solderability	MIL-STD-202F-method 208A; IEC 60115-1 4.17	Solder bath at 245 ± 3 °C Dipping time: 2 ± 0.5 seconds	Well tinned ($\geq 95\%$ covered) No visible damage														
Bending Strength	JIS C 5202.6.14; IEC 60115-1 4.15	Resistors mounted on a 90 mm glass epoxy resin PCB (FR4) Bending: 5 mm	$\pm(1.0\%+0.05 \Omega)$ for 1% tol. $\pm(1.0\%+0.05 \Omega)$ for 5% tol. No visible damage														
Resistance to Solvent	MIL-STD-202F-method 215; IEC 60115-1 4.29	Isopropylalcohol (C_3H_7OH) or dichloromethane (CH_2Cl_2) followed by brushing	No smeared														
Noise	JIS C 5202 5.9; IEC 60115-1 4.12	Maximum voltage (V_{rms}) applied.	<table border="1"> <thead> <tr> <th>Resistors range</th> <th>Value</th> </tr> </thead> <tbody> <tr> <td>$R < 100 \Omega$</td> <td>10 dB</td> </tr> <tr> <td>$100 \Omega \leq R < 1 K\Omega$</td> <td>20 dB</td> </tr> <tr> <td>$1 K\Omega \leq R < 10 K\Omega$</td> <td>30 dB</td> </tr> <tr> <td>$10 K\Omega \leq R < 100 K\Omega$</td> <td>40 dB</td> </tr> <tr> <td>$100 K\Omega \leq R < 1 M\Omega$</td> <td>46 dB</td> </tr> <tr> <td>$1 M\Omega \leq R \leq 22 M\Omega$</td> <td>48 dB</td> </tr> </tbody> </table>	Resistors range	Value	$R < 100 \Omega$	10 dB	$100 \Omega \leq R < 1 K\Omega$	20 dB	$1 K\Omega \leq R < 10 K\Omega$	30 dB	$10 K\Omega \leq R < 100 K\Omega$	40 dB	$100 K\Omega \leq R < 1 M\Omega$	46 dB	$1 M\Omega \leq R \leq 22 M\Omega$	48 dB
Resistors range	Value																
$R < 100 \Omega$	10 dB																
$100 \Omega \leq R < 1 K\Omega$	20 dB																
$1 K\Omega \leq R < 10 K\Omega$	30 dB																
$10 K\Omega \leq R < 100 K\Omega$	40 dB																
$100 K\Omega \leq R < 1 M\Omega$	46 dB																
$1 M\Omega \leq R \leq 22 M\Omega$	48 dB																
Humidity (steady state)	JIS C 5202 7.5; IEC 60115-8 4.24.8	1,000 hours; 40 ± 2 °C; $93(+2/-3)\%$ RH RCWV applied for 1.5 hours on and 0.5 hour off	$\pm(0.5\%+0.05 \Omega)$ for 1% tol. $\pm(2.0\%+0.05 \Omega)$ for 5% tol.														
Leaching	EIA/IS 4.13B; IEC 60115-8 4.18	Solder bath at 260 ± 5 °C Dipping time: 30 ± 1 seconds	No visible damage														
Intermittent Overload	JIS C 5202 5.8	At room temperature; $2.5 \times$ RCWV applied for 1 second on and 25 seconds off; total 10,000 cycles	$\pm(1.0\%+0.05 \Omega)$ for 1% tol. $\pm(2.0\%+0.05 \Omega)$ for 5% tol.														
Resistance to Vibration	On request	On request															
Moisture Resistance Heat	MIL-STD-202F-method 106F; IEC 60115-1 4.24.2	42 cycles; total 1,000 hours Shown as Fig. 8	$\pm(0.5\%+0.05\Omega)$ for 1% tol. $\pm(2.0\%+0.05\Omega)$ for 5% tol. No visible damage														

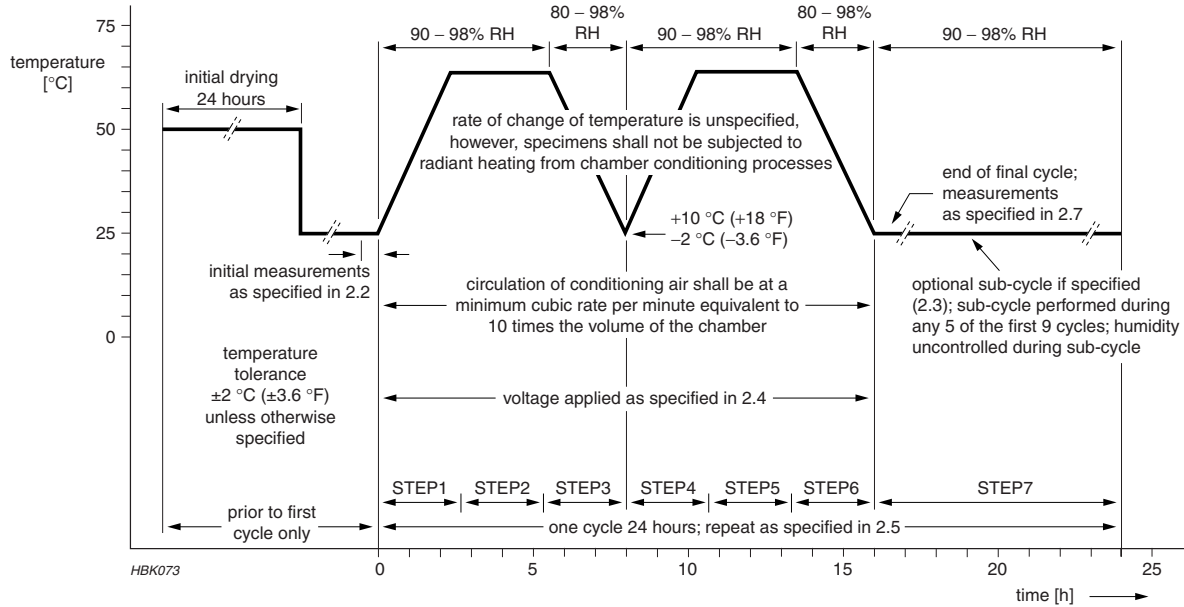


Fig. 8 Moisture resistance test requirements

Chip Resistor Surface Mount | RC | SERIES | **0402 (Pb Free)**

REVISION HISTORY

REVISION	DATE	CHANGE NOTIFICATION	DESCRIPTION
Version 2	Sep 03, 2004	-	- Test method and procedure updated - PE tape added (paper tape will be replaced by PE tape)