

PQ05RF2/21/2V Series

2A Output, Low Power-Loss Voltage Regulators

■ Features

- Low power-loss (Dropout voltage: MAX. 0.5V)
- Compact resin full-mold package.
- Built-in ON/OFF control terminal (PQ05RF2/PQ05RF21 series)
- Built-in output voltage minute adjustment terminal (ripple rejection is improved) (PQ05RF2V series)

■ Model Line-ups

Output voltage	5V Output	9V Output	12V Output	15V Output
Output voltage precision:±5%	PQ05RF2	PQ09RF2	PQ12RF2	PQ15RF2
Output voltage precision:±2.5%	PQ05RF21	PQ09RF21	PQ12RF21	PQ15RF21
Minute adjustment (Output voltage adjustment range:±10%)	PQ05RF2V	PQ09RF2V	PQ12RF2V	PQ15RF2V

■ Applications

- Series power supply for various electronic equipment such as VCRs, electronic music instruments

■ Equivalent Circuit Diagram

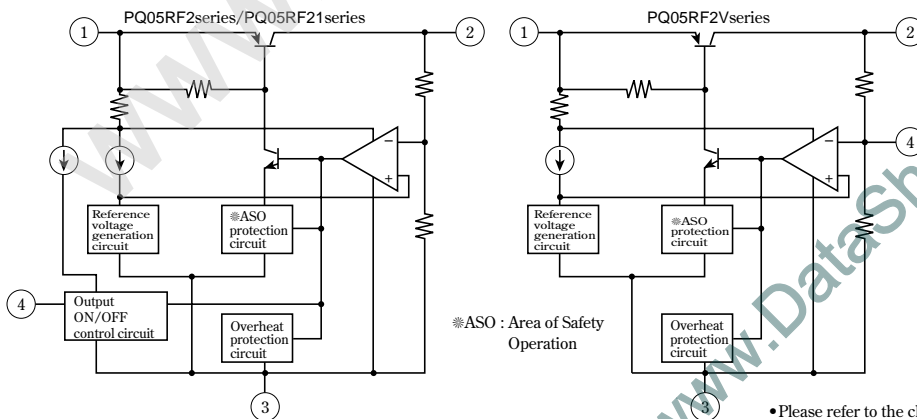

■ Outline Dimensions

(Unit : mm)

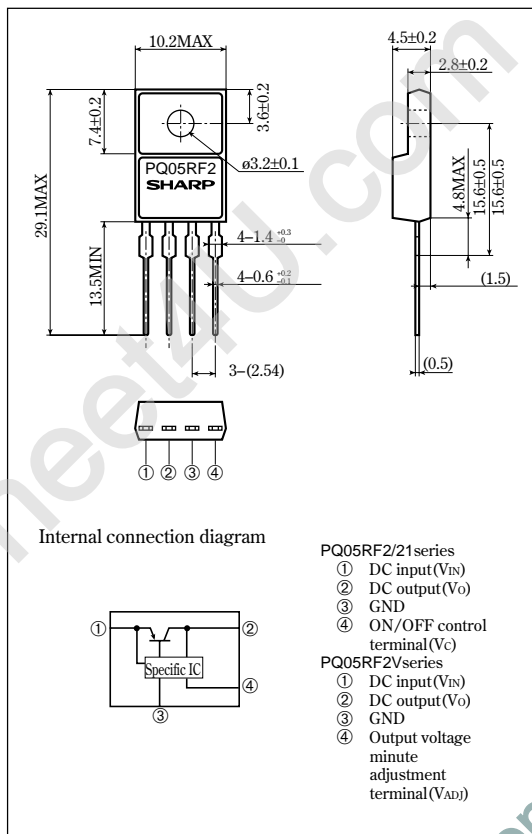

• Please refer to the chapter " Handling Precautions ".



Absolute Maximum Ratings

(T_a=25°C)

Parameter	Symbol	Rating	Unit
*1 Input voltage	V _{IN}	35	V
*1 ON/OFF control terminal voltage	PQ05RF2 series	35	V
	PQ05RF21 series		
Output current	I _o	2	A
Power dissipation (No heat sink)	P _{D1}	1.5	W
Power dissipation (With infinite heat sink)	P _{D2}	18	W
*2 Junction temperature	T _j	150	°C
Operating temperature	T _{opr}	-20 to +80	°C
Storage temperature	T _{stg}	-40 to +150	°C
Soldering temperature	T _{sol}	260 (For 10s)	°C

*1 All are open except GND and applicable terminals.

*2 Overheat protection may operate at 125<=T_j<=150°C.

Electrical Characteristics

(Unless otherwise specified, condition shall be I_o=1A, T_a=25°C, *3)

Parameter	Symbol	Conditions	MIN.	TYP.	MAX.	Unit	
Output voltage	V _o	-	PQ05RF2/PQ05RF2V	4.75	5.0	5.25	V
			PQ09RF2/PQ09RF2V	8.55	9.0	9.45	
			PQ12RF2/PQ12RF2V	11.4	12.0	12.6	
			PQ15RF2/PQ15RF2V	14.25	15.0	15.75	
			PQ05RF21	4.88	5.0	5.12	
			PQ09RF21	8.78	9.0	9.22	
			PQ12RF21	11.7	12.0	12.3	
			PQ15RF21	14.63	15.0	15.37	
Load regulation	R _{egL}	I _o =5mA to 2A	-	0.5	2.0	%	
Line regulation	R _{egI}	*4	-	0.5	2.5	%	
Temperature coefficient of output voltage	TcV _o	T _j =0 to 125°C	-	±0.02	-	%/°C	
Ripple rejection	RR	I _o =0.5A Refer to Fig.2	PQ05RF2/PQ05RF21Series	45	55	-	dB
			PQ05RF2VSeries	55	-	-	
Dropout voltage	V _{f-o}	*5, I _o =2A	-	-	0.5	V	
ON-state voltage for control	V _{C (ON)}	-	2.0 *6	-	-	V	
ON-state current for current	I _{C (ON)}	V _C =2.7V	-	-	20	µA	
OFF-state voltage for control	V _{C (OFF)}	-	-	-	0.8	V	
OFF-state current for control	I _{C (OFF)}	V _C =0.4V	-	-	-0.4	mA	
Quiescent current	I _q	I _o =0	-	-	10	mA	
Output voltage minute adjustment range	V _{o (ADJ)}	-	PQ05RF2V	4.5	5.0	5.5	V
			PQ09RF2V	8.1	9.0	9.9	
			PQ12RF2V	10.8	12.0	13.2	
			PQ15RF2V	13.5	15.0	16.5	

*3 PQ05RF2 Series: V_{IN}=7V, PQ09RF2 Series: V_{IN}=15V, PQ12RF2 Series: V_{IN}=18V, PQ15RF2 Series: V_{IN}=23V

*4 PQ05RF2/PQ05RF21/PQ05RF2V: V_{IN}=6 to 12V PQ09RF2/PQ09RF21/PQ09RF2V: V_{IN}=10 to 25V

PQ12RF2/PQ12RF21/PQ12RF2V: V_{IN}=13 to 29V PQ15RF2/PQ15RF21/PQ15RF2V: V_{IN}=16 to 32V

*5 Input voltage shall be the value when output voltage is 95% in comparison with the initial value.

*6 In case of opening control terminal @, output voltage turns on. (PQ05RF2/PQ05RF21 Series)

Fig. 1 Test Circuit

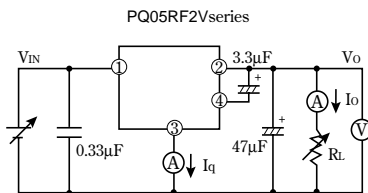
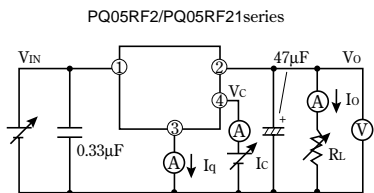

Fig. 2 Test Circuit of Ripple Rejection

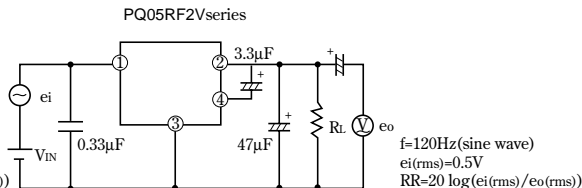
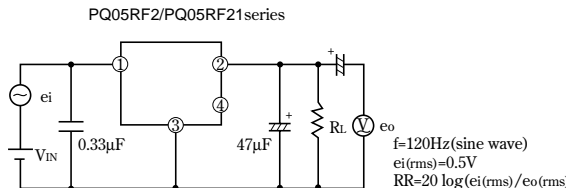
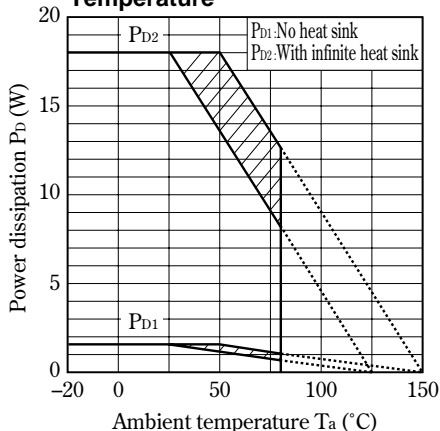

Fig. 3 Power Dissipation vs. Ambient Temperature



Note) Oblique line portion : Overheat protection may operate in this area.

Fig. 4 Overcurrent Protection Characteristics (Typical value)

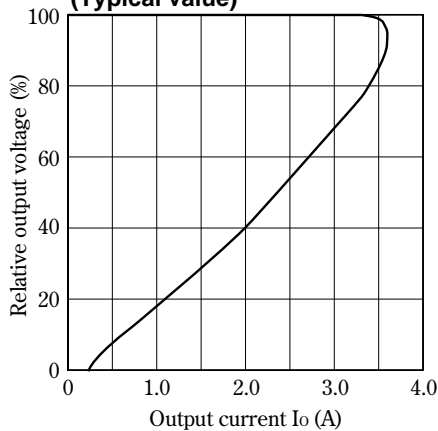

Fig. 5 Output Voltage Minute Adjustment Characteristics (PQ05RF2V)

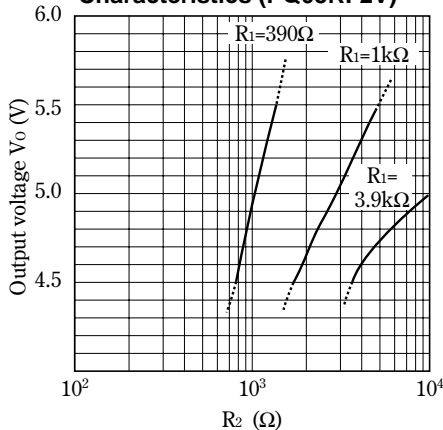

Fig. 6 Output Voltage Minute Adjustment Characteristics (PQ09RF2V)

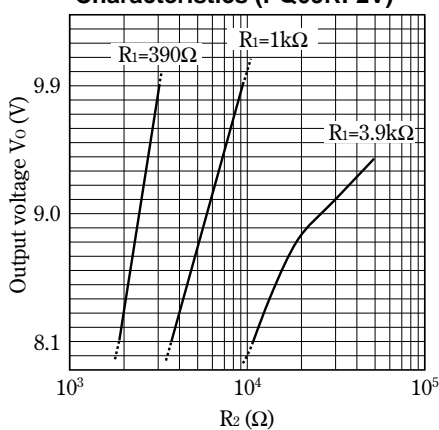

Fig. 7 Output Voltage Minute Adjustment Characteristics (PQ12RF2V)

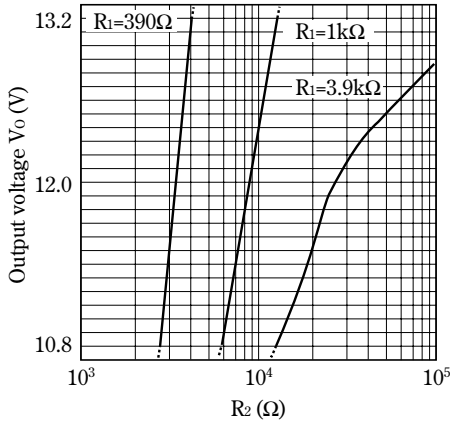

Fig. 8 Output Voltage Minute Adjustment Characteristics (PQ15RF2V)

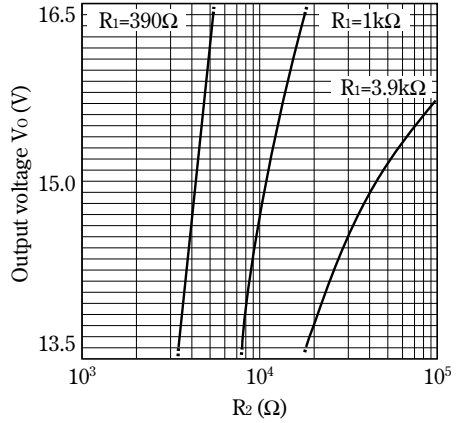

Fig. 9 Output Voltage Deviation vs. Junction Temperature (PQ05RF2/PQ05RF21/PQ05RF2V)

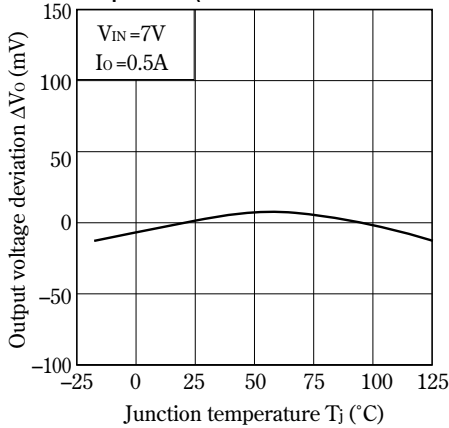

Fig.10 Output Voltage Deviation vs. Junction Temperature (PQ09RF2/PQ09RF21/PQ09RF2V)

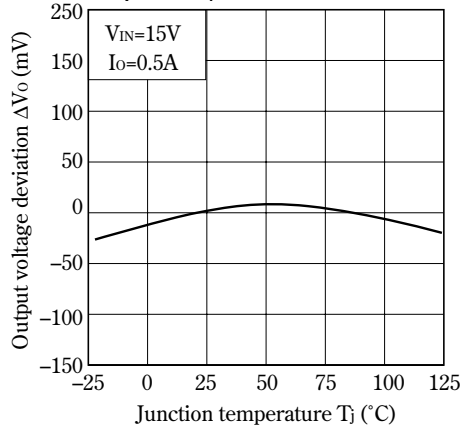

Fig.11 Output Voltage Deviation vs. Junction Temperature (PQ12RF2/PQ12RF21/PQ12RF2V)

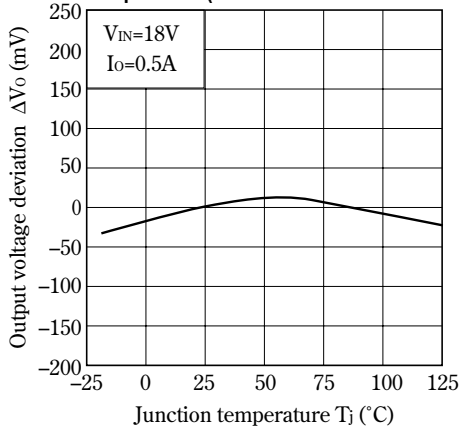

Fig.12 Output Voltage Deviation vs. Junction Temperature (PQ15RF2/PQ15RF21/PQ15RF2V)

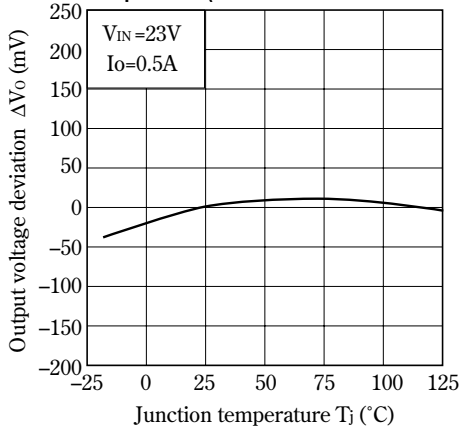

Fig.13 Output Voltage vs. Input Voltage (PQ05RF2/PQ05RF21/PQ05RF2V)

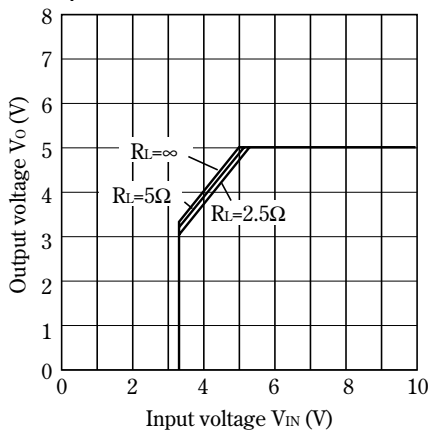

Fig.14 Output Voltage vs. Input Voltage (PQ09RF2/PQ09RF21/PQ09RF2V)

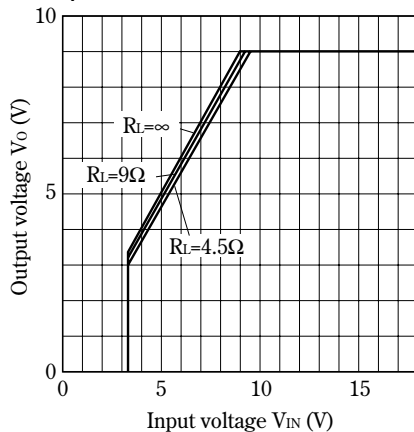

Fig.15 Output Voltage vs. Input Voltage (PQ12RF2/PQ12RF21/PQ12RF2V)

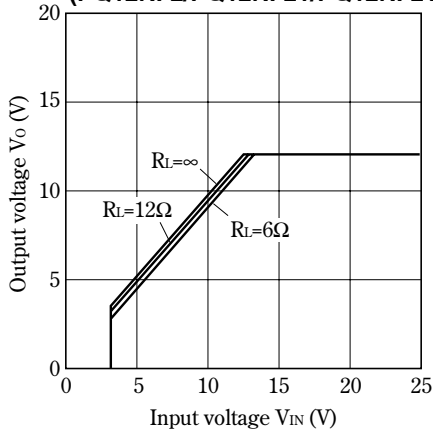

Fig.16 Output Voltage vs. Input Voltage (PQ15RF2/PQ15RF21/PQ15RF2V)

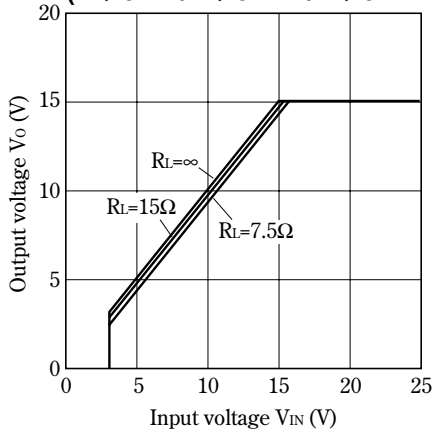

Fig.17 Circuit Operating Current vs. Input Voltage (PQ05RF2/PQ05RF21/PQ05RF2V)

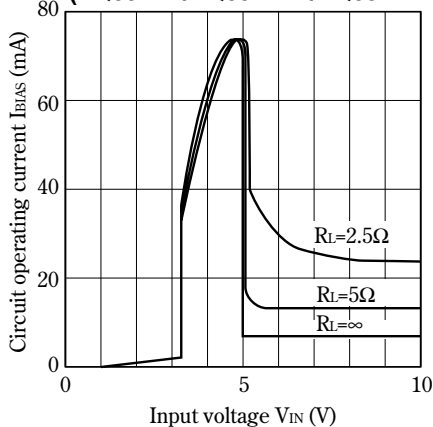

Fig.18 Circuit Operating Current vs. Input Voltage (PQ09RF2/PQ09RF21/PQ09RF2V)

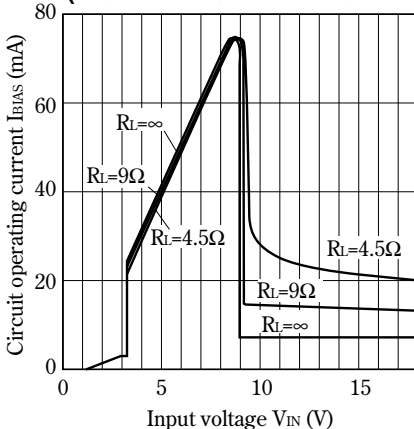

Fig.19 Circuit Operating Current vs. Input Voltage (PQ12RF2/PQ12RF21/PQ12RF2V)

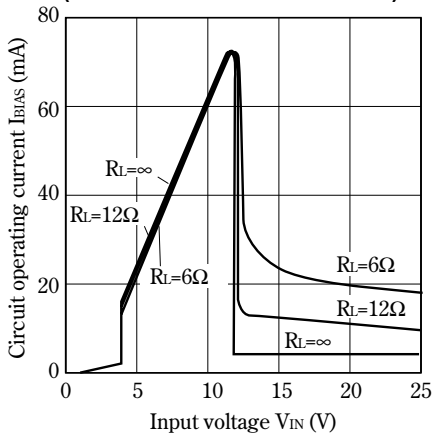

Fig.20 Circuit Operating Current vs. Input Voltage (PQ15RF2/PQ15RF21/PQ15RF2V)

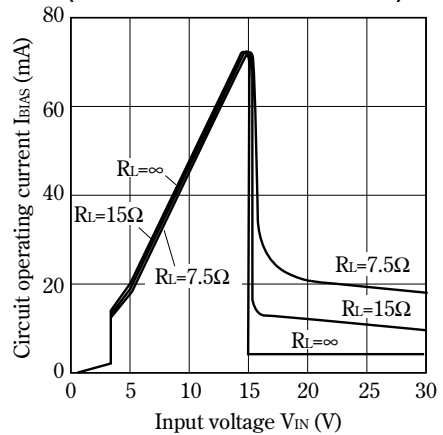

Fig.21 Dropout Voltage vs. Junction Temperature

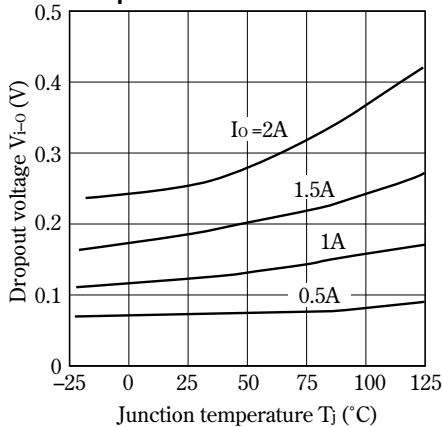

Fig.22 Quiescent Current vs. Junction Temperature

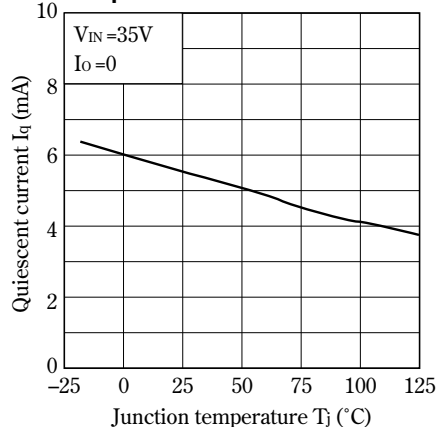

Fig.23 Ripple Rejection vs. Input Ripple Frequency (PQ05RF2/PQ05RF21/PQ09RF2/PQ09RF21/PQ12RF2/PQ12RF21/PQ15RF2/PQ15RF21)

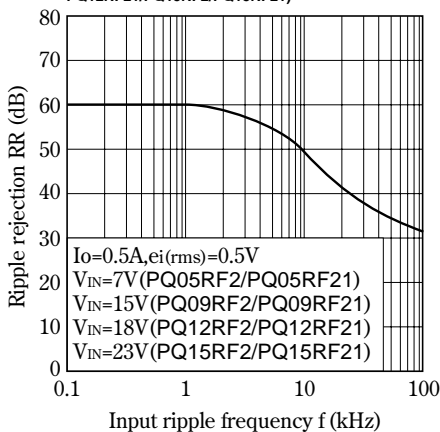

Fig.24 Ripple Rejection vs. Input Ripple Frequency (PQ05RF2V/PQ09RF2V/PQ12RF2V/PQ15RF2V)

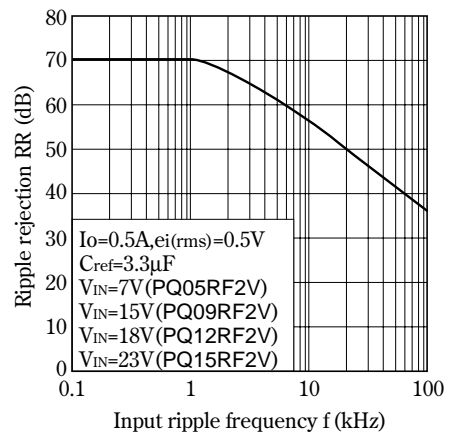
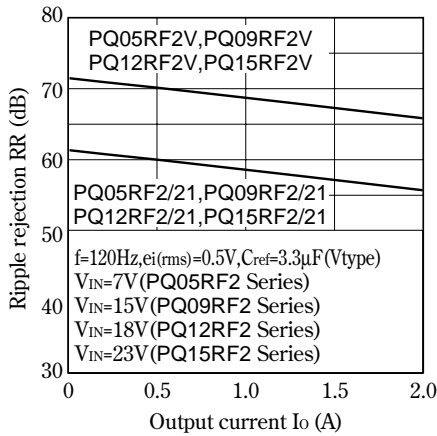
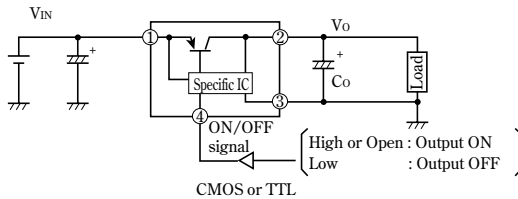

Fig.25 Ripple Rejection vs. Output Current



■ Typical Application

PQ05RF2/PQ05RF21 Series



PQ05RF2V Series

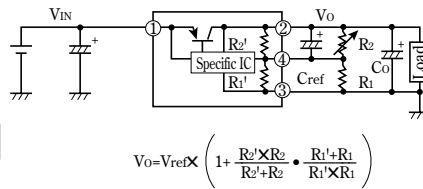

V_{ref} Nearly=1.26V, R_1' Nearly=390Ω
 PQ05RF2V : R_2' Nearly=1.16kΩ
 PQ09RF2V : R_2' Nearly=2.40kΩ
 PQ12RF2V : R_2' Nearly=3.32kΩ
 PQ15RF2V : R_2' Nearly=4.45kΩ

(Note) R_1' and R_2' are built in a specific IC.

■ Model Line-ups for Lead Forming Type

Output voltage	5V Output	9V Output	12V Output	15V Output
Output voltage precision:±5%	PQ05RF2A	PQ09RF2A	PQ12RF2A	PQ15RF2A
Output voltage precision:±2.5%	PQ05RF2B	PQ09RF2B	PQ12RF2B	PQ15RF2B

Outline Dimensions (PQ05RF2A/PQ05RF2B Series)

(Unit : mm)

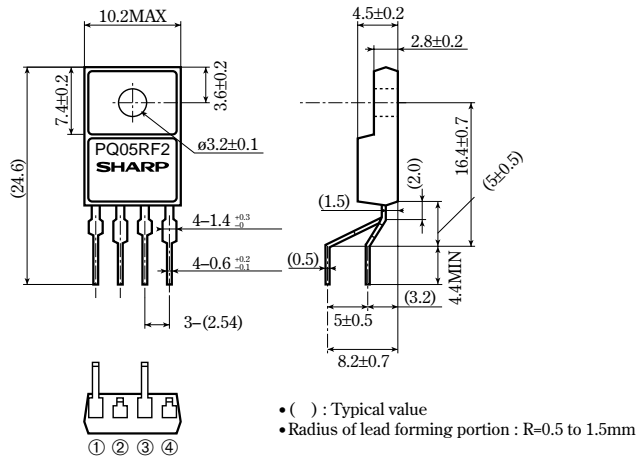

Internal connection diagram

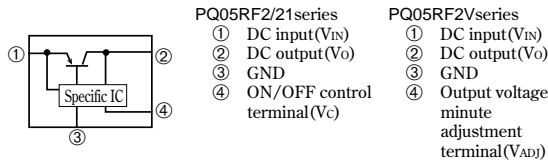

Note) The value of absolute maximum ratings and electrical characteristics is same as ones of PQ05RF2/21series.

Precautions for Use

(1) Minute adjustment of output voltage (PQ05RF2V series)

If the external resistor is attached to the terminals ②, ③ and ④, minute adjustment of output voltage is possible. (Refer to the example of basic circuit (PQ05RF2V series) and Fig.5 to 8.)