

**PLEASE CHECK WWW.MOLEX.COM FOR LATEST PART INFORMATION**

**Part Number:** [5015714007](#)  
**Status:** **Active**  
**Overview:** [picoclasp](#)  
**Description:** 1.00mm (.039") Pitch Pico-Clasp™ Wire-to-Board PCB Header, Dual Row, Right Angle, 40 Circuits, Lead-free

**Documents:**

[3D Model](#) [Product Specification PS-501571-001 \(PDF\)](#)  
[Drawing \(PDF\)](#) [RoHS Certificate of Compliance \(PDF\)](#)

**General**

Product Family	PCB Headers
Series	<a href="#">501571</a>
Application	Wire-to-Board
Overview	<a href="#">picoclasp</a>
Product Name	Pico-Clasp™

**Physical**

Breakaway	No
Circuits (Loaded)	40
Circuits (maximum)	40
Color - Resin	Natural
Durability (mating cycles max)	30
First Mate / Last Break	No
Glow-Wire Compliant	No
Guide to Mating Part	No
Keying to Mating Part	None
Lock to Mating Part	Yes
Material - Metal	Brass, Phosphor Bronze
Material - Plating Mating	Gold
Material - Plating Termination	Gold
Material - Resin	High Temperature Thermoplastic
Number of Rows	2
Orientation	Right Angle
PC Tail Length (in)	0.000 In
PC Tail Length (mm)	0.00 mm
PCB Locator	No
PCB Retention	Yes
PCB Thickness Recommended (in)	0.000 In
PCB Thickness Recommended (mm)	0.00 mm
Packaging Type	Embossed Tape on Reel
Pitch - Mating Interface (in)	0.039 In
Pitch - Mating Interface (mm)	1.00 mm
Pitch - Term. Interface (in)	0.039 In
Pitch - Term. Interface (mm)	1.00 mm
Plating min: Mating (µin)	4
Plating min: Mating (µm)	0.1
Plating min: Termination (µin)	4
Plating min: Termination (µm)	0.1
Polarized to Mating Part	Yes
Polarized to PCB	Yes
Shrouded	Yes
Stackable	No
Surface Mount Compatible (SMC)	Yes
Temperature Range - Operating	-40°C to +85°C
Termination Interface: Style	Surface Mount

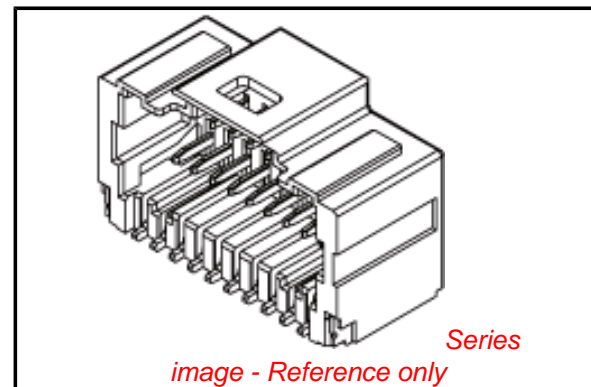

**EU RoHS**

**ELV and RoHS  
Compliant**  
**REACH SVHC**  
 Not Reviewed  
**Halogen-Free**  
**Status**  
**Not Reviewed**

**China RoHS**



**Need more information on product  
environmental compliance?**

Email [productcompliance@molex.com](mailto:productcompliance@molex.com)  
 For a multiple part number RoHS Certificate of Compliance, [click here](#)

Please visit the [Contact Us](#) section for any non-product compliance questions.

**Search Parts in this Series**

[501571Series](#)

**Mates With**

[501189](#) Pico-Clasp™ Wire-to-Board Female Housing

**Electrical**

Current - Maximum per Contact

0.8A, 1A

Voltage - Maximum

50V AC (RMS)/DC

**Material Info****Reference - Drawing Numbers**

Packaging Specification

SPK-501571-001

Product Specification

PS-501571-001, RPS-501190-003, RPS-501190-008,

RPS-501331-001, RPS-501571-005, RPS-501571-006,

RPS-501571-007, RPS-501571-008

Sales Drawing

SD-501571-001, SD-501571-002

This document was generated on 05/26/2010

**PLEASE CHECK [WWW.MOLEX.COM](http://WWW.MOLEX.COM) FOR LATEST PART INFORMATION**

10 9 8 7 6 5 4 3 2 1

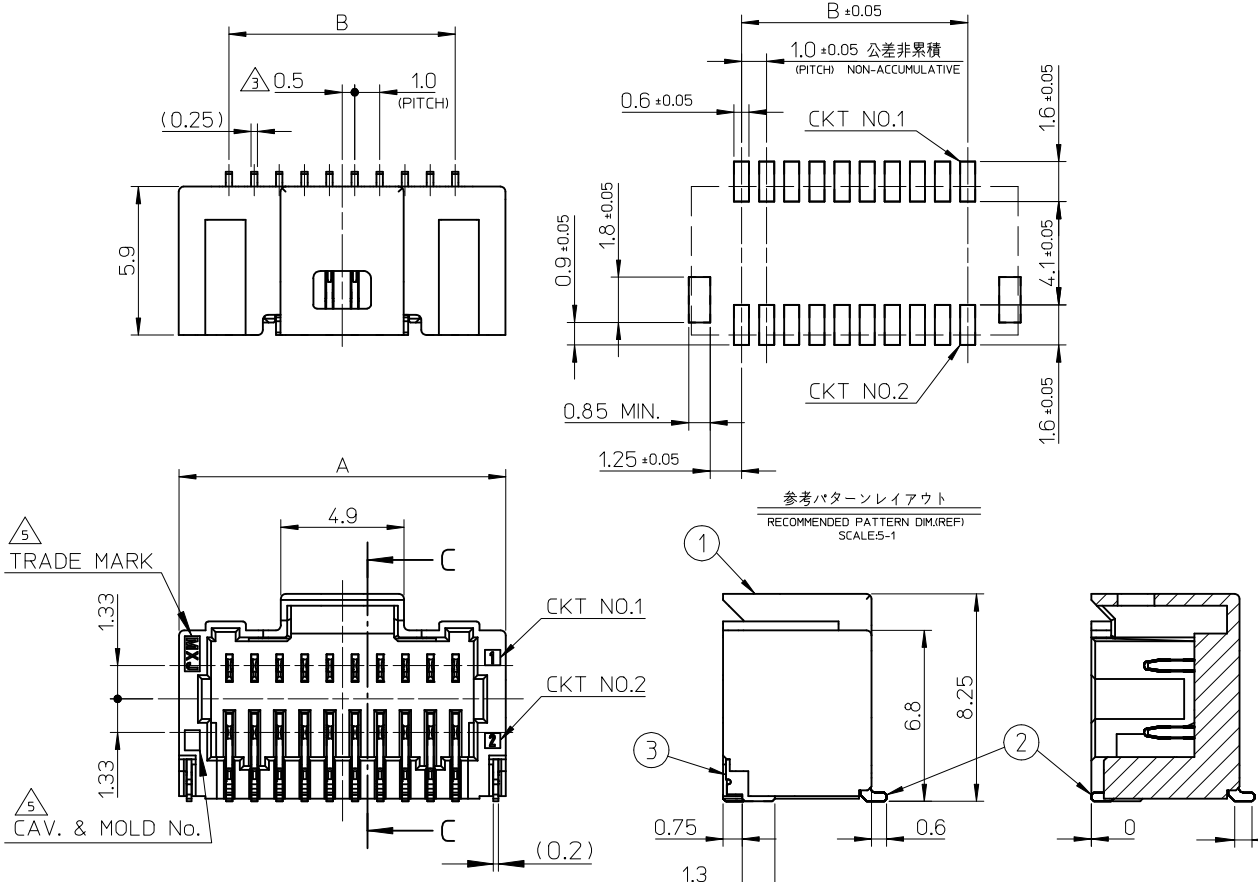

NOTES

1. 嵌合相手: 501189-\*\*\*\*  
MATE WITH: 501189-\*\*\*\*
2. ソルダピン及びネールの平坦度は0.1MAX.  
SOLDER PIN AND NAIL COPLANRITY TO BE 0.1MAX.
3.  $\triangle$  極数/2=偶数極の場合に適用  
APPLY FOR (CIRCUIT/2=EVEN)
4. 製品番号  
MATERIAL No.  
501571 - \*\*07  
極数  
CIRCUIT SIZE
5.  $\triangle$  トレードマーク: MXプラス1文字のアルファベットにて構成  
但し"J"はJAPANを示す。(例 MXJ)  
キャビティ番号: 1桁から2桁の数字にて構成  
金型番号: アルファベット1文字にて構成  
TRADE MARK: FORMED BY MX AND 1 MORE  
LETTER OF ALPHABET, BUT "J" MEANS JAPAN. (e.g. MXJ)  
CAVITY No.: FORMED BY 1 - 2 DIGIT NUMBERS.  
MOLD No.: FORMED BY 1 LETTER OF ALPHABET.

SECTION C-C

番号 NO.	部品 PART	材質 MATERIAL
①	ウエハー WAFER	耐熱ナイロン、UL94V-0、色: 自然色 HEAT RESISTANCE NYLON, UL94V-0, COLOR:NATURAL
②	ソルダーピン SOLDER PIN	リン青銅 PHOSPHOR BRONZE 金メッキ : 0.1 MICRO METER MINIMUM. GOLD PLATING ニッケル下地メッキ : 1 MICRO METER MINIMUM. NICKEL UNDER PLATING
③	ネイル NAIL	黄銅 BRASS すずメッキ : 1 MICRO METER MINIMUM. TIN PLATING ニッケル下地メッキ : 1 MICRO METER MINIMUM. NICKEL UNDER PLATING

24	28	501571-5007	50
19	23	501571-4007	40
14	18	501571-3007	30
9	13	501571-2007	20
B	A	(EMBOSSED) PACKAGE オーダー番号 ORDER NO.	CKT
CONNECTOR SERIES No. 501571-**09			

REVISED EC NO: J2010-0354 DRWNS:KUROSE 2009/08/31 CHKD:KASAKAWA 2009/08/31 APPR:NUKITA 2009/08/31	DESCRIPTION	GENERAL TOLERANCES (UNLESS SPECIFIED)	DIMENSION STYLE MM ONLY	SCALE 5:1	DESIGN UNITS METRIC	THIRD ANGLE PROJECTION	
	REV	10 UNDER ±0.2	DRAWN BY TRSUZUKI	DATE 2005/02/14	TITLE 1.0 WIRE TO BOARD CONN. 2-ROW R/A WAFER ASSY -LEAD FREE-	MOLEX INCORPORATED	
		10 OVER 30 UNDER ±0.25	CHECKED BY MYAGI	DATE 2005/02/14	APPROVED BY ANODA		DATE 2005/02/14
		30 OVER ±0.3	ANGULAR ±3 °	APPROVED BY ANODA	DATE 2005/02/14	MATERIAL NO. SEE TABLE	DOCUMENT NO. SD-501571-001
		DRAFT WHERE APPLICABLE MUST REMAIN WITHIN DIMENSIONS	SIZE A3	THIS DRAWING CONTAINS INFORMATION THAT IS PROPRIETARY TO MOLEX INCORPORATED AND SHOULD NOT BE USED WITHOUT WRITTEN PERMISSION			SHEET NO. 1 OF 1

F

E

D

C

B

A

F

E

D

C

B

A

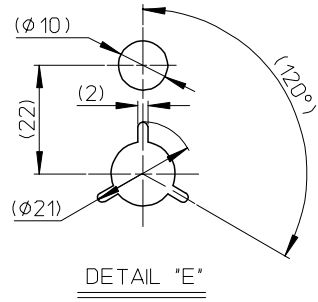
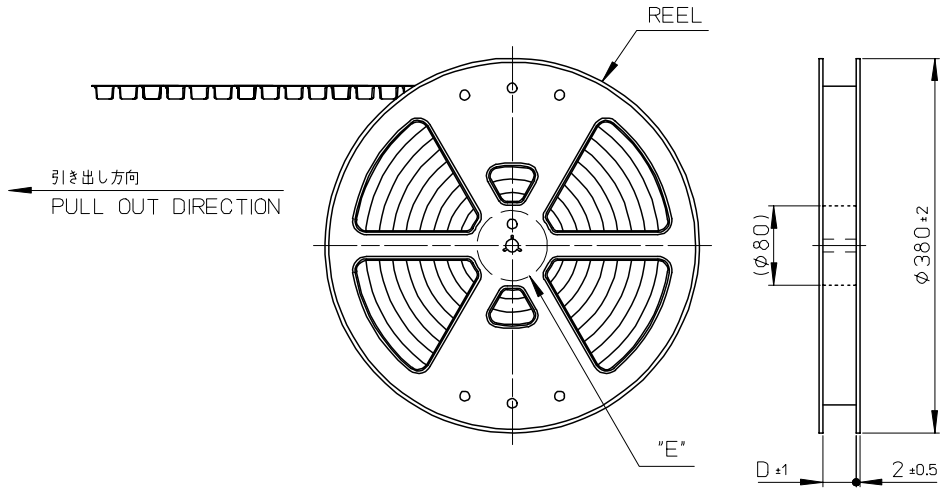

NOTES

- 製品詳細寸法については SD-501571-001 を参照ください。  
RE DETAILED DIMENSION, SEE SD-501571-001
- 梱包数量： 800 個/リール  
NUMBER OF CONNECTORS： 800 PIECES/REEL
- リードテープ長さ  
LEAD TAPE LENGTH

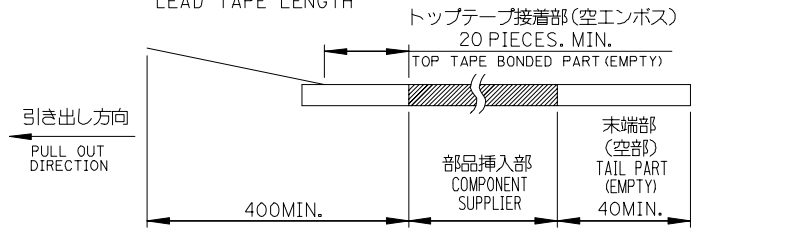

- トップテープの剥離強度： 0.1~1.3N (10.2 ~ 132.5gf) (剥離方向は下図参照)  
PEELING OFF FORCE OF TOP TAPE (PEELING DIRECTION AS SHOWN IN FOLLOWING FIGURE)  
尚、本規格値は、出荷時に適用。(但し、輸送時に剥離が発生しないこと)  
THIS REQUIREMENT SHOULD BE APPLIED AT SHIPMENT.  
PEEL OFF SHOULD NOT BE ALLOWED, DURING TRANSPORTATION.

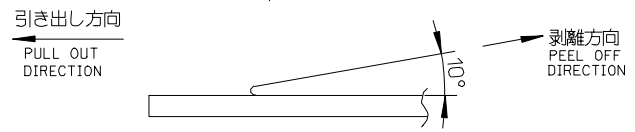

- 材料  
MATERIAL  
キャリアテープ：ポリプロピレン  
CARRIER TAPE: POLYPROPYLENE  
トップテープ：PET, PE, REF  
TOP TAPE  
リール：ポリスチレン (リサイクル材を含む)  
REEL: POLYSTYRENE (RECYCLE MATERIAL CONTAINED)

RELEASED EC NO: J2005-2381 DRAWN: TRSUZUKI CHKD: MYAGI APPR: ANODA 2005/02/15 2005/02/15 2005/02/24	GENERAL TOLERANCES (UNLESS SPECIFIED)		DIMENSION STYLE MM ONLY		SCALE ---	DESIGN UNITS METRIC	THIRD ANGLE PROJECTION	
	10 UNDER	±0.2	DRAWN BY TRSUZUKI		DATE 2005/02/14	TITLE 1.0 WIRE TO BOARD CONN. 2-ROW R/A WAFER ASSY EMBTP PKG -LEAD FREE-		
	10 OVER 30 UNDER	±0.25	CHECKED BY MYAGI		DATE 2005/02/14	MOLEX INCORPORATED		
	30 OVER	±0.3	APPROVED BY ANODA		DATE 2005/02/14	DOCUMENT NO. SD-501571-002		
	ANGULAR	±3 °	MATERIAL NO. SEE SHEET 2		SHEET NO. 1 OF 2		SHEET NO. 1 OF 2	
DRAFT WHERE APPLICABLE MUST REMAIN WITHIN DIMENSIONS		SIZE A3 THIS DRAWING CONTAINS INFORMATION THAT IS PROPRIETARY TO MOLEX INCORPORATED AND SHOULD NOT BE USED WITHOUT WRITTEN PERMISSION						

10 9 8 7 6 5 4 3 2 1

F

E

D

C

B

A

引き出し方向  
PULL OUT DIRECTION

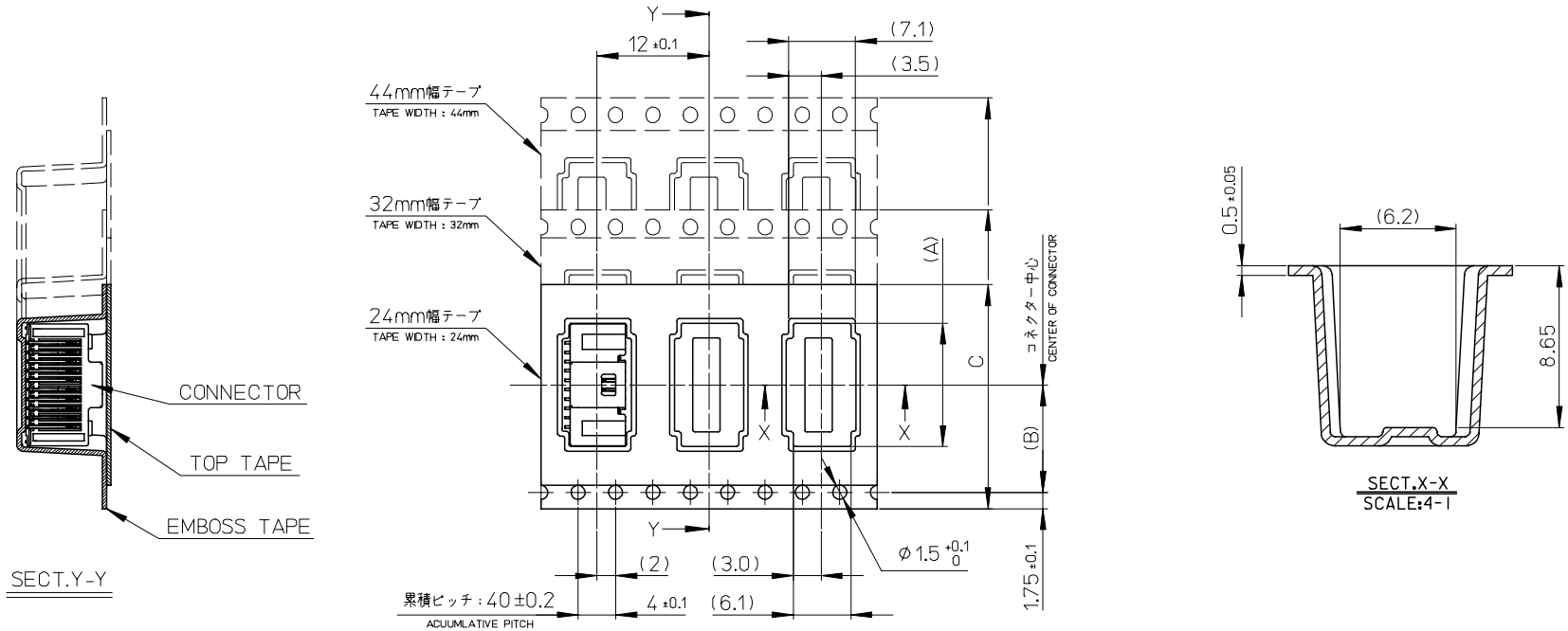

45.5	44±0.3	20.2	28.3	501571-5009	501571-5007	50
			23.3	501571-4009	501571-4007	40
33.5	32±0.3	14.2	18.3	501571-3009	501571-3007	30
25.5	24±0.3	11.5	13.3	501571-2009	501571-2007	20
D	C	(B)	(A)	CONNECTOR	MATERIAL NO.	CKTS.

RELEASED EC NO: J2005-2381 DRAWN: TRSUZUKI CHKD: MYAGI APPR: ANODA 2005/02/15 2005/02/15 2005/02/24	GENERAL TOLERANCES (UNLESS SPECIFIED)		DIMENSION STYLE MM ONLY		SCALE ---	DESIGN UNITS METRIC	THIRD ANGLE PROJECTION
	10 UNDER	±0.2	DRAWN BY TRSUZUKI	DATE 2005/02/14	TITLE 1.0 WIRE TO BOARD CONN. 2-ROW R/A WAFER ASSY EMBTP PKG -LEAD FREE-		
	10 OVER 30 UNDER	±0.25	CHECKED BY MYAGI	DATE 2005/02/14	MOLEX INCORPORATED		
	30 OVER	±0.3	APPROVED BY ANODA	DATE 2005/02/14	DOCUMENT NO. SD-501571-002		
	ANGULAR ±3°		MATERIAL NO.	SEE CHART	SHEET NO. 2 OF 2		
DRAFT WHERE APPLICABLE MUST REMAIN WITHIN DIMENSIONS		SIZE A3	THIS DRAWING CONTAINS INFORMATION THAT IS PROPRIETARY TO MOLEX INCORPORATED AND SHOULD NOT BE USED WITHOUT WRITTEN PERMISSION				

9

8

7

6

5

4

3

2