

HLMP-HB55/HLMP-HM55/ HLMP-HB54/HLMP-HM54

5 mm Precision Optical Performance
InGaN Oval LED Lamps

Data Sheet



Description

These Precision Optical Performance Oval LEDs are specifically designed for full color/video and passenger information signs. The oval shaped radiation pattern and high luminous intensity ensure that this device is excellent for wide field of view outdoor applications where a wide viewing angle and readability in sunlight are essential. This lamp has very smooth, matched radiation patterns ensuring consistent color mixing in full color applications, message uniformity across the viewing angle of the sign. High efficiency LED material is used in this lamp: Indium Gallium Nitride for Blue and Green. Each lamp is made with an advanced optical grade epoxy offering superior high temperature and high moisture resistance in outdoor applications. The package epoxy contains both UV-a and UV-b inhibitors to reduce the effects of long term exposure to direct sunlight. These lamps are available in two package options (standoff and without standoff) to give designer flexibility with device mounting.

Features

- Well-defined spatial radiation pattern
- High brightness material
 - Blue InGaN 470 nm
 - Green InGaN 525 nm

Applications

- Full color signs
- Commercial outdoor advertising

Benefits

- Viewing angle designed for wide field of view applications
- Superior performance for outdoor environments

CAUTION: InGaN devices are Class 1C HBM ESD sensitive per JEDEC standard. Please observe appropriate precautions during handling and processing. Refer to Application Note AN-1142 for additional details.

Package Dimensions

Package Drawing A

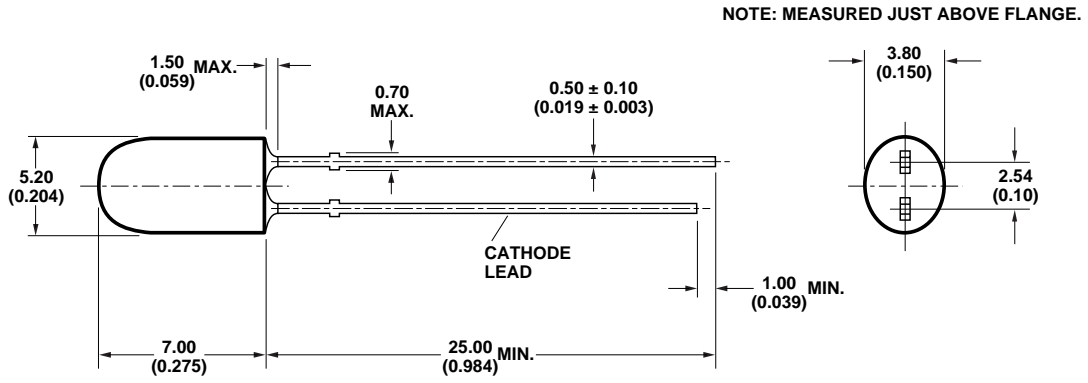

- NOTES:
1. DIMENSIONS IN MILLIMETERS (INCHES).
2. TOLERANCE ± 0.25 mm UNLESS OTHERWISE NOTED.

Package Drawing B

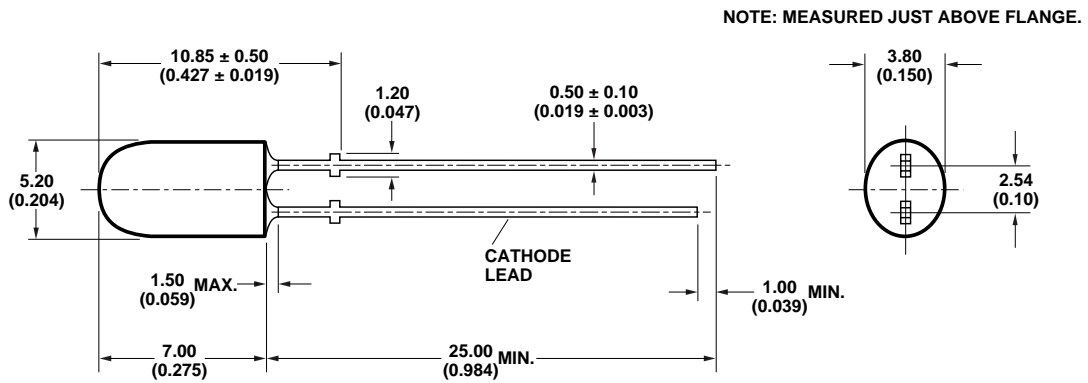

- NOTES:
1. DIMENSIONS IN MILLIMETERS (INCHES).
2. TOLERANCE ± 0.25 mm UNLESS OTHERWISE NOTED.

Device Selection Guide

Part Number	Color and Dominant Wavelength λ_d (nm) Typ.	Luminous Intensity Iv (mcd) at 20 mA Min.	Luminous Intensity Iv (mcd) at 20 mA Max.	Leads with Standoff	Package Drawing	Tinting Type
HLMP-HB54-FJ0xx	Blue 470	110	310	No	A	Blue
HLMP-HB55-HJCxx	Blue 470	180	310	Yes	B	Blue
HLMP-HB55-JKCxx	Blue 470	240	400	Yes	B	Blue
HLMP-HM54-MQ0xx	Green 525	520	1500	No	A	Green
HLMP-HM55-MQ0xx	Green 525	520	1500	Yes	B	Green
HLMP-HM55-NPCxx	Green 525	680	1150	Yes	B	Green
HLMP-HM55-PQCxx	Green 525	880	1500	Yes	B	Green

Notes:

1. The luminous intensity is measured on the mechanical axis of the lamp package.
2. The optical axis is closely aligned with the package mechanical axis.
3. The dominant wavelength, λ_d , is derived from the Chromaticity Diagram and represents the color of the lamp.

Part Numbering System

HLMP-X X XX - X X X XX

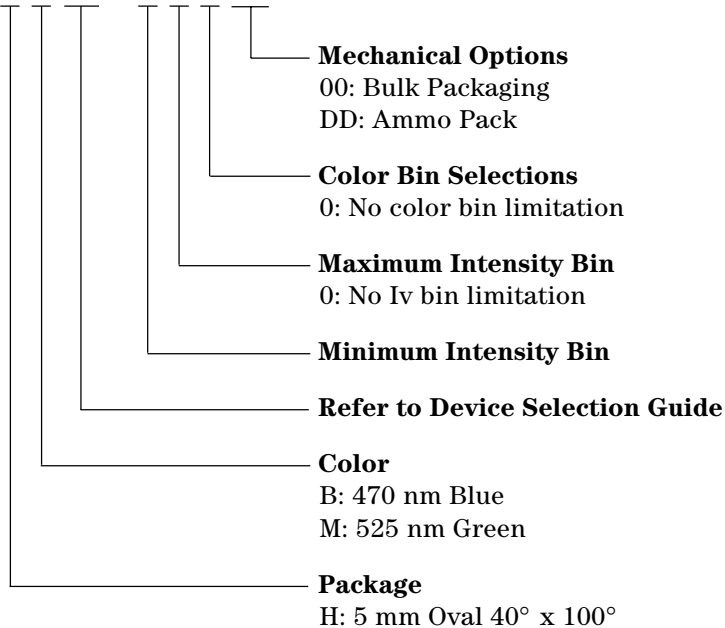

Absolute Maximum Ratings at $T_A = 25^\circ\text{C}$

Parameter	Value
DC Forward Current ^[1]	30 mA
Peak Pulsed Forward Current ^[2]	100 mA
Power Dissipation	117 mW
Reverse Voltage	5 V ($I_R = 10 \mu\text{A}$)
LED Junction Temperature	130°C
Operating Temperature Range	-40°C to +80°C
Storage Temperature Range	-40°C to +100°C

Notes:

- Derate linearly as shown in Figure 3.
- Duty factor 10%, Frequency 1kHz

Electrical /Optical Characteristics Table

$T_A = 25^\circ\text{C}$

Parameter	Symbol	Min.	Typ.	Max.	Units	Test Conditions
Forward Voltage						
Blue ($\lambda_d = 470 \text{ nm}$)	V_F		3.2	3.7	V	$I_F = 20 \text{ mA}$
Green ($\lambda_d = 525 \text{ nm}$)			3.2	3.9		
Reverse Voltage	V_R	5				$I_R = 10 \mu\text{A}$
Capacitance						
Blue ($\lambda_d = 470 \text{ nm}$)	C		40		pF	$V_F = 0, f = 1 \text{ MHz}$
Green ($\lambda_d = 525 \text{ nm}$)						
Thermal Resistance	$R_{\theta J-PIN}$		240		°C/W	LED Junction-to-Cathode Lead
Viewing Angle						
Major Axis	$2\theta_{1/2}$		100		deg	
Minor Axis			40			
Peak Wavelength						
Blue ($\lambda_d = 470 \text{ nm}$)	λ_P		467		nm	Peak of Wavelength of Spectral Distribution at $I_F = 20 \text{ mA}$
Green ($\lambda_d = 525 \text{ nm}$)			520			
Spectral Halfwidth						
Blue ($\lambda_d = 470 \text{ nm}$)	$\Delta\lambda_{1/2}$		24		nm	Wavelength Width at Spectral Distribution Power Point at $I_F = 20 \text{ mA}$
Green ($\lambda_d = 525 \text{ nm}$)			35			
Luminous Efficacy						
Blue ($\lambda_d = 470 \text{ nm}$)	η_v		75		lm/W	Emitted luminous power/Emitted radiant power
Green ($\lambda_d = 525 \text{ nm}$)			520			

Notes:

- $2\theta_{1/2}$ is the off-axis angle where the luminous intensity is $1/2$ the on axis intensity.
- The radiant intensity, I_e in watts per steradian, may be found from the equation $I_e = I_v/\eta_v$ where I_v is the luminous intensity in candelas and η_v is the luminous efficacy in lumens/watt.

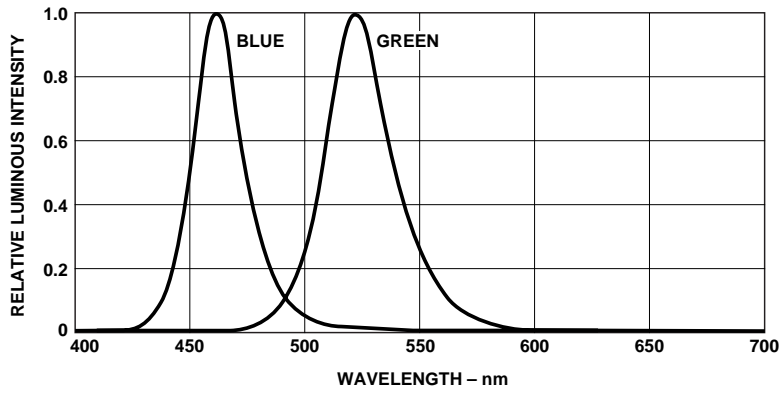

Figure 1. Relative intensity vs. wavelength.

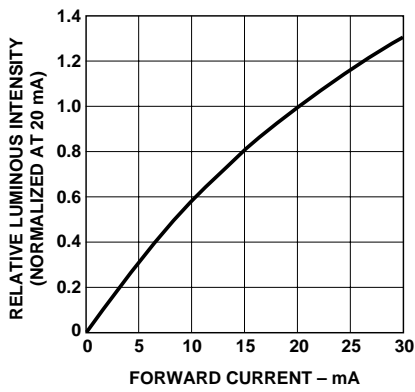

Figure 2. Relative luminous intensity vs. forward current.

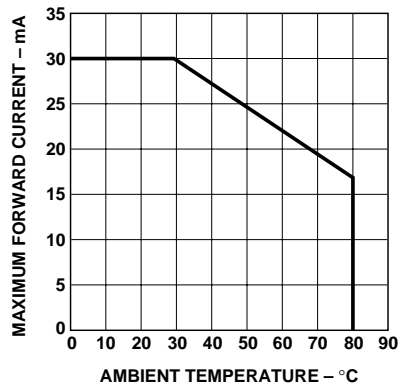

Figure 3. Forward current vs. ambient temperature.

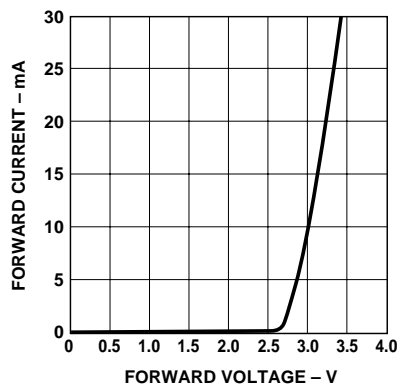

Figure 4. Forward current vs. forward voltage.

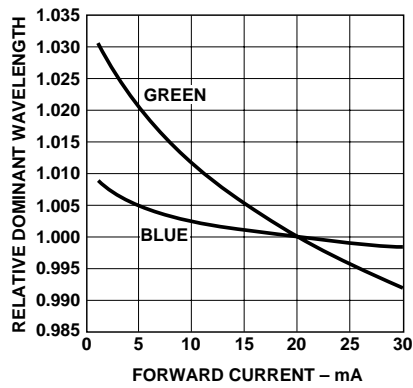

Figure 5. Relative dominant wavelength vs. forward current.

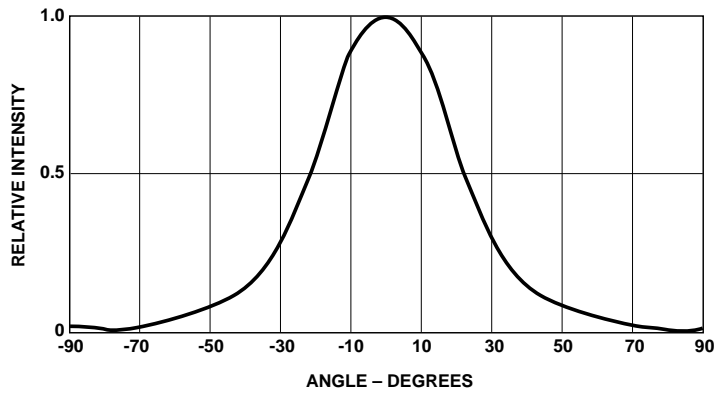

Figure 6. Spatial radiation pattern – minor axis.

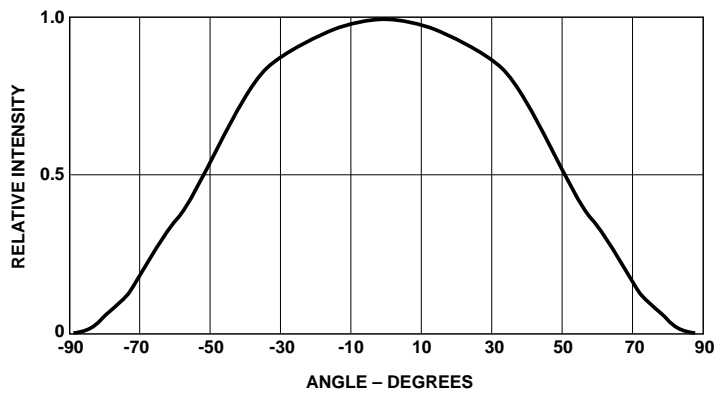

Figure 7. Spatial radiation pattern – major axis.

Intensity Bin Limits (mcd @ 20 mA)

Bin Name	Min.	Max.
F	110	140
G	140	180
H	180	240
J	240	310
K	310	400
L	400	520
M	520	680
N	680	880
P	880	1150
Q	1150	1500
R	1500	1900

Tolerance will be $\pm 15\%$ of these limits.

Green Color Bin Table

Bin	Min. Dom.	Max. Dom.	Xmin.	Ymin.	Xmax.	Ymax.
1	520.0	524.0	0.0743	0.8338	0.1856	0.6556
			0.1650	0.6586	0.1060	0.8292
2	524.0	528.0	0.1060	0.8292	0.2068	0.6463
			0.1856	0.6556	0.1387	0.8148
3	528.0	532.0	0.1387	0.8148	0.2273	0.6344
			0.2068	0.6463	0.1702	0.7965
4	532.0	536.0	0.1702	0.7965	0.2469	0.6213
			0.2273	0.6344	0.2003	0.7764
5	536.0	540.0	0.2003	0.7764	0.2659	0.6070
			0.2469	0.6213	0.2296	0.7543

Tolerance for each bin limit is ± 0.5 nm

Blue Color Bin Table

Bin	Min. Dom.	Max. Dom.	Xmin.	Ymin.	Xmax.	Ymax.
1	460.0	464.0	0.1440	0.0297	0.1766	0.0966
			0.1818	0.0904	0.1374	0.0374
2	464.0	468.0	0.1374	0.0374	0.1699	0.1062
			0.1766	0.0966	0.1291	0.0495
3	468.0	472.0	0.1291	0.0495	0.1616	0.1209
			0.1699	0.1062	0.1187	0.0671
4	472.0	476.0	0.1187	0.0671	0.1517	0.1423
			0.1616	0.1209	0.1063	0.0945
5	476.0	480.0	0.1063	0.0945	0.1397	0.1728
			0.1517	0.1423	0.0913	0.1327

Tolerance for each bin limit is ± 0.5 nm

Note:

1. All bin categories are established for classification of products. Products may not be available in all bin categories. Please contact your Avago representative for further information.

Avago Color Bin on CIE Chromaticity Diagram

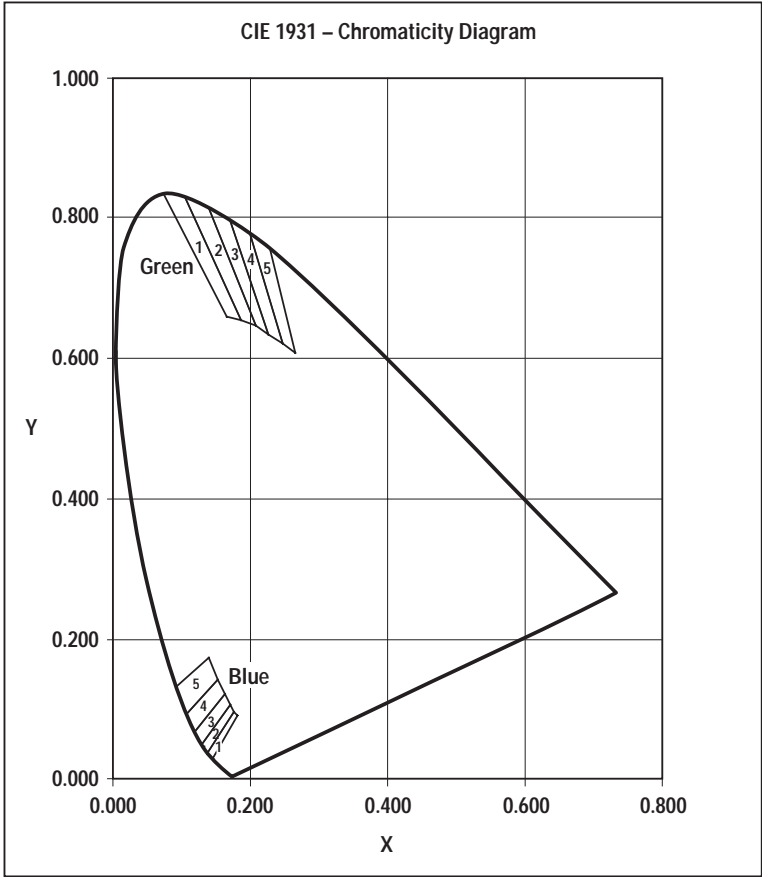

Relative Light Output vs. Junction Temperature

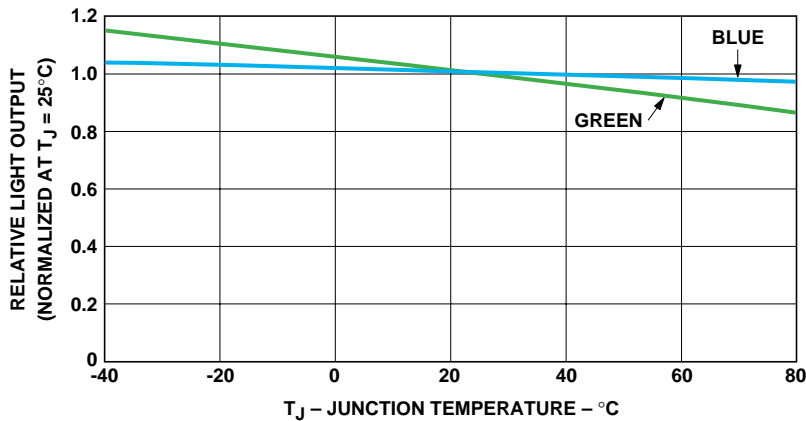

Precautions:

Lead Forming

- The leads of an LED lamp may be preformed or cut to length prior to insertion and soldering into PC board.
- If lead forming is required before soldering, care must be taken to avoid any excessive mechanical stress induced to LED package. Otherwise, cut the leads of LED to length after soldering process at room temperature. The solder joint formed will absorb the mechanical stress of the lead cutting from traveling to the LED chip die attach and wirebond.
- For better control, it is recommended to use proper tool to precisely form and cut the leads to applicable length rather than doing it manually.

Soldering Conditions

- Care must be taken during PCB assembly and soldering process to prevent damage to LED component.
- The closest LED is allowed to solder on board is 1.59 mm below the body (encapsulant epoxy) for those parts without standoff.
- Recommended soldering conditions:

	Wave Soldering	Manual Solder Dipping
Pre-heat Temperature	105 °C Max.	–
Pre-heat Time	30 sec Max.	–
Peak Temperature	250 °C Max.	260 °C Max.
Dwell Time	3 sec Max.	5 sec Max.

- Wave soldering parameter must be set and maintained according to recommended temperature and dwell time in the solder wave. Customer is advised to periodically check on the soldering profile to ensure the soldering profile used is always conforming to recommended soldering condition.

Notes:

1. PCB with different size and design (component density) will have different heat mass (heat capacity). This might cause a change in temperature experienced by the board if same wave soldering setting is used. So, it is recommended to recalibrate the soldering profile again before loading a new type of PCB.
2. Avago Technologies' high brightness LED are using high efficiency LED die with single wire bond as shown below. Customer is advised to take extra precaution during wave soldering to ensure that the maximum wave temperature is not exceeding 250°C. Overstressing the LED during soldering process might cause premature failure to the LED due to delamination.

Avago Technologies LED Configuration

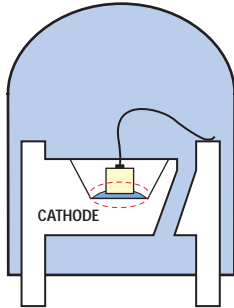

Note: Electrical connection between bottom surface of LED die and the lead frame material through conductive paste of solder.

- If necessary, use fixture to hold the LED component in proper orientation with respect to the PCB during soldering process.
- At elevated temperature, the LED is more susceptible to mechanical stress. Therefore, PCB must be allowed to cool down to room temperature prior to handling, which includes removal of jigs, fixtures or pallet.
- Special attention must be given to board fabrication, solder masking, surface plating and lead holes size and component orientation to assure the solderability.

- Recommended PC board plated through hole sizes for LED component leads:

LED Component Lead Size	Diagonal	Plated Through Hole Diameter
0.457 x 0.457 mm (0.018 x 0.018 inch)	0.646 mm (0.025 inch)	0.976 to 1.078 mm (0.038 to 0.042 inch)
0.508 x 0.508 mm (0.020 x 0.020 inch)	0.718 mm (0.028 inch)	1.049 to 1.150 mm (0.041 to 0.045 inch)

Note: Refer to application note AN1027 for more information on soldering LED components.

- Over sizing of plated through hole can lead to twisting or improper LED placement during auto insertion. Under sizing plated through hole can lead to mechanical stress on the epoxy lens during clinching.

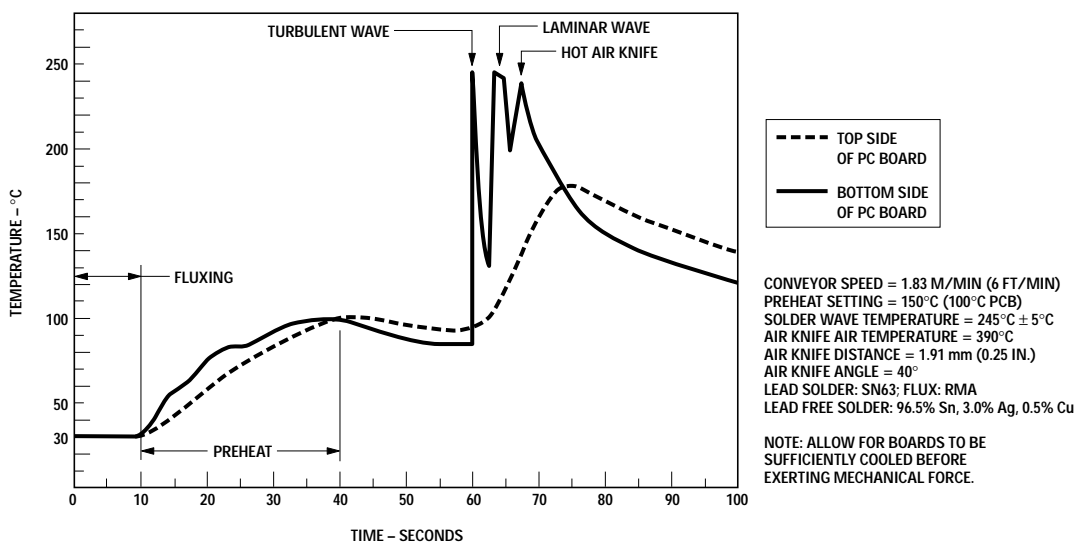
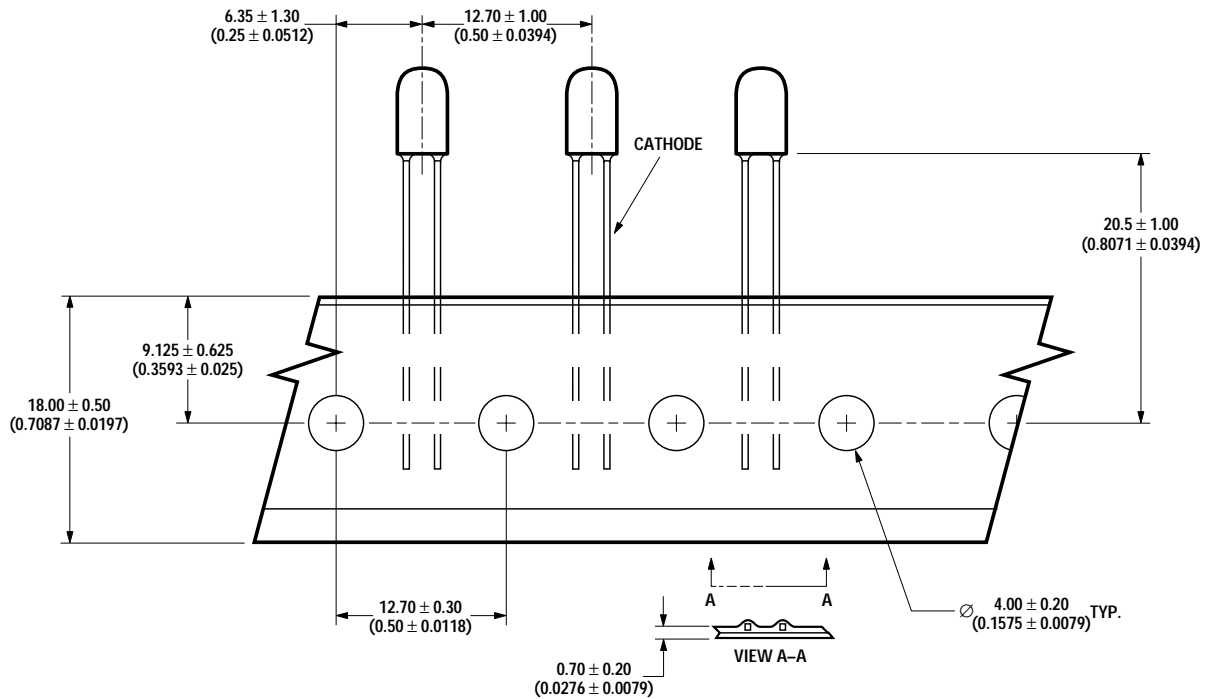

Figure 8. Recommended wave soldering profile.

Ammo Packs Drawing



ALL DIMENSIONS IN MILLIMETERS (INCHES).

Note: The ammo-packs drawing is applicable for packaging option -DD & -ZZ and regardless of standoff or non-standoff.

Packaging Box Ammo Packs

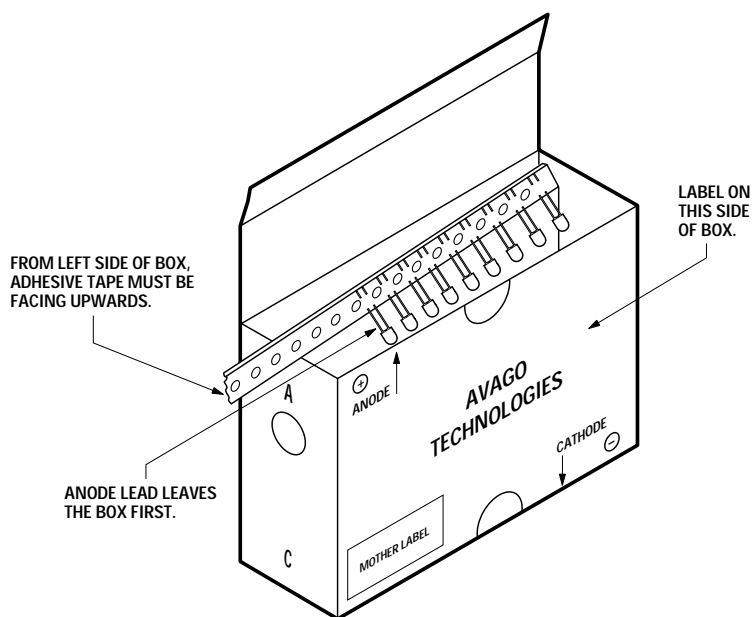

Note: For InGaN device, the ammo pack packaging box contains ESD logo.

DISCLAIMER

AVAGO'S PRODUCTS AND SOFTWARE ARE NOT SPECIFICALLY DESIGNED, MANUFACTURED OR AUTHORIZED FOR SALE AS PARTS, COMPONENTS OR ASSEMBLIES FOR THE PLANNING, CONSTRUCTION, MAINTENANCE OR DIRECT OPERATION OF A NUCLEAR FACILITY OR FOR USE IN MEDICAL DEVICES OR APPLICATIONS. CUSTOMER IS SOLELY RESPONSIBLE, AND WAIVES ALL RIGHTS TO MAKE CLAIMS AGAINST AVAGO OR ITS SUPPLIERS, FOR ALL LOSS, DAMAGE, EXPENSE OR LIABILITY IN CONNECTION WITH SUCH USE.

For product information and a complete list of distributors, please go to our website: www.avagotech.com

Avago, Avago Technologies, and the A logo are trademarks of Avago Technologies Limited in the United States and other countries.
Data subject to change. Copyright © 2007 Avago Technologies Limited. All rights reserved. Obsoletes 5989-4145EN
AV02-0206EN March 20, 2007

Avago
TECHNOLOGIES