

# HR5<sup>®</sup> HR25 Series

## World's Smallest Round Type Multiple Contact Connectors

### ■ GENERAL

The HR25 Series is the world's smallest high-density round type connector. It was developed using Hirose Electric's long experience with miniaturization technology in answer to the continuing need for the ever greater miniaturization and high-density construction of a wide variety of electronic equipment.

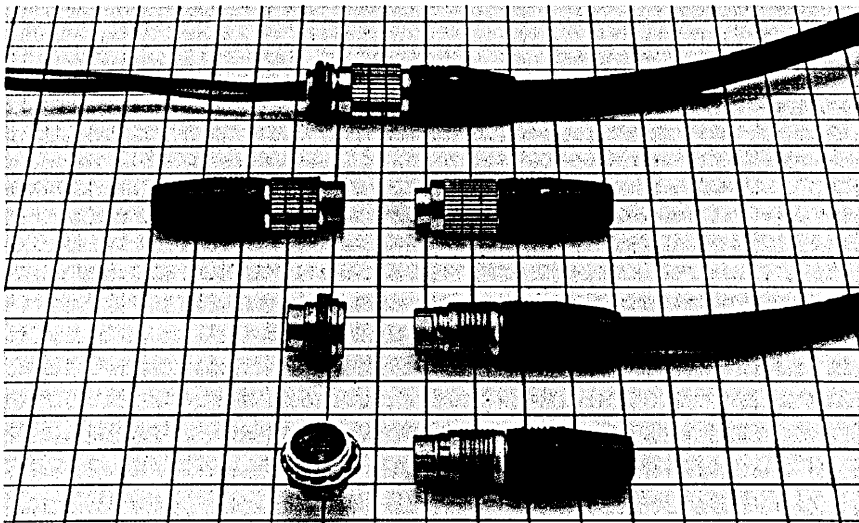

### ■ FEATURES

- (1) The HR25 is the world's smallest high-density connector.  
These connectors fit a maximum of 20 contacts into a maximum outside diameter of 12.5 mm.  
The lock mechanism is available in a screw lock type and a push-pull lock type.
- (2) The structure is such that the pins will not become misshapen even if the male pins are inserted incorrectly.  
The contacts of the plug and the male contacts of the receptacle are designed in such a way that even if the two pieces are engaged, the safe positioning of the male contacts will not result in a collision between contacts.
- (3) These connectors prevent water from entering the interior of the set.  
Installing a rubber gasket to the panel mounting part of the receptacle prevents water from entering the interior of the set.
- (4) Contacts are gold plated as a standard to maintain contact stability.
- (5) The number of contacts is available in 4, 6, 8, 12, 16, or 20 contacts allowing these connectors to be used over a wide range of applications.
- (6) Available in a variety of types.  
In addition to the soldered wiring type, these connectors are available in the crimp-style wiring type and board direct mounting type allowing the connector to be matched to the job.

### ■ APPLICATIONS

CCD cameras, measuring instruments, wide variety of sensors, mobile radio, medical equipment, etc.

## MAJOR SPECIFIED MATERIALS

Part Name	Material	Finish
Male contacts	Phosphor bronze	Gold and partial gold plating
Female contacts	Phosphor bronze	Partial gold plating
Insulation	PPS resin	(Black)
Shell	Brass and zinc alloy	Nickel plating

## STRUCTURE OF THE PRODUCT NUMBER

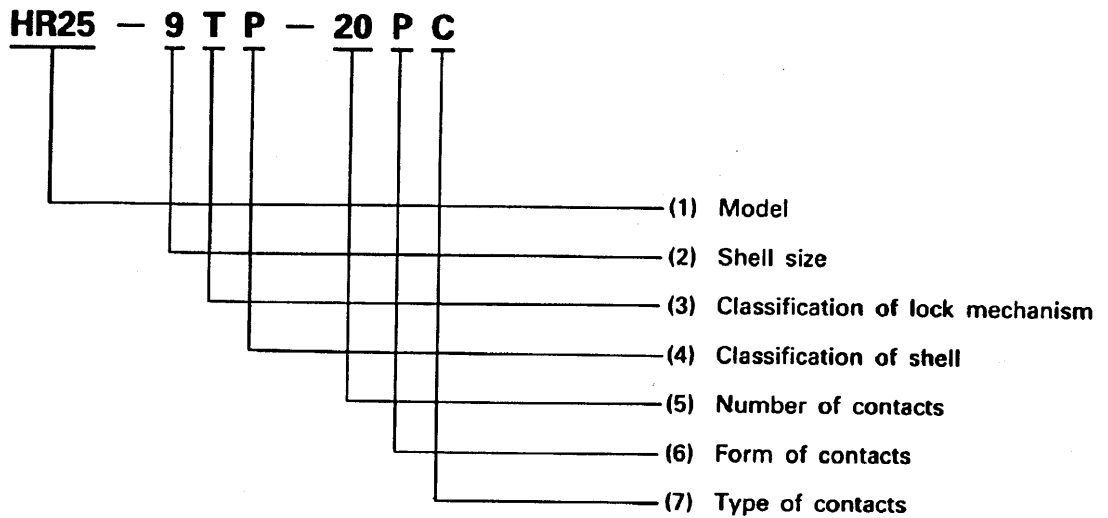

(1) Model: Indicates the HR25 Series.

(2) Shell size: Indicates the outer diameter of the engaging portion of the plug.

(3) Classification of lock mechanism: Indicated as described below.

T: Screw lock system                      No symbol: Push-pull lock system

(4) Classification of shell: As described below.

P: Plug                      R: Receptacle                      J: Jack

(5) Number of contacts

(6) Form of contacts: As described below:

P: Male contacts                      S: Female contacts

(7) Type of contacts: The wiring system used or the type of contacts are classified in alphabetical order:

Example. C: Crimp-style contacts

## ■ Diagrams of Connectors in Combination

### ◇ Screw Lock Type

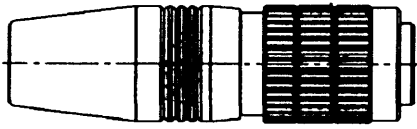

Solder type plug (HR25-※TP-※※)  
Crimp type plug (HR25-9TP-※※C)

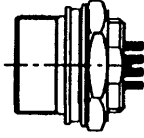

Solder type receptacle (HR25-※TR-※※)  
Crimp type receptacle (HR25-9TR-※※C)

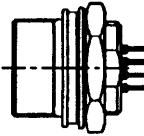

Dip type receptacle (HR25-※TR-※※A)

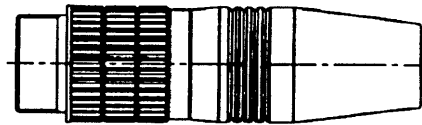

Solder type jack (HR25-※TJ-※※)  
Crimp type jack (HR25-9TJ-※※C)

### ◇ Push-Pull Lock Type

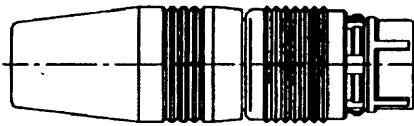

Solder type plug (HR25-※P-※※)  
Crimp type plug (HR25-9P-※※C)

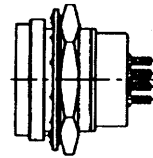

Solder type receptacle (HR25-※R-※※)  
Crimp type receptacle (HR25-9R-※※C)

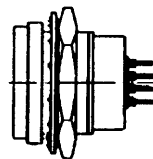

Dip type receptacle (HR25-※R-※※A)

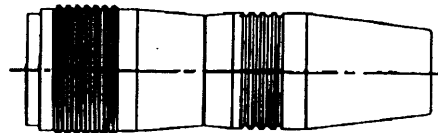

Solder type jack (HR25-※J-※※)  
Crimp type jack (HR25-9J-※※C)

When the plug is a male contact (i.e., pin insert side) product, a female contact (i.e., socket insert side) product should be used for receptacles and jacks. Conversely, when the plug is a female contact (i.e., socket insert side) product, a male contact (i.e., pin insert side) product should be used for receptacles and jacks.

## ◎ Screw Lock Type

Solder type

### ■ PLUGS

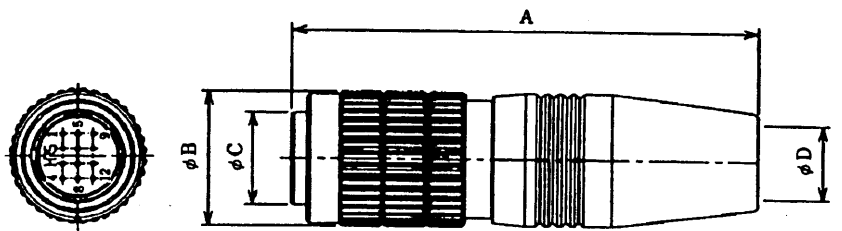
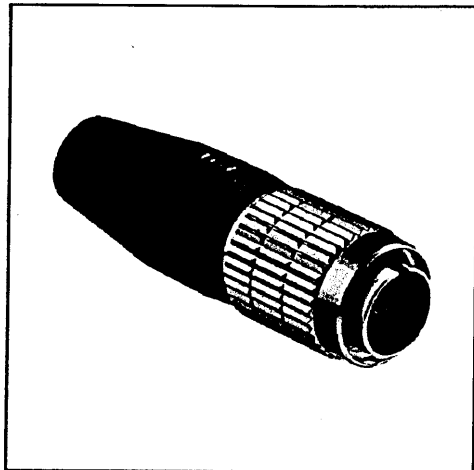

(An example of the form is illustrated.)

HRS No.	Product No.	Number of Contacts	A	φB	φC	φD	Weight
125-0001-8	HR25-7TP-4P	4	35	10.5	6.7	5	8g
125-0002-0	HR25-7TP-4S	4	35	10.5	6.7	5	8g
125-0003-3	HR25-7TP-6P	6	35	10.5	6.7	5	8g
125-0004-6	HR25-7TP-6S	6	35	10.5	6.7	5	8g
125-0005-9	HR25-7TP-8P	8	35	10.5	6.7	5	8g
125-0006-1	HR25-7TP-8S	8	35	10.5	6.7	5	8g
125-0101-2	HR25-9TP-12P	12	43	12.5	8.7	7	13g
125-0102-5	HR25-9TP-12S	12	43	12.5	8.7	7	13g
125-0103-8	HR25-9TP-16P	16	43	12.5	8.7	7	13g
125-0104-0	HR25-9TP-16S	16	43	12.5	8.7	7	13g
125-0105-3	HR25-9TP-20P	20	43	12.5	8.7	7	13g
125-0106-6	HR25-9TP-20S	20	43	12.5	8.7	7	13g

### ■ RECEPTACLES

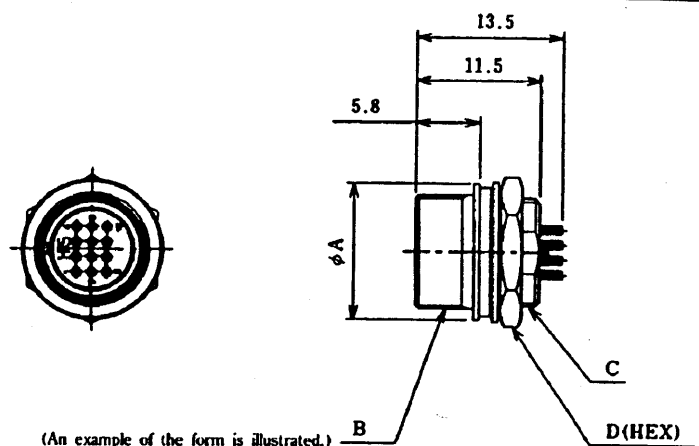
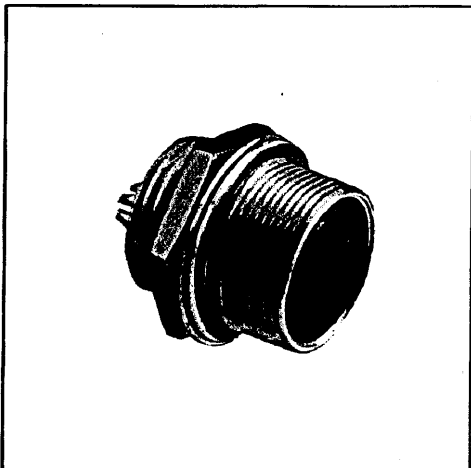

(An example of the form is illustrated.)

HRS No.	Product No.	Number of Contacts	φA	B	C	D	Weight
125-0007-4	HR25-7TR-4S	4	10.6	M8.5×0.5	M8×0.5	10	3g
125-0008-7	HR25-7TR-4P	4	10.6	M8.5×0.5	M8×0.5	10	3g
125-0009-0	HR25-7TR-6S	6	10.6	M8.5×0.5	M8×0.5	10	3g
125-0010-9	HR25-7TR-6P	6	10.6	M8.5×0.5	M8×0.5	10	3g
125-0011-1	HR25-7TR-8S	8	10.6	M8.5×0.5	M8×0.5	10	3g
125-0012-4	HR25-7TR-8P	8	10.6	M8.5×0.5	M8×0.5	10	3g
125-0107-9	HR25-9TR-12S	12	12.6	M10.5×0.5	M10×0.75	12	4g
125-0108-1	HR25-9TR-12P	12	12.6	M10.5×0.5	M10×0.75	12	4g
125-0109-4	HR25-9TR-16S	16	12.6	M10.5×0.5	M10×0.75	12	4g
125-0110-3	HR25-9TR-16P	16	12.6	M10.5×0.5	M10×0.75	12	4g
125-0111-6	HR25-9TR-20S	20	12.6	M10.5×0.5	M10×0.75	12	4g
125-0112-9	HR25-9TR-20P	20	12.6	M10.5×0.5	M10×0.75	12	4g

## JACKS

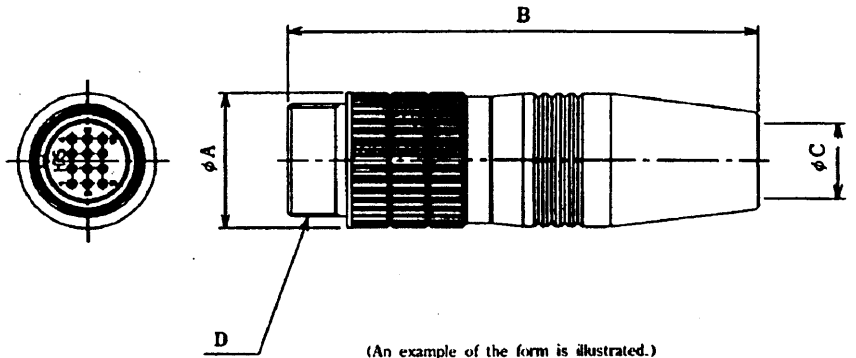
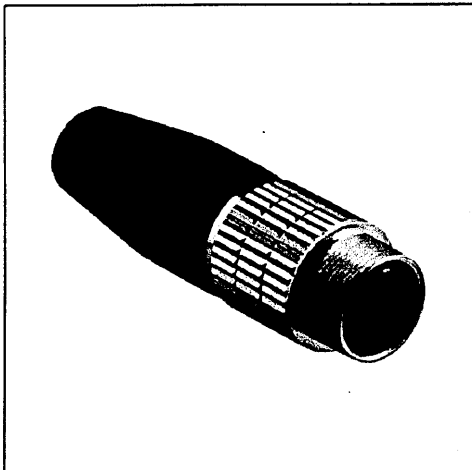

(An example of the form is illustrated.)

HRS No.	Product No.	Number of Contacts	φA	B	φC	D	Weight
125-0013-7	HR25-7TJ-4S	4	10.6	35	5	M8.5×0.5	8g
125-0014-0	HR25-7TJ-4P	4	10.6	35	5	M8.5×0.5	8g
125-0015-2	HR25-7TJ-6S	6	10.6	35	5	M8.5×0.5	8g
125-0016-5	HR25-7TJ-6P	6	10.6	35	5	M8.5×0.5	8g
125-0017-8	HR25-7TJ-8S	8	10.6	35	5	M8.5×0.5	8g
125-0018-0	HR25-7TJ-8P	8	10.6	35	5	M8.5×0.5	8g
125-0113-1	HR25-9TJ-12S	12	12.6	43	7	M10.5×0.5	12g
125-0114-4	HR25-9TJ-12P	12	12.6	43	7	M10.5×0.5	12g
125-0115-7	HR25-9TJ-16S	16	12.6	43	7	M10.5×0.5	12g
125-0116-0	HR25-9TJ-16P	16	12.6	43	7	M10.5×0.5	12g
125-0117-2	HR25-9TJ-20S	20	12.6	43	7	M10.5×0.5	12g
125-0118-5	HR25-9TJ-20P	20	12.6	43	7	M10.5×0.5	12g

## Board direct mounting type

## RECEPTACLES

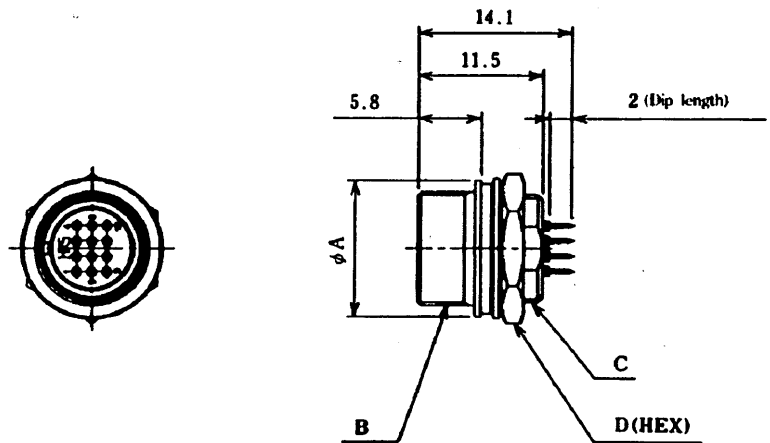
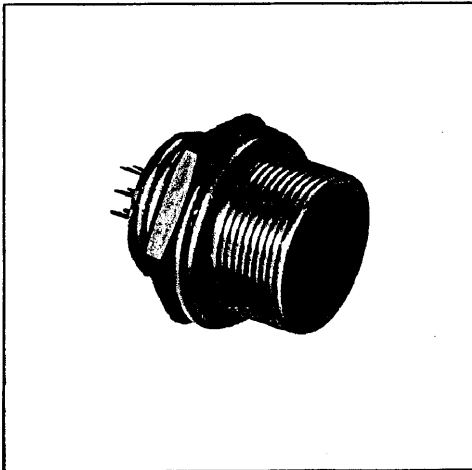

(An example of the form is illustrated.)

HRS No.	Product No.	Number of Contacts	φA	B	C	D	Weight
125-0019-3	HR25-7TR-4SA	4	10.6	M8.5×0.5	M8×0.5	10	3g
125-0020-2	HR25-7TR-4PA	4	10.6	M8.5×0.5	M8×0.5	10	3g
125-0021-5	HR25-7TR-6SA	6	10.6	M8.5×0.5	M8×0.5	10	3g
125-0022-8	HR25-7TR-6PA	6	10.6	M8.5×0.5	M8×0.5	10	3g
125-0023-0	HR25-7TR-8SA	8	10.6	M8.5×0.5	M8×0.5	10	3g
125-0024-3	HR25-7TR-8PA	8	10.6	M8.5×0.5	M8×0.5	10	3g
125-0119-8	HR25-9TR-12SA	12	12.6	M10.5×0.5	M10×0.75	12	4g
125-0120-7	HR25-9TR-12PA	12	12.6	M10.5×0.5	M10×0.75	12	4g
125-0121-0	HR25-9TR-16SA	16	12.6	M10.5×0.5	M10×0.75	12	4g
125-0122-2	HR25-9TR-16PA	16	12.6	M10.5×0.5	M10×0.75	12	4g
125-0123-5	HR25-9TR-20SA	20	12.6	M10.5×0.5	M10×0.75	12	4g
125-0124-8	HR25-9TR-20PA	20	12.6	M10.5×0.5	M10×0.75	12	4g

## Crimp type

### ■ PLUGS

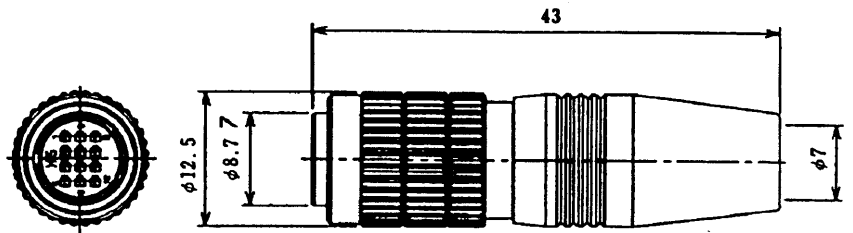
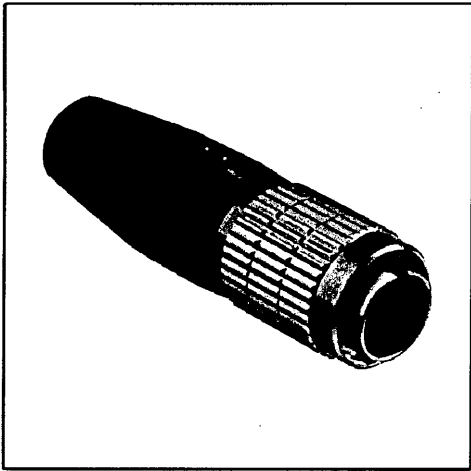

(An example of the form is illustrated.)

HRS No.	Product No.	Number of Contacts	Weight
125-0401-6	HR25-9TP-12PC	12	12g
125-0402-9	HR25-9TP-12SC	12	12g
125-0403-1	HR25-9TP-16PC	16	12g
125-0404-4	HR25-9TP-16SC	16	12g
125-0405-7	HR25-9TP-20PC	20	12g
125-0406-0	HR25-9TP-20SC	20	12g

### ■ RECEPTACLES

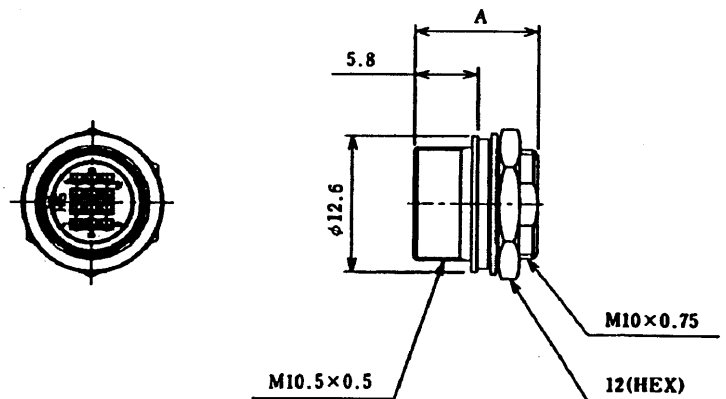
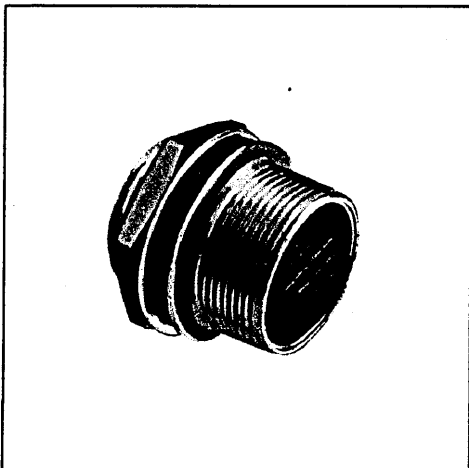

(An example of the form is illustrated.)

HRS No.	Product No.	Number of Contacts	A	Weight
125-0407-2	HR25-9TR-12SC	12	11.5	3g
125-0408-5	HR25-9TR-12PC	12	13	3g
125-0409-8	HR25-9TR-16SC	16	11.5	3g
125-0410-7	HR25-9TR-16PC	16	13	3g
125-0411-0	HR25-9TR-20SC	20	11.5	3g
125-0412-2	HR25-9TR-20PC	20	13	3g

# JACKS

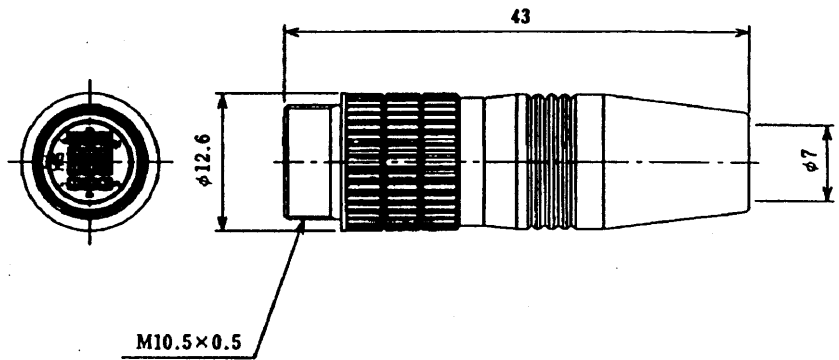
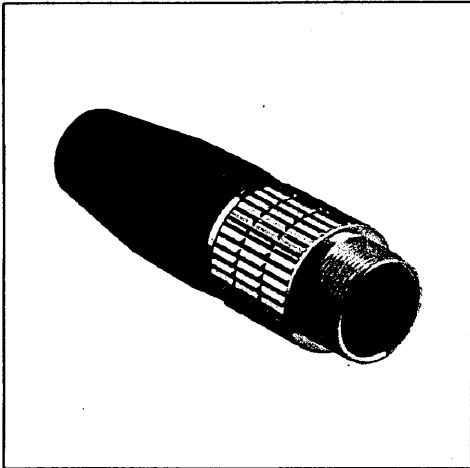

(An example of the form is illustrated.)

HRS No.	Product No.	Number of Contacts	Weight
125-0413-5	HR25-9TJ-12SC	12	12g
125-0414-8	HR25-9TJ-12PC	12	12g
125-0415-0	HR25-9TJ-16SC	16	12g
125-0416-3	HR25-9TJ-16PC	16	12g
125-0417-6	HR25-9TJ-20SC	20	12g
125-0418-9	HR25-9TJ-20PC	20	12g

## ◎ Push-Pull Lock Type

Solder type

### ■ PLUGS

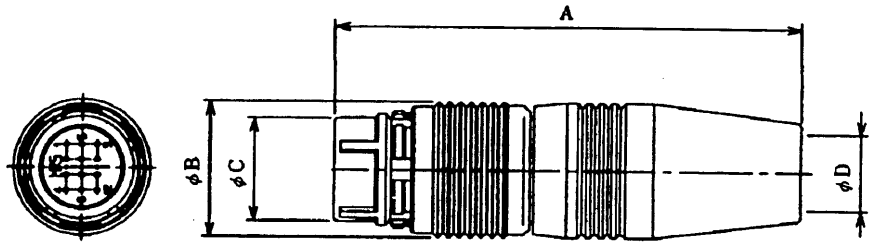
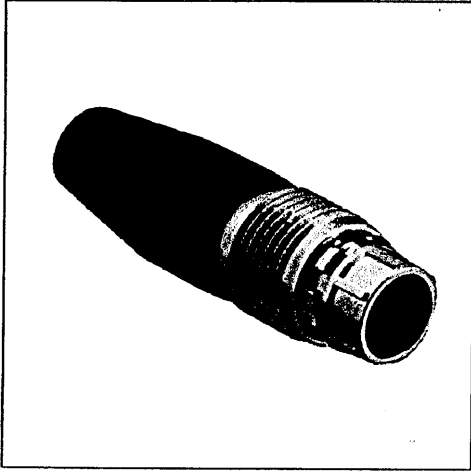

(An example of the form is illustrated.)

HRS No.	Product No.	Number of Contacts	A	φB	φC	φD	Weight
125-0201-7	HR25-7P-4P	4	34.8	10.5	7.45	5	8g
125-0202-0	HR25-7P-4S	4	34.8	10.5	7.45	5	8g
125-0203-2	HR25-7P-6P	6	34.8	10.5	7.45	5	8g
125-0204-5	HR25-7P-6S	6	34.8	10.5	7.45	5	8g
125-0205-8	HR25-7P-8P	8	34.8	10.5	7.45	5	8g
125-0206-0	HR25-7P-8S	8	34.8	10.5	7.45	5	8g
125-0301-1	HR25-9P-12P	12	42.8	12.5	9.45	7	13g
125-0302-4	HR25-9P-12S	12	42.8	12.5	9.45	7	13g
125-0303-7	HR25-9P-16P	16	42.8	12.5	9.45	7	13g
125-0304-0	HR25-9P-16S	16	42.8	12.5	9.45	7	13g
125-0305-2	HR25-9P-20P	20	42.8	12.5	9.45	7	13g
125-0306-5	HR25-9P-20S	20	42.8	12.5	9.45	7	13g

### ■ RECEPTACLES

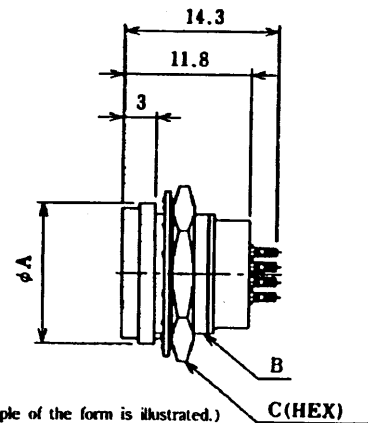
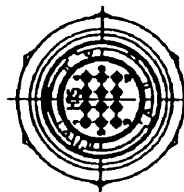
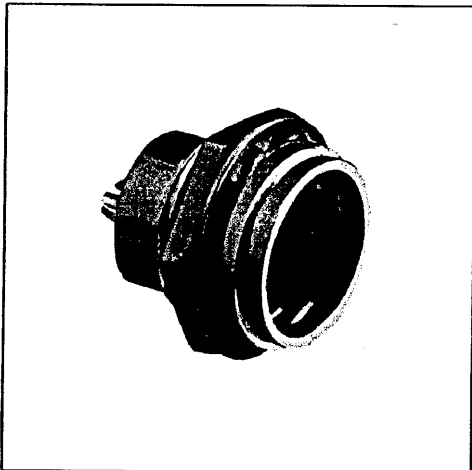

(An example of the form is illustrated.)

HRS No.	Product No.	Number of Contacts	φA	B	C	Weight
125-0207-3	HR25-7R-4S	4	11	M10×0.75	12	4g
125-0208-6	HR25-7R-4P	4	11	M10×0.75	12	4g
125-0209-9	HR25-7R-6S	6	11	M10×0.75	12	4g
125-0210-8	HR25-7R-6P	6	11	M10×0.75	12	4g
125-0211-0	HR25-7R-8S	8	11	M10×0.75	12	4g
125-0212-3	HR25-7R-8P	8	11	M10×0.75	12	4g
125-0307-8	HR25-9R-12S	12	13	M12×0.75	14	5g
125-0308-0	HR25-9R-12P	12	13	M12×0.75	14	5g
125-0309-3	HR25-9R-16S	16	13	M12×0.75	14	5g
125-0310-2	HR25-9R-16P	16	13	M12×0.75	14	5g
125-0311-5	HR25-9R-20S	20	13	M12×0.75	14	5g
125-0312-8	HR25-9R-20P	20	13	M12×0.75	14	5g



## JACKS

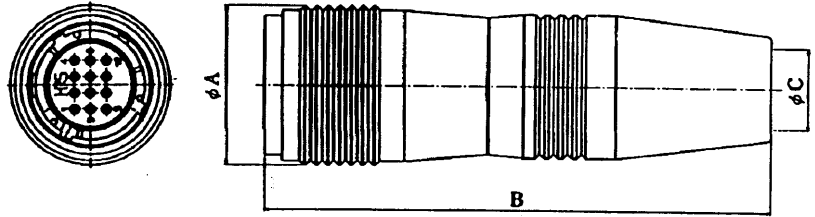
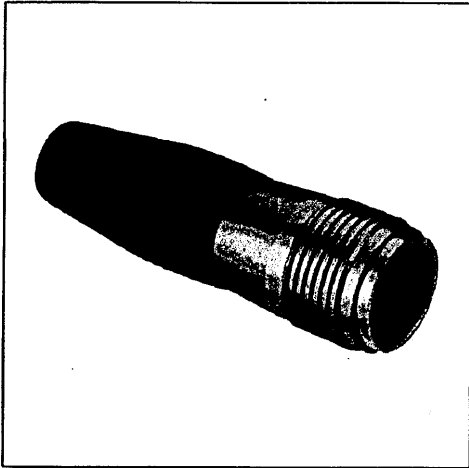

(An example of the form is illustrated.)

HRS No.	Product No.	Number of Contacts	φA	B	φC	Weight
125-0213-6	HR25-7J-4S	4	11.8	35.8	5	9g
125-0214-9	HR25-7J-4P	4	11.8	35.8	5	9g
125-0215-1	HR25-7J-6S	6	11.8	35.8	5	9g
125-0216-4	HR25-7J-6P	6	11.8	35.8	5	9g
125-0217-7	HR25-7J-8S	8	11.8	35.8	5	9g
125-0218-0	HR25-7J-8P	8	11.8	35.8	5	9g
125-0313-0	HR25-9J-12S	12	13.8	43.8	7	14g
125-0314-3	HR25-9J-12P	12	13.8	43.8	7	14g
125-0315-6	HR25-9J-16S	16	13.8	43.8	7	14g
125-0316-9	HR25-9J-16P	16	13.8	43.8	7	14g
125-0317-1	HR25-9J-20S	20	13.8	43.8	7	14g
125-0318-4	HR25-9J-20P	20	13.8	43.8	7	14g

## Board direct mounting type

## RECEPTACLES

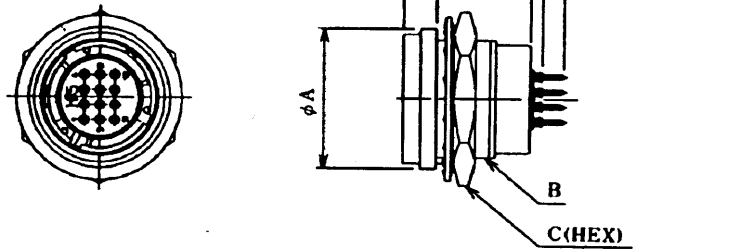
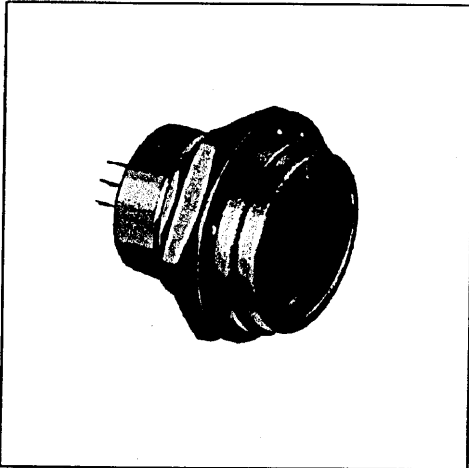

(An example of the form is illustrated.)

HRS No.	Product No.	Number of Contacts	φA	B	C	Weight
125-0219-2	HR25-7R-4SA	4	11	M10×0.75	12	4g
125-0220-1	HR25-7R-4PA	4	11	M10×0.75	12	4g
125-0221-4	HR25-7R-6SA	6	11	M10×0.75	12	4g
125-0222-7	HR25-7R-6PA	6	11	M10×0.75	12	4g
125-0223-0	HR25-7R-8SA	8	11	M10×0.75	12	4g
125-0224-2	HR25-7R-8PA	8	11	M10×0.75	12	4g
125-0319-7	HR25-9R-12SA	12	13	M12×0.75	14	5g
125-0320-6	HR25-9R-12PA	12	13	M12×0.75	14	5g
125-0321-9	HR25-9R-16SA	16	13	M12×0.75	14	5g
125-0322-1	HR25-9R-16PA	16	13	M12×0.75	14	5g
125-0323-4	HR25-9R-20SA	20	13	M12×0.75	14	5g
125-0324-7	HR25-9R-20PA	20	13	M12×0.75	14	5g

## Crimp type

### PLUGS

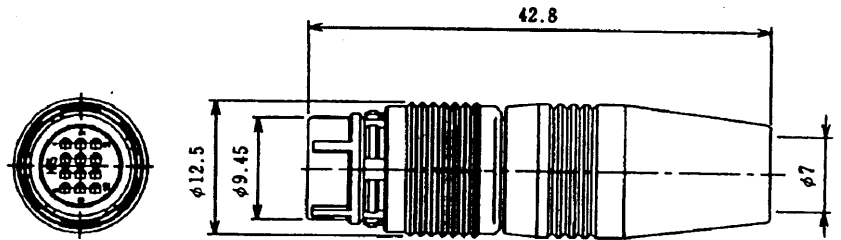
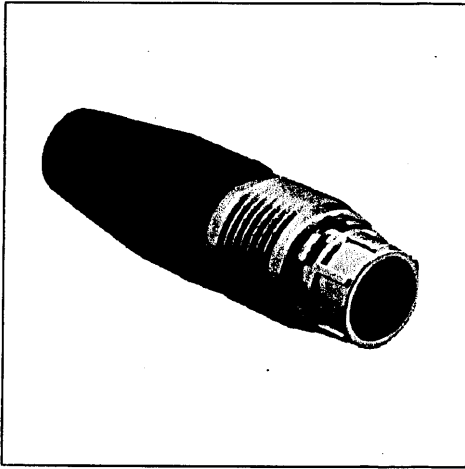

(An example of the form is illustrated.)

HRS No.	Product No.	Number of Contacts	Weight
125-0501-0	HR25-9P-12PC	12	12g
125-0502-3	HR25-9P-12SC	12	12g
125-0503-6	HR25-9P-16PC	16	12g
125-0504-9	HR25-9P-16SC	16	12g
125-0505-1	HR25-9P-20PC	20	12g
125-0506-4	HR25-9P-20SC	20	12g

### RECEPTACLES

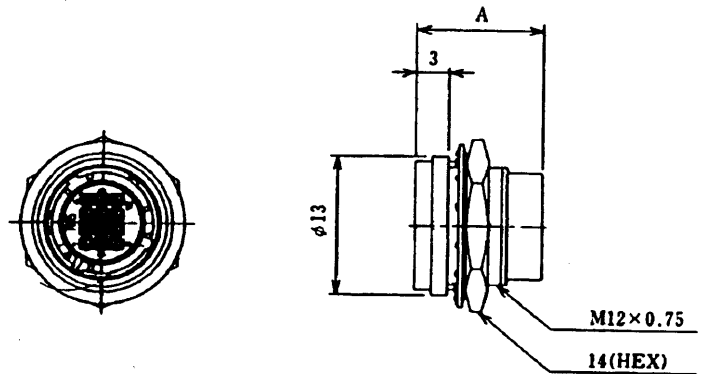
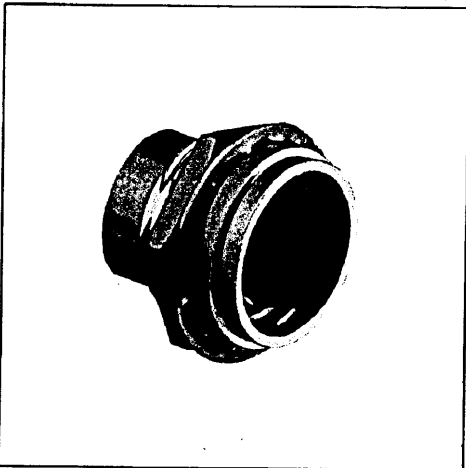

(An example of the form is illustrated.)

HRS No.	Product No.	Number of Contacts	A	Weight
125-0507-7	HR25-9R-12SC	12	11.8	4g
125-0508-0	HR25-9R-12PC	12	13.8	4g
125-0509-2	HR25-9R-16SC	16	11.8	4g
125-0510-1	HR25-9R-16PC	16	13.8	4g
125-0511-4	HR25-9R-20SC	20	11.8	4g
125-0512-7	HR25-9R-20PC	20	13.8	4g

# ■ JACKS

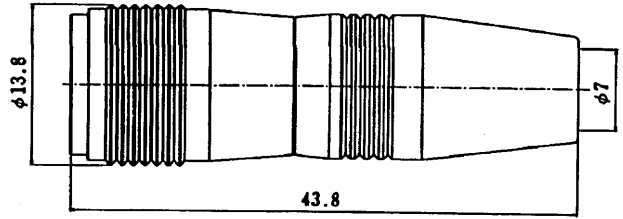
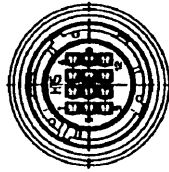
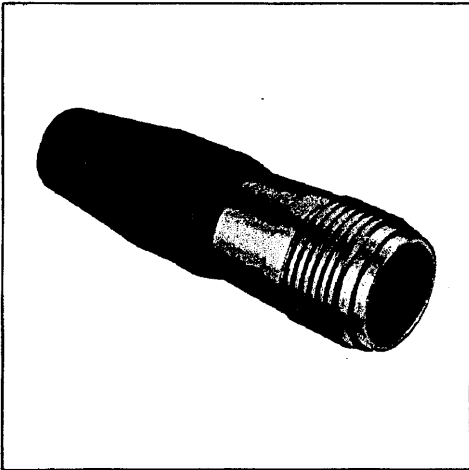

(An example of the form is illustrated.)

HRS No.	Product No.	Number of Contacts	Weight
125-0513-0	HR25-9J-12SC	12	13g
125-0514-2	HR25-9J-12PC	12	13g
125-0515-5	HR25-9J-16SC	16	13g
125-0516-8	HR25-9J-16PC	16	13g
125-0517-0	HR25-9J-20SC	20	13g
125-0518-3	HR25-9J-20PC	20	13g

## ■ CRIMP-STYLE CONTACTS

### Male Contacts

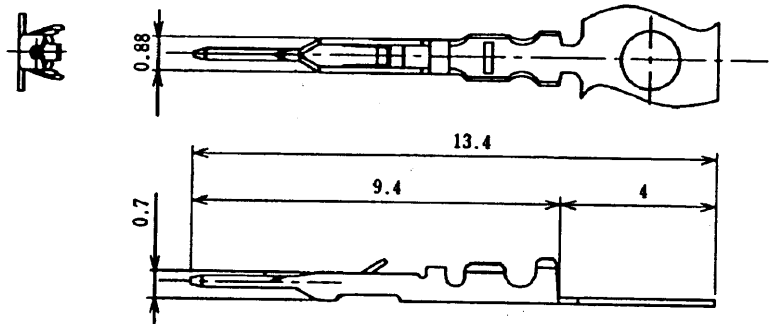

Type	HRS No.	Product No.	Suitable Wire
Loose contacts	125-0419-1	HR25-PC-111	AWG #30~32
Continuous contacts	125-0420-0	HR25-PC-211	AWG #30~32

NOTES: 1. Please use wire with a covering outside diameter of 0.71 mm or less.  
2. Loose contacts come in packages of 100 pieces. Continuous contacts come in reels of 10,000 pieces.

### Female Contacts

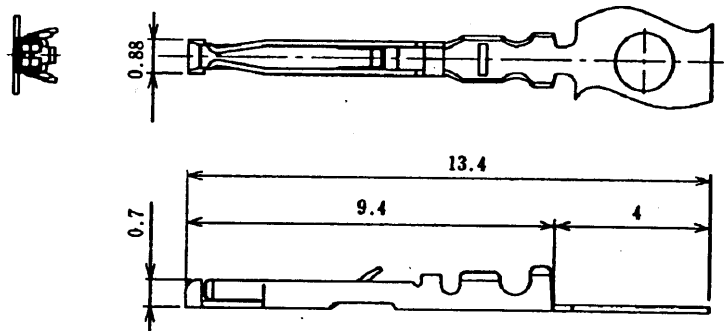

Type	HRS No.	Product No.	Suitable Wire
Loose contacts	125-0421-3	HR25-SC-111	AWG #30~32
Continuous contacts	125-0422-6	HR25-SC-211	AWG #30~32

NOTES: 1. Please use wire with a covering outside diameter of 0.71 mm or less.  
2. Loose contacts come in packages of 100 pieces. Continuous contacts come in reels of 10,000 pieces.

## ◆ Applicable Tools

Type	Item	HRS No.	Product No.	Applicable Contacts	Applicable Wire and Applicable Cable Diameter
Manual	Manual crimping tool	150-0207-3	HR25-TA3032HC	HR25-PC-111 HR25-SC-111	AWG #30
Auto	Auto crimping machine body	901-0005-4	CM-105	—	—
	Applicator	901-2040-6	AP105-HR25-1	HR25-PC-211 HR25-SC-211	AWG #30
	Cable crimping tool	150-0041-2	HR10A-TC-02	—	φ7, φ5
	Extractor	150-0091-0	HR25-TP	—	—
	Hexagon bar wrench (opposing side-to-side distance 1.27)	150-0066-3	PB205/1.27	—	—

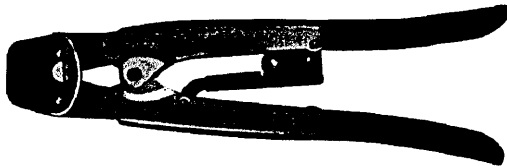

**(HR10A-TC-02)**  
Cable crimping tool



**(HR25-TA-3032HC)**  
Manual crimping tool



**(HR25-TP)**  
Extraction tool

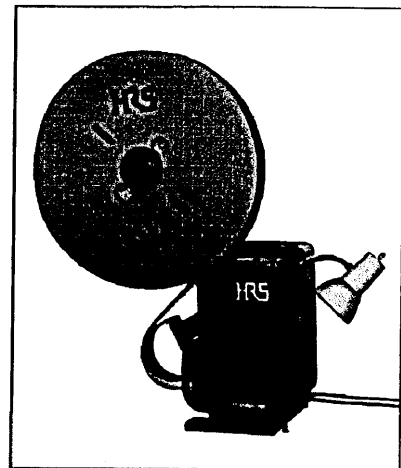

**Automatic crimper Model CM-105**



**(PB205/1.27)**  
Hexagonal wrench driver

## ◆ Outline of Wiring Work (on the Plug Side)

- The outline of wiring work for this diagram uses the soldered type as an example. The jack side is also based on the work outline of the plug; however, the receptacle side does not require a special work outline and has been omitted because of this.

## ◇ Screw Lock Type

### ● Work Procedure

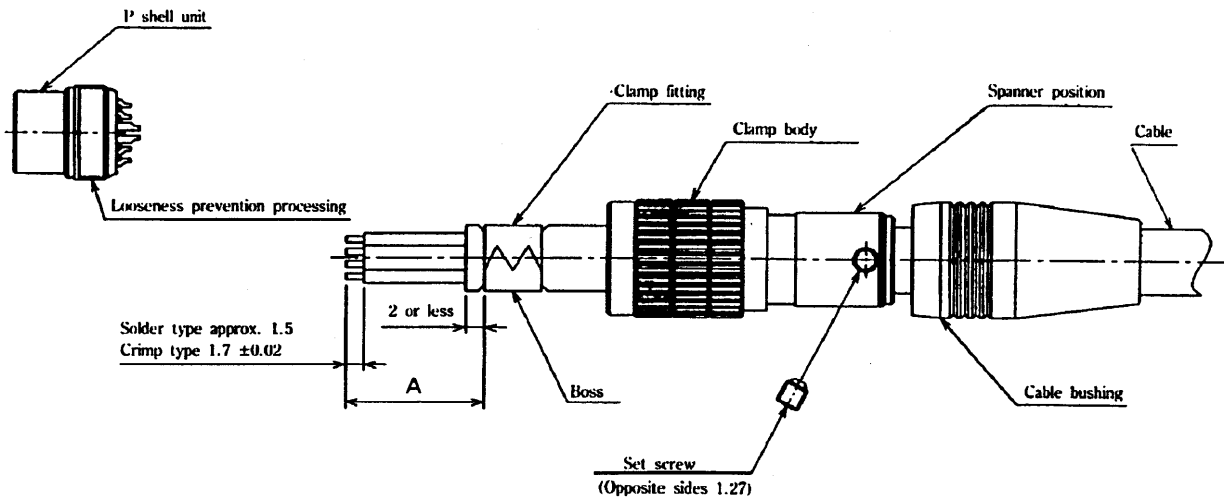

Shell size	Soldered type A dimensions	Crimp type A dimensions	Spanner spacing	Tightening torque
7	10	—	8	1Nm
9	15	19	10	1Nm

1. With regard to cables, the wire to be used should have a conductor with a nominal cross-sectional area of 0.08 mm<sup>2</sup> (AWG #28) or less in a finished form suited to each size.
2. First pass the cable bushing and the plug body in order over the cable, then cut the end at the dimensions indicated in the above diagram.
3. Mount the P shell unit in the wiring jig and perform the solder wiring.
4. Use the cable crimping jig (HR10A-TC-02) to fix the clamp fitting to the cable.
5. After performing the wiring, tighten the plug body to the screw portion of the P shell unit using the specified torque (in the above table).
6. Tighten the set screw so that the tip of the set screw falls into one of the two bosses of the clamp fitting. Note that the tightening torque of the set screw is from 0.3 to 0.4 Nm.
7. Put the cable bushing over the plug body and complete the work.  
Note that the use of a paint lock (e.g., Locktight 271 manufactured by Nihon Locktight K.K.) is recommended on the screw portion to prevent loosening of the P shell unit.

The aforementioned work procedure is for the soldered type. In the case of the crimp-style type, Steps 1 and 3 are changed as follows:

1. With regard to cables, the wire to be used should have a conductor with a nominal cross-sectional area of 0.05 mm<sup>2</sup> (AWG #30) and 0.035 mm<sup>2</sup> (AWG #32) in a finished form suited to each size.
3. Crimp a suitable crimp terminal to the conductor portion of the cable, then fit into the housing of the P shell unit.

◇ **Push-Pull Type**  
 ● **Work Procedure**

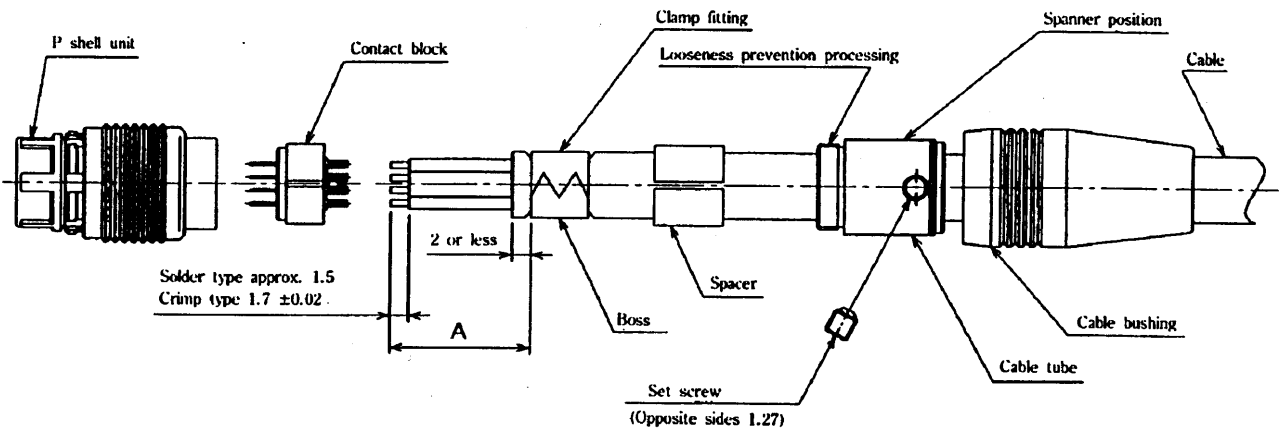

Shell size	Soldered type A dimensions	Crimp type A dimensions	Spanner spacing	Tightening torque
7	10	—	8	1Nm
9	15	19	10	1Nm

1. With regard to cables, the wire to be used should have a conductor with a nominal cross-sectional area of 0.08 mm<sup>2</sup> (AWG #28) or less in a finished form suited to each size.
2. First pass the cable bushing, cable tube, and the spacer in order over the cable, then cut the end at the dimensions indicated in the above diagram.
3. Mount the contact block in the wiring jig and perform the solder wiring.
4. Use the cable crimping jig (HR10A-TC-02) to fix the clamp fitting to the cable.
5. Insert the contact block and the spacer in order to the P shell unit.  
Be sure to align the guides at this time when making the insertion.
6. Using the tightening jig, tighten the P shell unit and the cable tube with the specified torque (in the above table).
7. Tighten the set screw so that the tip of the set screw falls into one of the two bosses of the clamp fitting.  
Note that the tightening torque of the set screw is from 0.3 to 0.4 Nm.
8. Put the cable bushing over the cable tube and complete the work.  
Note that the use of a paint lock (e.g., Locktight 271 manufactured by Nihon Locktight K.K.) is recommended on the screw portion to prevent loosening of the cable tube..

The aforementioned work procedure is for the soldered type. In the case of the crimp-style type, Steps 1 and 3 are changed as follows:

1. With regard to cables, the wire to be used should have a conductor with a nominal cross-sectional area of 0.05 mm<sup>2</sup> (AWG #30) and 0.035 mm<sup>2</sup> (AWG #32) in a finished form suited to each size.
3. Crimp a suitable crimp terminal to the conductor portion of the cable, then fit into the molded terminal hole.

Should there be any points requiring clarification when using the connectors, please contact our Business or Technical Department.

## ◆ Assembly Jigs

Use of the following assembly jigs will simplify the job of disassembling and assembling the connectors at the time of wiring.

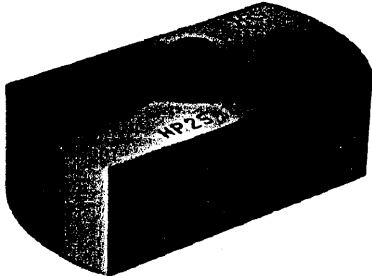

(HR25-7TP-01)

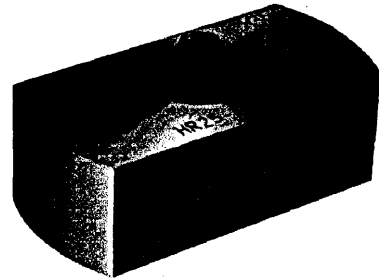

(HR25-7TJ-01)

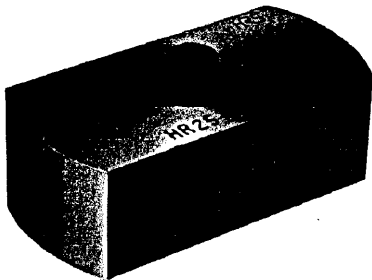

(HR25-7P-T01)

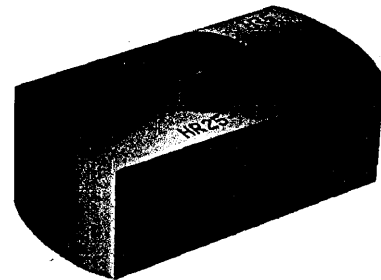

(HR25-7P-T02)

HRS No.	Product No.	Suitable Connectors and Uses
150-0082-0	HR25-7TP-T01	For HR25-7TP wiring and P shell unit tightening
150-0080-4	HR25-9TP-T01	For HR25-9TP wiring and P shell unit tightening
150-0089-9	HR25-7TJ-T01	For HR25-7TJ wiring and J shell unit tightening
150-0090-8	HR25-9TJ-T01	For HR25-9TJ wiring and J shell unit tightening
150-0085-8	HR25-7P-T01	For HR25-7P wiring
150-0086-0	HR25-9P-T01	For HR25-9P wiring
150-0087-3	HR25-7P-T02	For HR25-7P P shell unit tightening
150-0088-6	HR25-9P-T02	For HR25-9P P shell unit tightening



## Mounting Hole Dimensions Diagram

Mounting hole dimensions are indicated as viewed from the engagement side.

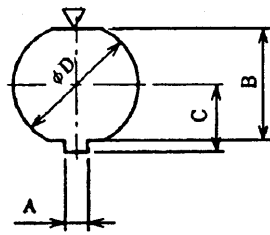

Screw lock type

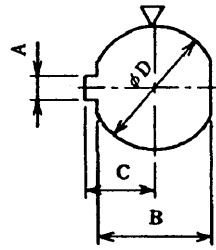

Push-pull lock type

Lock System	Screw Lock Type		Push-Pull Lock Type	
Shell Size	Size 7	Size 9	Size 7	Size 9
Diagram Symbol				
A	1.55 <sup>+0.05</sup> <sub>0</sub>	1.55 <sup>+0.05</sup> <sub>0</sub>	1.55 <sup>+0.05</sup> <sub>0</sub>	1.55 <sup>+0.05</sup> <sub>0</sub>
B	7.25 <sup>+0.03</sup> <sub>-0.02</sub>	9.25 <sup>+0.03</sup> <sub>-0.02</sub>	9.05 <sup>+0.03</sup> <sub>-0.02</sub>	11.05 <sup>+0.03</sup> <sub>-0.02</sub>
C	4.4 <sup>+0.1</sup> <sub>0</sub>	5.4 <sup>+0.1</sup> <sub>0</sub>	5.1 <sup>+0.1</sup> <sub>0</sub>	6.1 <sup>+0.1</sup> <sub>0</sub>
D	8 <sup>+0.05</sup> <sub>0</sub>	10 <sup>+0.05</sup> <sub>0</sub>	10 <sup>+0.05</sup> <sub>0</sub>	12 <sup>+0.05</sup> <sub>0</sub>
Mounting Panel Thickness	0.7~2	0.7~2	0.7~2	0.7~2

NOTE: The  $\nabla$  mark indicates the engagement guide key position.

## RECEPTACLE DIP POST CONFIGURATION DIMENSIONS

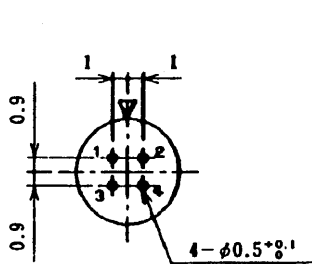

Size 7, 4 conductors

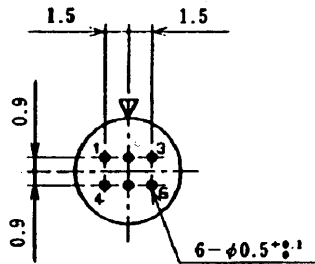

Size 7, 6 conductors

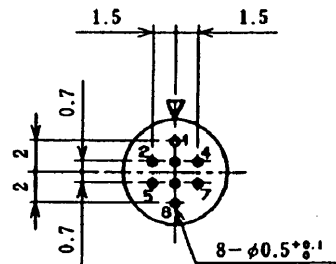

Size 7, 8 conductors

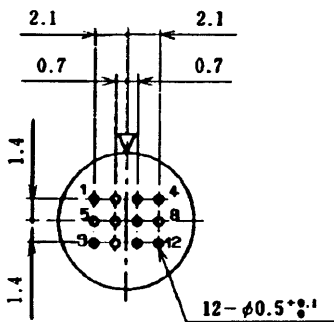

Size 9, 12 conductors

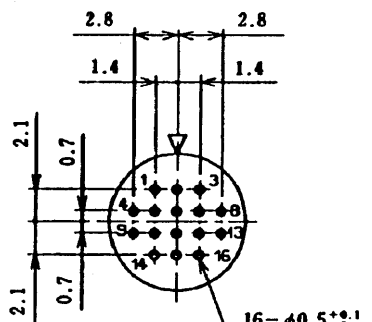

Size 9, 16 conductors

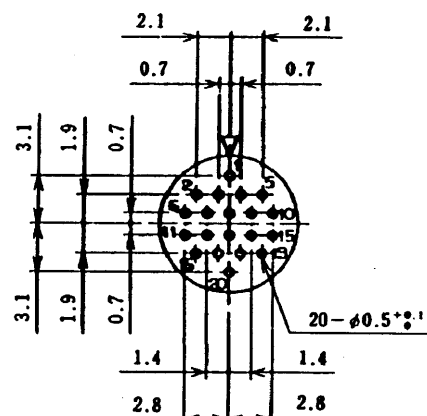

Size 9, 20 conductors

NOTE: 1. The above diagrams are viewed from the engagement side of the socket insert (i.e., the wiring side of the pin insert).

2. The  $\triangle$  mark of the above diagrams indicates the engagement guide key position.

3. A tolerance of  $\pm 0.05$  is recommended for dimensions without indication.