



Scanning Range

400 mm
(1800 mm max.)



70 mm max.



Features:

- LLK plastic fiber-optic cable
- Easy adaptation of fiber-optic cables
- Spot control for ease of alignment
 - Red sender light
 - high system reserve
 - Orange sender light
 - system reserve fallen below
 - Green sender light
 - test active
- Connecting cable or 4-pin M8 plug
- OFF delay adjustable from 0 - 100 ms
- Switching frequency 1.5 Hz
- Alarm output
- Test input to test the device and the complete system
- Overturn-protected sensitivity control (4-turn) with scale
- Light-/dark-switching selector
- CE / /

WLL 160

-E/-F 122

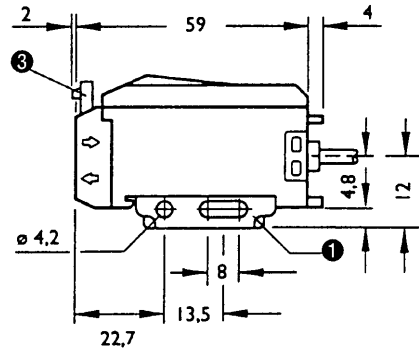

-E/-F 420

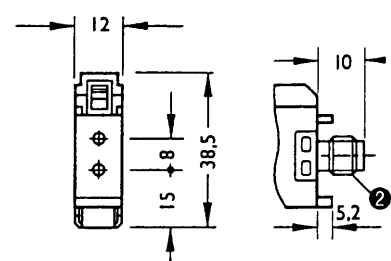

Dimensions in mm

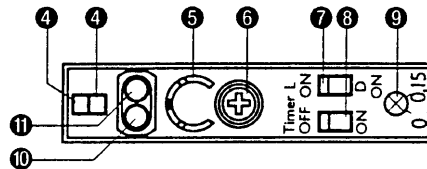

- 1 Mounting bracket (see Accessories)
- 2 M8 plug, 4-pin (for cable receptacles see Accessories)
- 3 Lock for fiber-optic cable
- 4 Indicator: correct seating of fiber-optic cable
- 5 Sensitivity scale
- 6 Sensitivity control (4-turn)
- 7 Light-/Dark-switching selector
- 8 ON/OFF switch: time delay
- 9 OFF delay: 0 to 100 ms
- 10 Green reception indicator (signals high system reserve)
- 11 Red reception indicator
(ON = intensity of received light above switching threshold)

Connection Diagram

WLL 160
-E/-F 122

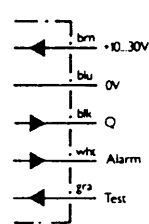

-E/-F 420

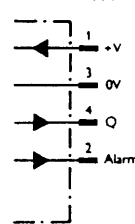

PNP

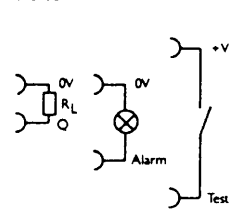

NPN

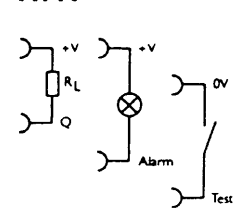

brn	blu	blk	wht	gra
brown	blue	black	white	gray

WLL 160 Photoelectric Switch with Fiber-optic Cables

	WLL 160 -E	-F
Part No.	see Selection Table	
Operating range	see Selection Table for LLK Fiber-optic Cables (page 69, 70)	
Supply voltage V_S¹⁾	10 to 30 V DC	
Current consumption (without load)	≤ 30 mA	
Ripple, max. ²⁾	5 V _{PP}	
Light sender		
Light reception without system reserve	LED, red/orange (spot control)	
Light reception with system reserve	LED, red (spot control)	
Light receiver switching mode	Light/Dark-switching, switch-selectable	
Light receiver sensitivity	adjustable (4-turn)	
Switching outputs, open collector	NPN	PNP
Signal voltage HIGH	approx. V_S	$V_S - (\leq 1,5 V)$
Signal voltage LOW	$\leq 1,5 V$	ca. 0 V
Output current max.	≤ 100 mA	
Alarm output (statical)	≤ 100 mA	
Time delay	OFF delay: 0 to 100 ms; can be switched on/off	
Test input ³⁾	Sender deactivated 0 V	Sender deactivated + V_S
Response time, switching frequency max.	$\leq 350 \mu s$; 1500/s	
VDE protection class⁴⁾	□	
Enclosure rating	IP 66	
Circuit protection ⁵⁾	A, B, C, D	
Ambient operating temperature	- 25 to + 55 °C	
Storage temperature	- 40 to + 70 °C	
Connecting cable	2 m, 5 x 0.2 mm ² , diam. 4.2 mm	
Equipment plug	M 8, 4-pin	
Weight	30 g with plug, 80 g with connecting cable	
1) Limit values 2) Must be within V_S tolerances 3) No test input on models with plug 4) Withstand voltage 50 V 5) A = Supply connections reverse-polarity protected B = In/Outputs reverse-polarity protected C = Interference pulse suppression D = Outputs overload and short-circuit protected		

Selection Table

	with connecting cable, 2 m	with M8 plug, 4-pin
NPN type	WLL 160-E 122	WLL 160-E 420
Part No.	6009 981	6009 982
PNP type	WLL 160-F 122	WLL 160-F 420
Part No.	6009 989	6009 990

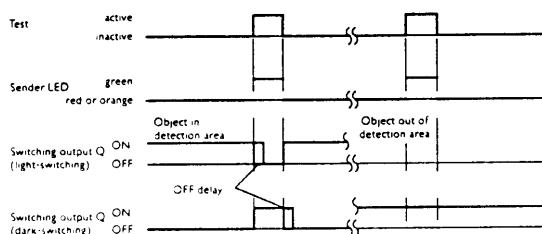

Diagram of Functions

