



# BRIGHT LED ELECTRONICS CORP.

## SURFACE MOUNT CHIP LED LAMP SPECIFICATION

●COMMODITY : SURFACE MOUNT CHIP LED LAMP

●DEVICE NUMBER : BL-HY033

PAGE: 2

●ELECTRICAL AND OPTICAL CHARACTERISTICS (Ta=25°C)

REVISION: 1.5

Chip			Lens Appearance	Absolute Maximum Rating				Electro-optical Data (At 20mA)				Viewing Angle 2θ 1/2 (deg)
Emitted Color	Peak Wave Length λ p(nm)	Dominant Wave Length λ d (nm)		Δ λ (nm)	Pd (mW)	If (mA)	Peak If(mA)	Vf(V)		Iv(mcd)		
								Typ.	Max.	Min	Typ.	
Yellow	583	585±5	Water Clear	32	100	30	100	2.2	2.6	3.7	7.0	120

Remark : Viewing angle is the Off-axis angle at which the luminous intensity is half the axial luminous intensity.

●ABSOLUTE MAXIMUM RATINGS (Ta=25°C)

Reverse Voltage .....	5V
Reverse Current (VR=5V) .....	≤100μA
Operating Temperature Range .....	-25°C ~ 80°C
Storage Temperature Range .....	-30°C ~ 85°C

●PACKAGE DIMENSIONS

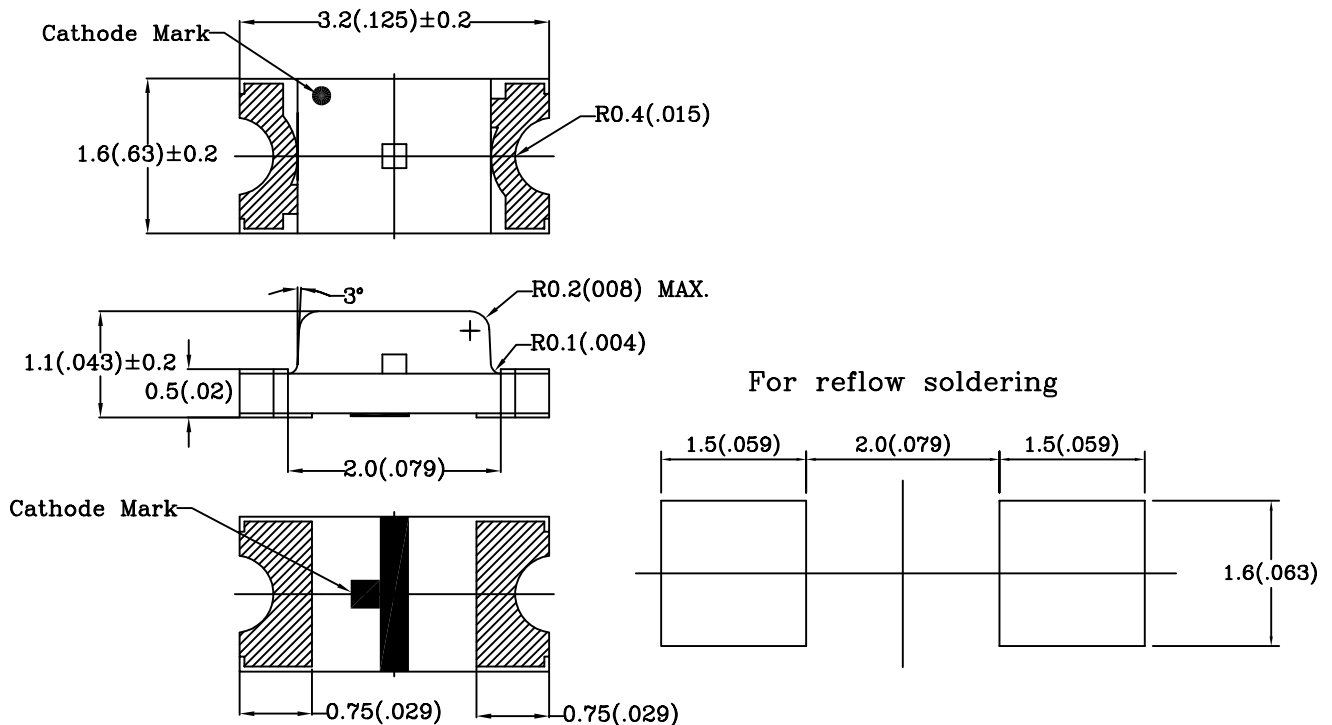

- NOTES: 1.All dimensions are in millimeters (inches).  
 2.Tolerance is ± 0.10mm (0.004) unless otherwise specified.  
 3.Specifications are subject to change without notice.  
 4.Condition for IFp is pulse of 1/10 duty and 0.1msec width.

# BRIGHT LED ELECTRONICS CORP.

## SURFACE MOUNT CHIP LED LAMP SPECIFICATION

● COMMODITY : SURFACE MOUNT CHIP LED LAMP

● DEVICE NUMBER : BL-HY033

● ELECTRICAL AND OPTICAL CHARACTERISTICS (Ta=25°C)

PAGE: 3

REVISION: 1.4

Fig.1 RELATIVE INTENSITY VS. WAVELENGTH

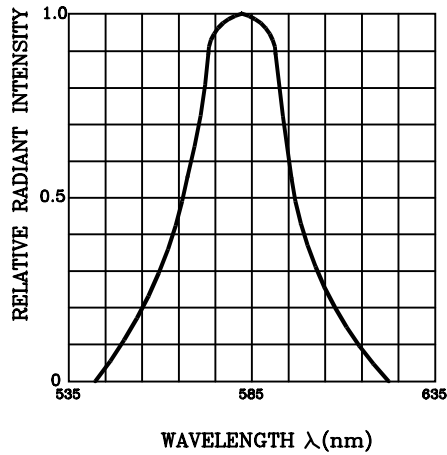

Fig.2 FORWARD CURRENT DERATING CURVE

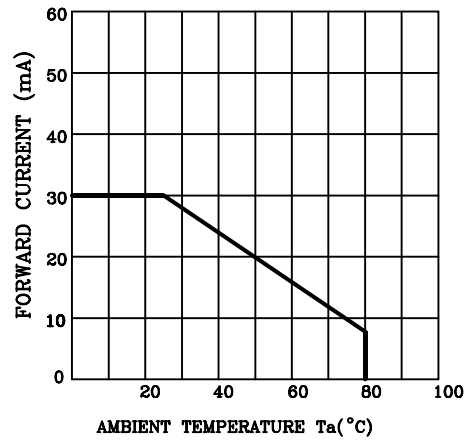

Fig.3 FORWARD CURRENT VS. FORWARD VOLTAGE

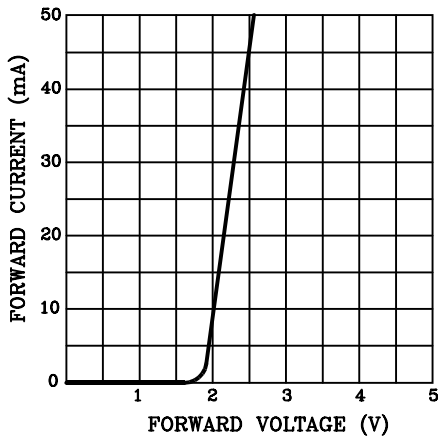

Fig.4 RELATIVE LUMINOUS INTENSITY VS. AMBIENT TEMPERATURE

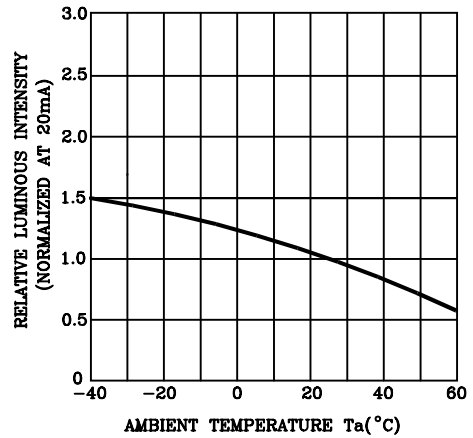

Fig.5 RELATIVE LUMINOUS INTENSITY VS. FORWARD CURRENT

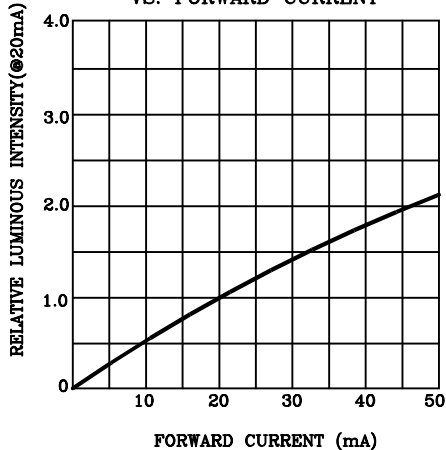
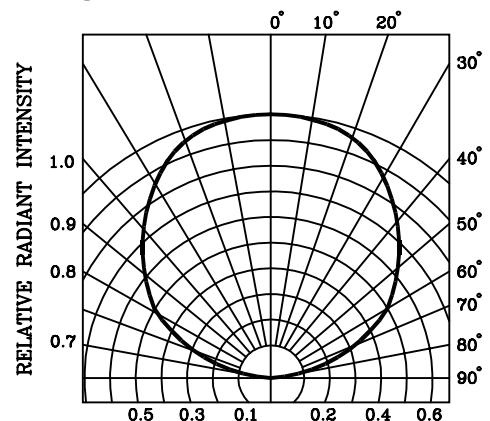

Fig.6 RADIATION DIAGRAM



# BRIGHT LED ELECTRONICS CORP.

## SURFACE MOUNT CHIP LED LAMP SPECIFICATION

● COMMODITY : SURFACE MOUNT CHIP LED LAMP

● DEVICE NUMBER : BL-HY033-TR

PAGE: 4

● ELECTRICAL AND OPTICAL CHARACTERISTICS (Ta=25°C)

REVISION: 1.1

ITEM	SYMBOL	SPECIFICATION			
		Minimum		Maximum	
		mm	inch	mm	inch
Tape Feed Hole Diameter (DIA)	D <sub>0</sub>	1.40	0.055	1.60	0.063
Feed Hole Location	E	1.65	0.064	1.85	0.073
Centers Line Dimensions Length Direction	F	3.45	0.135	3.55	0.139
Compartment Depth	K <sub>0</sub>	1.32	0.051	1.52	0.059
Compartment Pitch	P	3.90	0.153	4.10	0.161
Sprocket Hole Diameter	P <sub>0</sub>	3.90	0.153	4.10	0.161
Centers Line Dimensions Length Direction	P <sub>2</sub>	1.95	0.076	2.05	0.080
Carrier Tape Thickness	t	—	—	0.30	0.012
Carrier Tape Width	W	7.70	0.303	8.30	0.326
Flange Diameter	A	178.0	7.008	180.0	7.087
Hub Spindle Hole	C	12.50	0.492	13.50	0.531
Hub Diameter	D <sub>2</sub>	70.00	2.755	72.00	2.830
Fixing Tape Width	W <sub>1</sub>	5.25	0.206	5.35	0.210
Flange Space Between Flanges	T	12.50	0.492	13.50	0.531
Compartment Length	A <sub>0</sub>	1.84	0.072	2.04	0.080
Compartment Width	B <sub>0</sub>	3.43	0.135	3.63	0.143

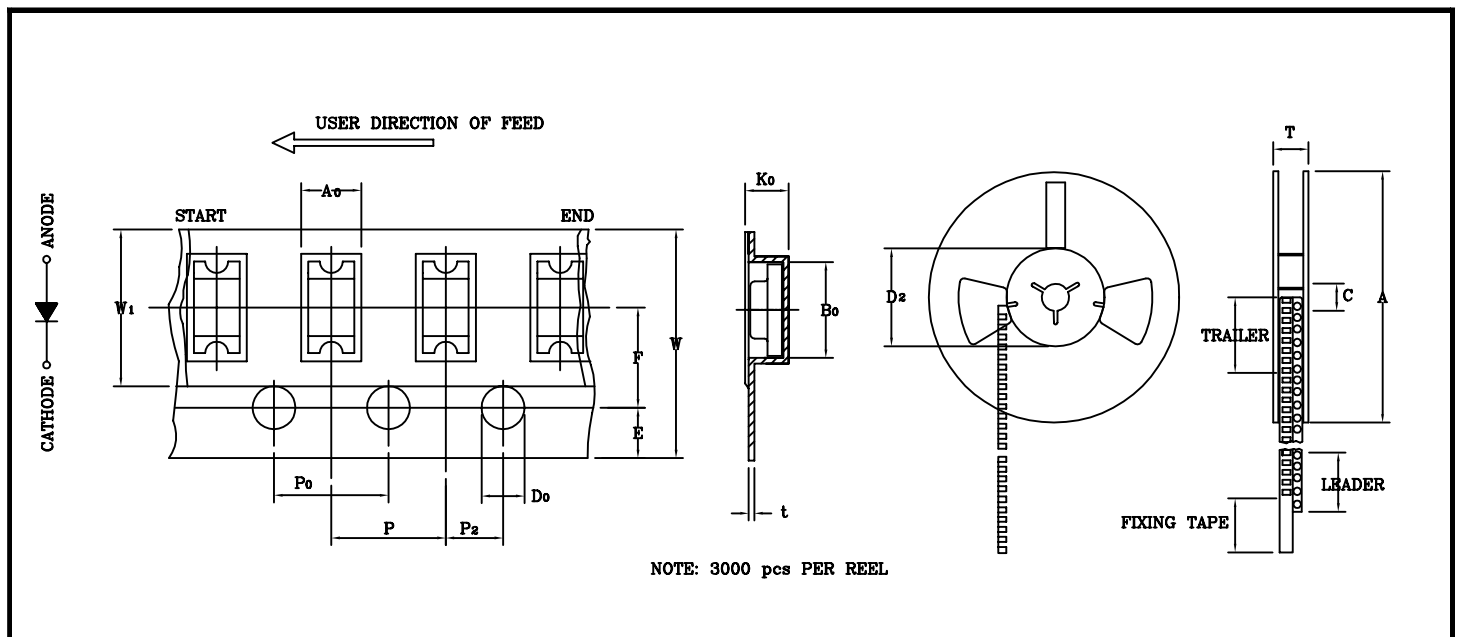

# BRIGHT LED ELECTRONICS CORP.

## SURFACE MOUNT CHIP LED LAMP SPECIFICATION

### RELIABILITY TEST

PAGE: 5

REVISION: 1.0

Classification	Test Item	Reference Standard	Test Conditions	Result
Endurance Test	Operation Life	MIL-STD-750:1026 MIL-STD-883:1005 JIS C 7021 :B-1	Connect with a power $I_f=20\text{mA}$ $T_a$ =Under room temperature Test time=1,000hrs	0/20
	High Temperature High Humidity Storage	MIL-STD-202:103B JIS C 7021 :B-11	$T_a=+65^\circ\text{C}\pm 5^\circ\text{C}$ RH=90%-95% Test time=240hrs	0/20
	High Temperature Storage	MIL-STD-883:1008 JIS C 7021 :B-10	High $T_a=+85^\circ\text{C}\pm 5^\circ\text{C}$ Test time=1,000hrs	0/20
	Low Temperature Storage	JIS-C-7021 :B-12	Low $T_a=-35^\circ\text{C}\pm 5^\circ\text{C}$ Test time=1,000hrs	0/20
Environmental Test	Temperature Cycling	MIL-STD-202:107D MIL-STD-750:1051 MIL-STD-883:1010 JIS C 7021 :A-4	$-35^\circ\text{C} \sim +25^\circ\text{C} \sim +85^\circ\text{C} \sim +25^\circ\text{C}$ 60min 20min 60min 20min Test Time=5cycle	0/20
	Thermal Shock	MIL-STD-202:107D MIL-STD-750:1051 MIL-STD-883:1011	$-35^\circ\text{C}\pm 5^\circ\text{C} \sim +85^\circ\text{C}\pm 5^\circ\text{C}$ 20min 20min Test Time=10cycle	0/20
	Solder Resistance	MIL-STD-202:201A MIL-STD-750:2031 JIS C 7021 :A-1	Preheating : $140^\circ\text{C} - 160^\circ\text{C}$ , within 2 minutes. Operation heating : $235^\circ\text{C}$ (Max.), within 10seconds. (Max.)	0/20

### JUDGMENT CRITERIA OF FAILURE FOR THE RELIABILITY

Measuring items	Symbol	Measuring conditions	Judgement criteria for failure
Forward voltage	$V_F$ ( V )	$I_f=20\text{mA}$	Over $U_x1.2$
Reverse current	$I_r$ ( $\mu\text{A}$ )	$V_r=5\text{V}$	Over $U_x2$
Luminous intensity	$I_v$ ( mcd )	$I_f=20\text{mA}$	Below $SX0.5$

Note: 1.U means the upper limit of specified characteristics. S means initial value.

2.Measurment shall be taken between 2 hours and after the test pieces have been returned to normal ambient conditions after completion of each test.

# BRIGHT LED ELECTRONICS CORP.

## SURFACE MOUNT CHIP LED LAMP SPECIFICATION

PAGE: 6

REVISION: 1.0

### 1. SOLDERING:

#### ● Manual Of Soldering

The temperature of the iron tip should not be higher than 300°C (572°F) and Soldering within 3 seconds per solder-land is to be observed.

#### ● Reflow Soldering

Preheating : 140°C~160°C±5°C, within 2 minutes.

Operation heating : 235°C (MAX.) within 10 seconds.(Max)

Gradual Cooling (Avoid quenching).

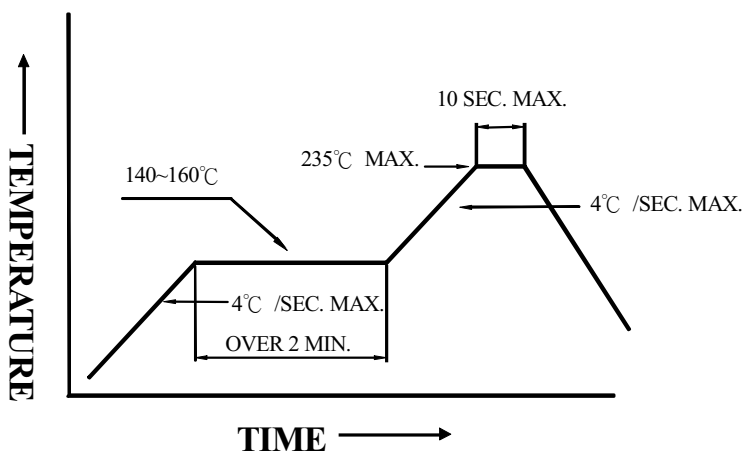

#### ● DIP soldering (Wave Soldering)

Preheating : 120°C~150°C, within 120~180 sec.

Operation heating : 245°C±5°C within 5 sec. 260°C (Max)

Gradual Cooling (Avoid quenching).

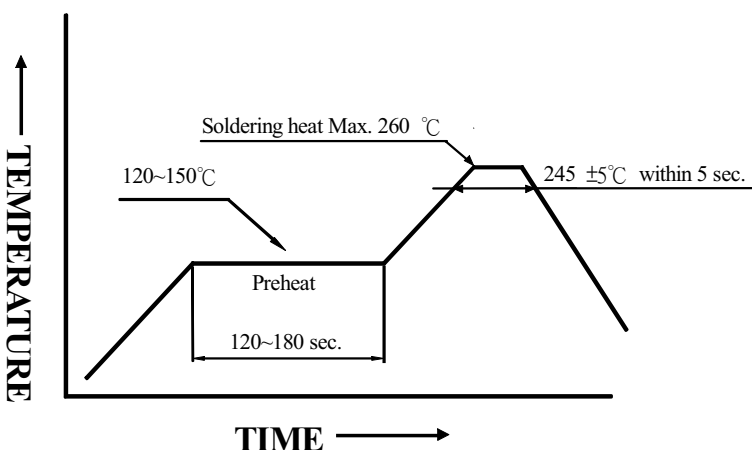

### 2. Handling :

Care must be taken not to cause to the epoxy resin portion of BRIGHT LEDs while it is exposed to high temperature.

Care must be taken not rub the epoxy resin portion of BRIGHT LEDs with hard or sharp article such as the sand blast and the metal hook.

# BRIGHT LED ELECTRONICS CORP.

## SURFACE MOUNT CHIP LED LAMP SPECIFICATION

PAGE: 7

REVISION: 1.0

### 3. Notes for designing:

Care must be taken to provide the current limiting resistor in the circuit so as to drive the BRIGHT LEDs within the rated figures. Also, caution should be taken not to overload BRIGHT LEDs with instantaneous voltage at the turning ON and OFF of the circuit.

When using the pulse drive care must be taken to keep the average current within the rated figures. Also, the circuit should be designed so as to be subjected to reverse voltage when turning off the BRIGHT LEDs.

### 4. Storage:

In order to avoid the absorption of moisture, it is recommended to solder BRIGHT LEDs as soon as possible after unpacking the sealed envelope.

If the envelope is still packed, to store it in the environment as following:

(1) Temperature : 5°C-30°C (41°F) Humidity : RH 60% Max.

(2) After this bag is opened, devices that will be applied to infrared reflow, vapor-phase reflow, or equivalent soldering process must be:

a. Completed within 24 hours.

b. Stored at less than 30% RH.

(3) Devices require baking before mounting, if:

(2) a or (2) b is not met.

(4) If baking is required, devices must be baked under below conditions:

12 hours at 60°C ± 3°C.

### 5. Package and Label of Products:

(1) Package: Products are packed in one bag of 3000 pcs (one taping reel) and a label is attached on each bag.

(2) Label:

