Features

- 3V to 28V DC operation voltage
- Chopper stabilized
- Wide operating voltage range
- Built-in power reverse protection
- Built-in voltage overshoot protection
- Output short circuit protection
- Open drain pre-driver
- SIP3 and SC59 (Commonly known as SOT23 in Asia)
: Available in "Green" Molding Compound (No Br, Sb)
- Lead Free Finish/RoHS Compliant (Note 1)

General Description

AH3761 is an integrated Hall effect latched sensor designed for electronic commutation of brush-less DC motor applications. The device includes an on-chip Hall voltage generator for magnetic sensing, a comparator that amplifies the Hall voltage, and a schmitt trigger to provide switching hysteresis for noise rejection, and open drain output. An internal bandgap regulator is used to provide temperature compensated supply voltage for internal circuits and allows a wide operating supply range.

If a magnetic flux density larger than threshold B_{op} , DO is turned on (low). The output state is held until a magnetic flux density reversal falls below B_{rp} causing DO to be turned off (high).

Application

- Brush-less DC Motor Commutation
- RPM Detection
- Consumer and industrial position sensor
- Flow meters

Typical Application Circuit

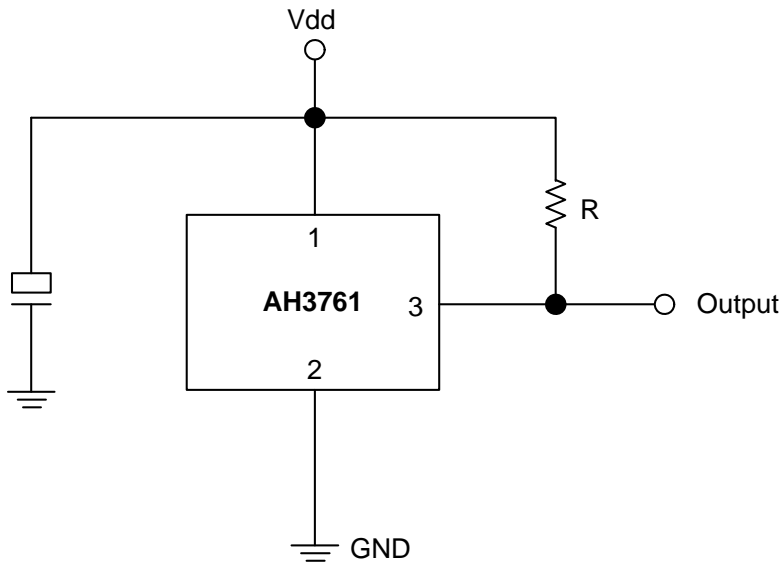

Ordering Information

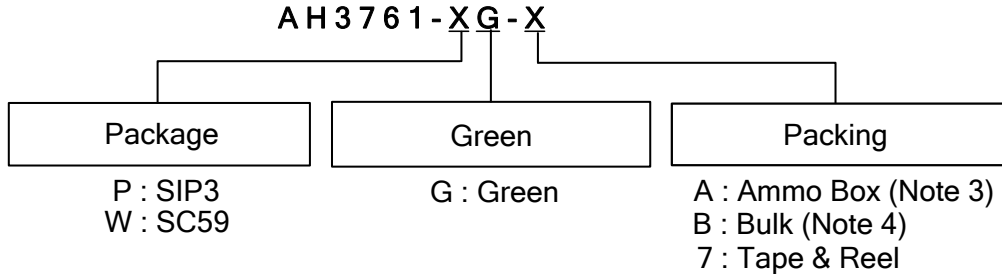

Device	Package Code	Packaging (Note 2)	Bulk		7" Tape and Reel		Ammo Box	
			Quantity	Part Number Suffix	Quantity	Part Number Suffix	Quantity	Part Number Suffix
AH3761-PG-A	P	SIP3	NA	NA	NA	NA	4000/Box	-A
AH3761-PG-B	P	SIP3	1000	-B	NA	NA	NA	NA
AH3761-WG-7	W	SC59	NA	NA	3000/Tape & Reel	-7	NA	NA



- Notes:
1. EU Directive 2002/95/EC (RoHS). All applicable RoHS exemptions applied. Please visit our website at http://www.diodes.com/products/lead_free.html
 2. Pad layout as shown on Diodes Inc. suggested pad layout document AP02001, which can be found on our website at <http://www.diodes.com/datasheets/ap02001.pdf>.
 3. Ammo Box is for SIP3 Spread Lead.
 4. Bulk is for SIP3 Straight Lead.

Pin Assignments

(1) SIP3

(2) SC59

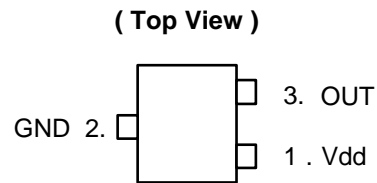
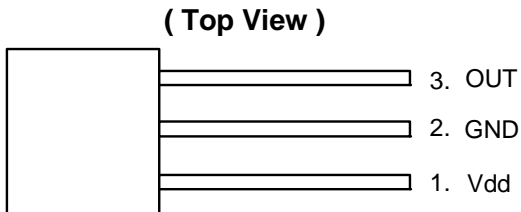

Pin Descriptions

Pin Name	P/I/O	Pin #	Description
Vdd	P	1	Positive Power Supply
GND	P	2	Ground
OUT	O	3	Output Pin

Block Diagram

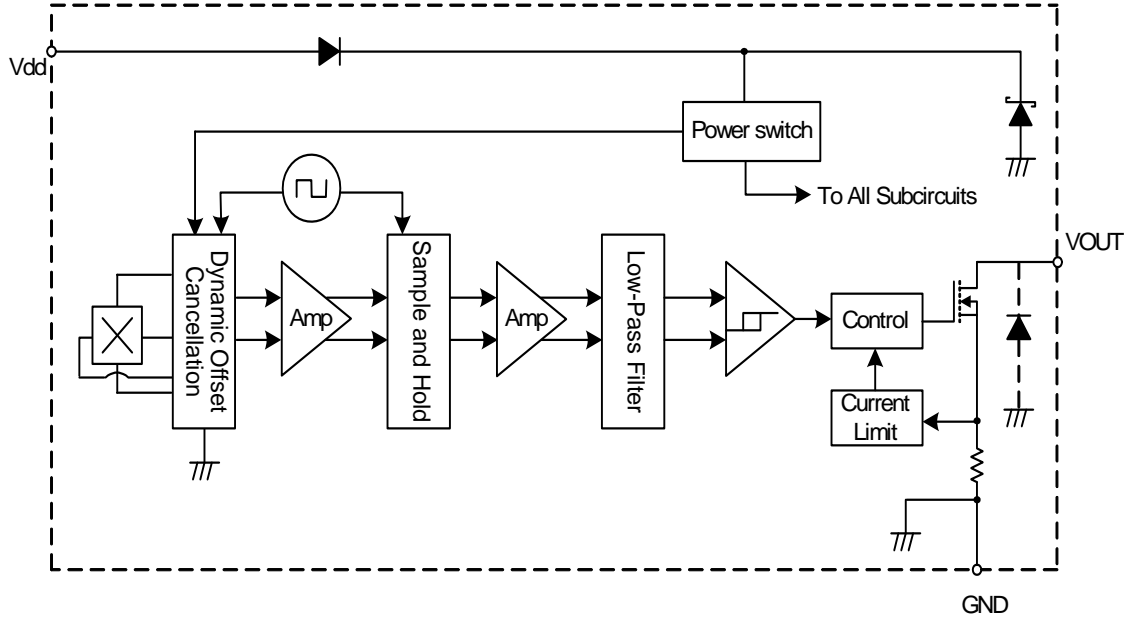

Absolute Maximum Ratings (at $T_A = 25^\circ\text{C}$)

Symbol	Characteristics	Values	Unit
Vdd	Supply Voltage	30	V
Vrdd	Reverse Battery Voltage	-30	V
B	Magnetic Flux Density	Unlimited	
V _{DS}	Output OFF Voltage	30	V
I _{O(peak)}	Output "On" Current (Peak)	100	mA
T _{ST}	Storage Temperature Range	-65~+150	°C
T _{J(MAX)}	Maximum Junction Temperature	150	°C
P _D	Package Power Dissipation	SIP3	550 mW
		SC59	230 mW
θ_{JC}	Thermal Resistance Junction to case	SIP3	227 °C/W
		SC59	543 °C/W

Recommended Operating Conditions

Symbol	Characteristic	Conditions	Min	Typ.	Max	Unit
Vdd	Supply Voltage	Operating	3	24	28	V
T _A	Operating Ambient Temperature	Operating	-40	-	125	°C

Electrical Characteristics (T_A = + 25°C, V_{dd} = 24V, Note 7)

Symbol	Characteristic	Test Conditions	Min	Typ.	Max	Unit
V _{o(sat)}	Output Saturation Voltage	I _{out} = 20mA, B > B _{op}	-	300	500	mV
I _{off}	Output Leakage Current	V _O = 24V, B < B _{op}	-	< 0.1	10	uA
I _{dd}	Supply Current	Output Open	-	4	6	mA
t _r	Output Rising Time	R _L = 10KΩ, C _L = 16pF	-	340	-	ns
t _f	Output Falling Time	R _L = 10KΩ, C _L = 16pF	-	20	-	ns
f _c	Chopping Frequency		-	300	-	KHz
I _{OM}	Output Current Limit	B > B _{op} (Note 5)	50	70	90	mA
t _{ST}	Start-up time of IC	V _{dd} > 3V, B > B _{op} (Note 6)	-	47	-	us

- Notes:
- The device will shut down operating after the output current I_O is over the output current limit I_{OM} for 160us (typically). The device will re-start up operating after resetting the supply voltage V_{dd}.
 - I_n initial power on time, the output state is kept in "High" in this start-up time of IC.
 - Typical data is at T_A = +25°C, V_{dd} = 24V and is design information only.

Magnetic Characteristics (T_A = + 25°C, V_{dd} = 3V to 28V, Note 8)

(1mT = 10Gauss)

Symbol	Parameter	Min	Typ.	Max	Unit
B _{op}	Operate Point	5	30	60	Gauss
B _{rp}	Release Point	-60	-30	-5	Gauss
B _{hys}	Hysteresis	-	60	-	Gauss

- Notes:
- Magnetic characteristics are for design information, which will vary with supply voltage, operating temperature and after soldering.

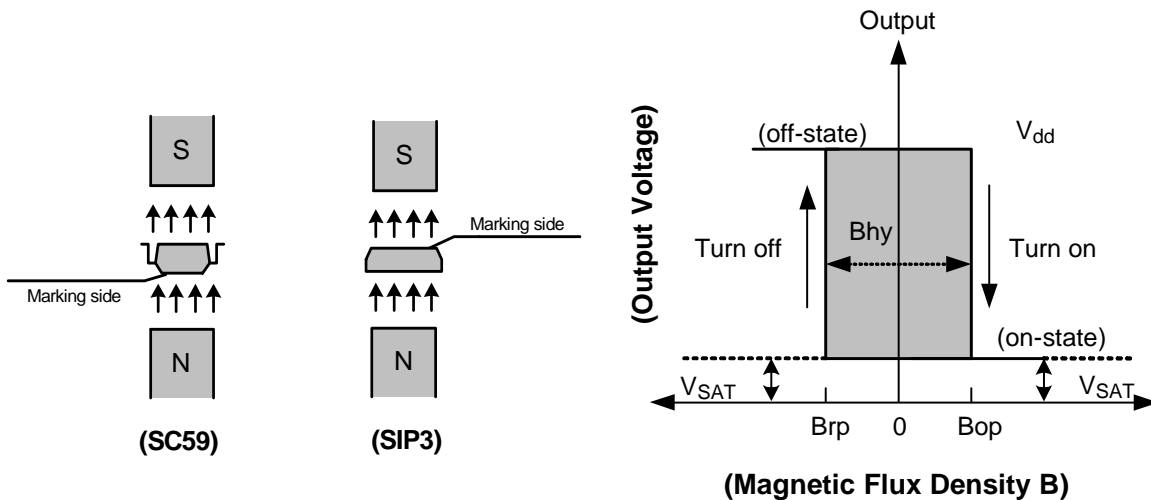

Performance Characteristics

(1) SIP3

T_A (°C)	25	50	60	70	80	85	90	95	100
P _D (mW)	550	440	396	352	308	286	264	242	220
T_A (°C)	105	110	115	120	125	130	135	140	150
P _D (mW)	198	176	154	132	110	88	66	44	0

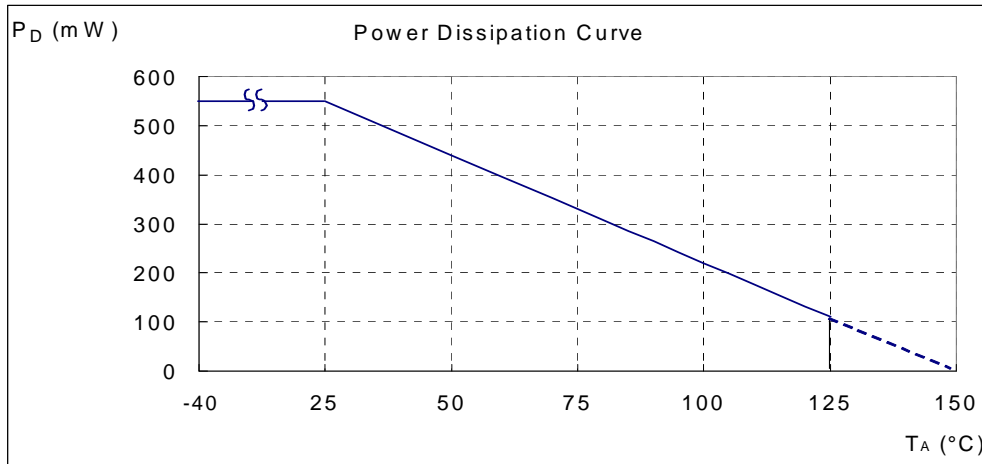

(2) SC59 (Commonly known as SOT23 in Asia)

T_A (°C)	25	50	60	70	80	90	100	110	120	125	130	140	150
P _D (mW)	230	184	166	147	129	110	92	74	55	46	37	18	0

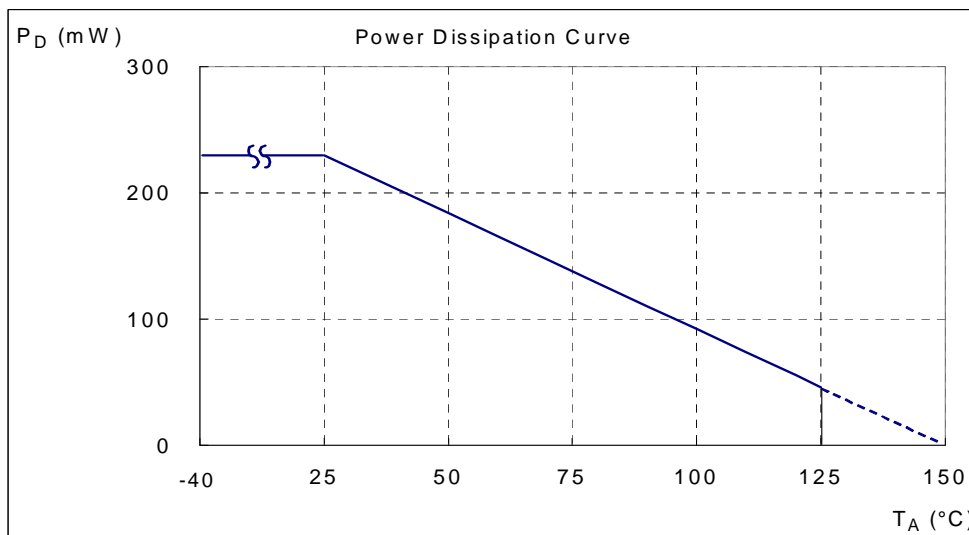

Marking Information

(1) SIP3

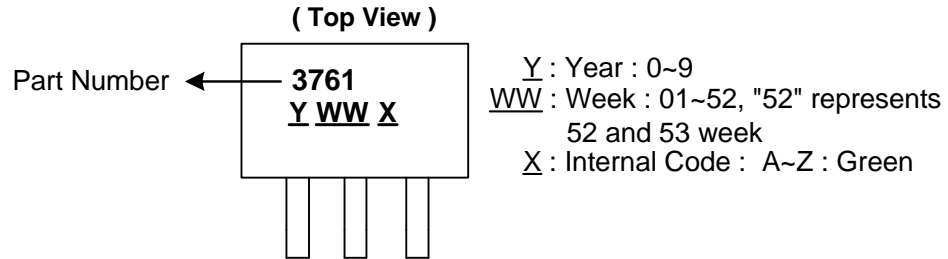

(2) SC59 (Commonly known as SOT23 in Asia)

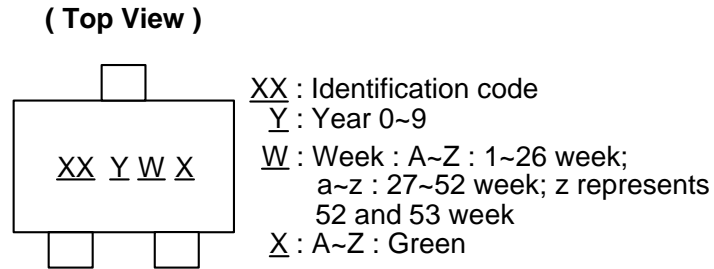

Part Number	Package	Identification Code
AH3761	SC59	P8

Package Information (All Dimensions in mm)

(1) Package Type: SIP3 for Bulk only

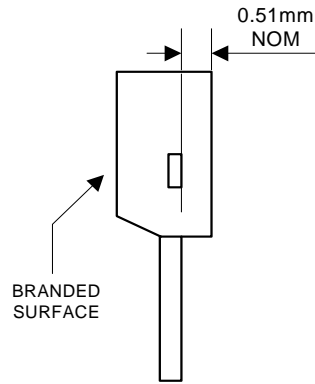

Active Area Depth

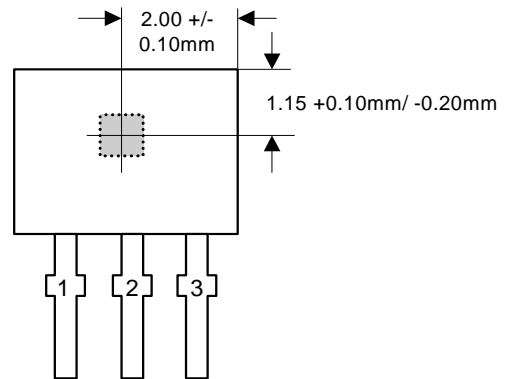

Sensor Location

Package Dimension

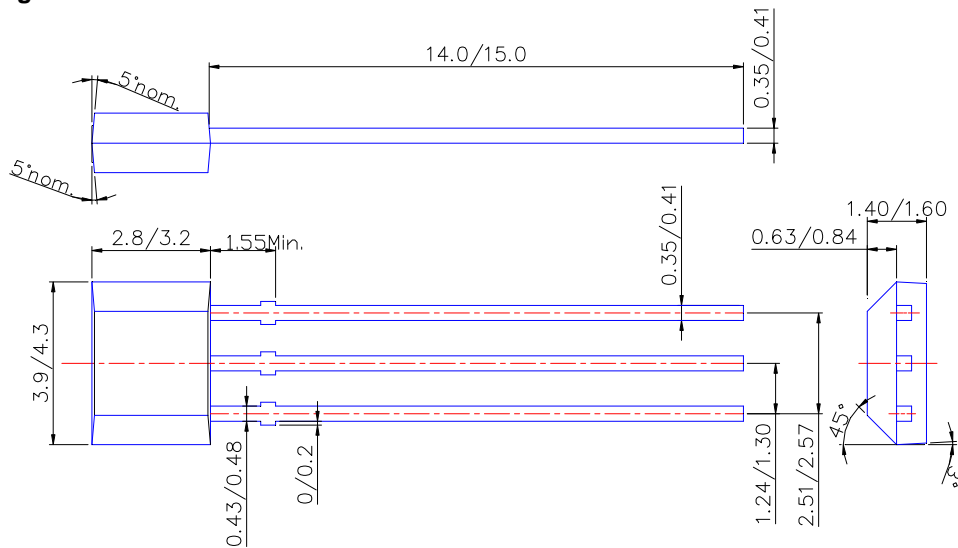

Package Information (Continued)

(2) Package Type: SIP3 for Ammo Pack-only

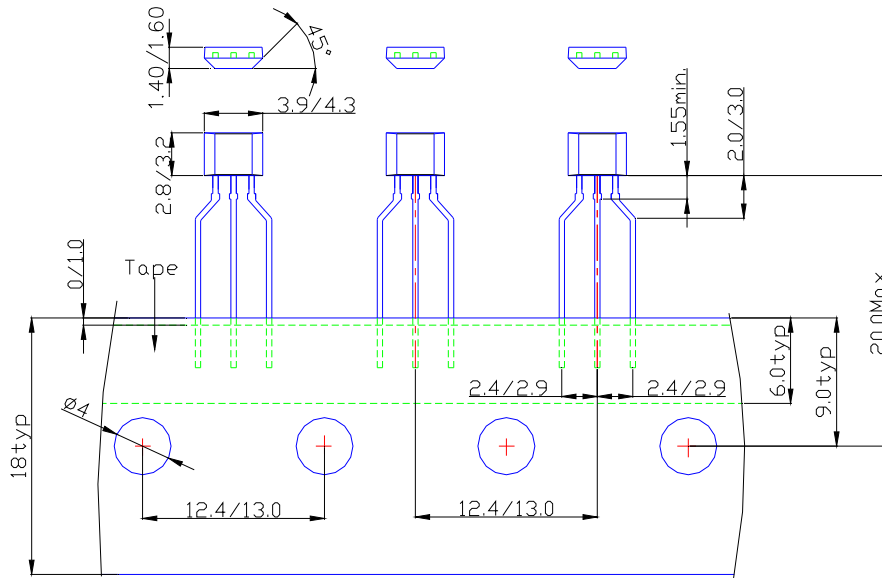

(3) SC59 (Commonly known as SOT23 in Asia)

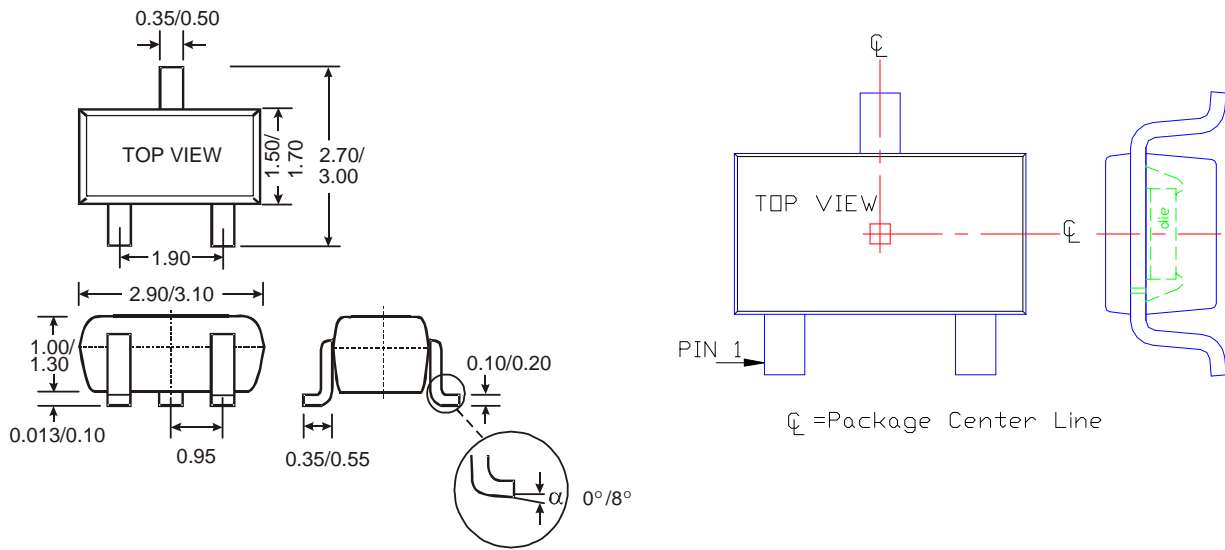

IMPORTANT NOTICE

DIODES INCORPORATED MAKES NO WARRANTY OF ANY KIND, EXPRESS OR IMPLIED, WITH REGARDS TO THIS DOCUMENT, INCLUDING, BUT NOT LIMITED TO, THE IMPLIED WARRANTIES OF MERCHANTABILITY AND FITNESS FOR A PARTICULAR PURPOSE (AND THEIR EQUIVALENTS UNDER THE LAWS OF ANY JURISDICTION).

Diodes Incorporated and its subsidiaries reserve the right to make modifications, enhancements, improvements, corrections or other changes without further notice to this document and any product described herein. Diodes Incorporated does not assume any liability arising out of the application or use of this document or any product described herein; neither does Diodes Incorporated convey any license under its patent or trademark rights, nor the rights of others. Any Customer or user of this document or products described herein in such applications shall assume all risks of such use and will agree to hold Diodes Incorporated and all the companies whose products are represented on Diodes Incorporated website, harmless against all damages.

Diodes Incorporated does not warrant or accept any liability whatsoever in respect of any products purchased through unauthorized sales channel.

Should Customers purchase or use Diodes Incorporated products for any unintended or unauthorized application, Customers shall indemnify and hold Diodes Incorporated and its representatives harmless against all claims, damages, expenses, and attorney fees arising out of, directly or indirectly, any claim of personal injury or death associated with such unintended or unauthorized application.

Products described herein may be covered by one or more United States, international or foreign patents pending. Product names and markings noted herein may also be covered by one or more United States, international or foreign trademarks.

LIFE SUPPORT

Diodes Incorporated products are specifically not authorized for use as critical components in life support devices or systems without the express written approval of the Chief Executive Officer of Diodes Incorporated. As used herein:

A. Life support devices or systems are devices or systems which:

1. are intended to implant into the body, or
2. support or sustain life and whose failure to perform when properly used in accordance with instructions for use provided in the labeling can be reasonably expected to result in significant injury to the user.

B. A critical component is any component in a life support device or system whose failure to perform can be reasonably expected to cause the failure of the life support device or to affect its safety or effectiveness.

Customers represent that they have all necessary expertise in the safety and regulatory ramifications of their life support devices or systems, and acknowledge and agree that they are solely responsible for all legal, regulatory and safety-related requirements concerning their products and any use of Diodes Incorporated products in such safety-critical, life support devices or systems, notwithstanding any devices- or systems-related information or support that may be provided by Diodes Incorporated. Further, Customers must fully indemnify Diodes Incorporated and its representatives against any damages arising out of the use of Diodes Incorporated products in such safety-critical, life support devices or systems.

Copyright © 2009, Diodes Incorporated

www.diodes.com