

SnapLED 150 LEDs

Technical Data



HP SunPower Series
HPWS-TH00
HPWS-FH00
HPWS-TL00
HPWS-FL00

Benefits

- Fewer LEDs Required
- Lower System Cost
- 3-Dimensional Array Design

Features

- High Flux Output
- Designed for High Current Operation
- Low Thermal Resistance
- Low Profile
- Solderless Mounting Technique
- Mounted on Formable Substrate
- Meets SAE/ECE/JIS Automotive Color Requirements

Applications

- Automotive Lighting
 - Rear Combination Lamps
 - Front Turn Signal Lamps
 - High Mount Stop Lamps
 - Indirect Lighting
- Solid State Lighting and Signaling

Description

Using Hewlett-Packard's patented solderless clinch technology, SnapLED 150 emitters are assembled onto a formable metal substrate which offers both styling flexibility and thermal conductivity unmatched by any other LED assembly.

The package's efficient optical design, high brightness material, and high current capability drastically reduce the number of LEDs required for lighting functions – thereby lowering the total cost.

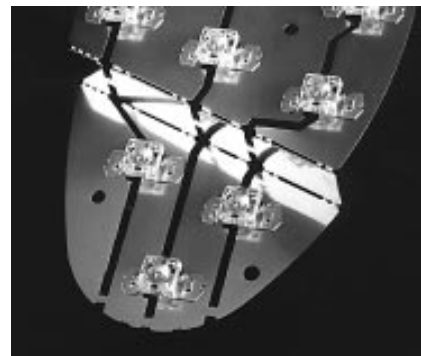

Selection Guide

Part Number	LED Color	Total Flux Φ_v (mlm) @ 150 mA ^[1] Min.	Total Included Angle $\theta_{0.90v}$ (Degrees) ^[2] Typ.
HPWS-TH00-00000	TS AlInGaP Red-Orange	6000	120
HPWS-FH00-00000			70
HPWS-TL00-00000	TS AlInGaP Amber	3000	120
HPWS-FL00-00000			70

Notes:

1. Φ_v is the total luminous flux output as measured with an integrating sphere after the device has stabilized ($R\theta_{j-a} = 100^\circ\text{C/W}$, $T_A = 25^\circ\text{C}$).
2. $\theta_{0.90v}$ is the included angle at which 90% of the total luminous flux is captured. See Figure 5.

Outline Drawing

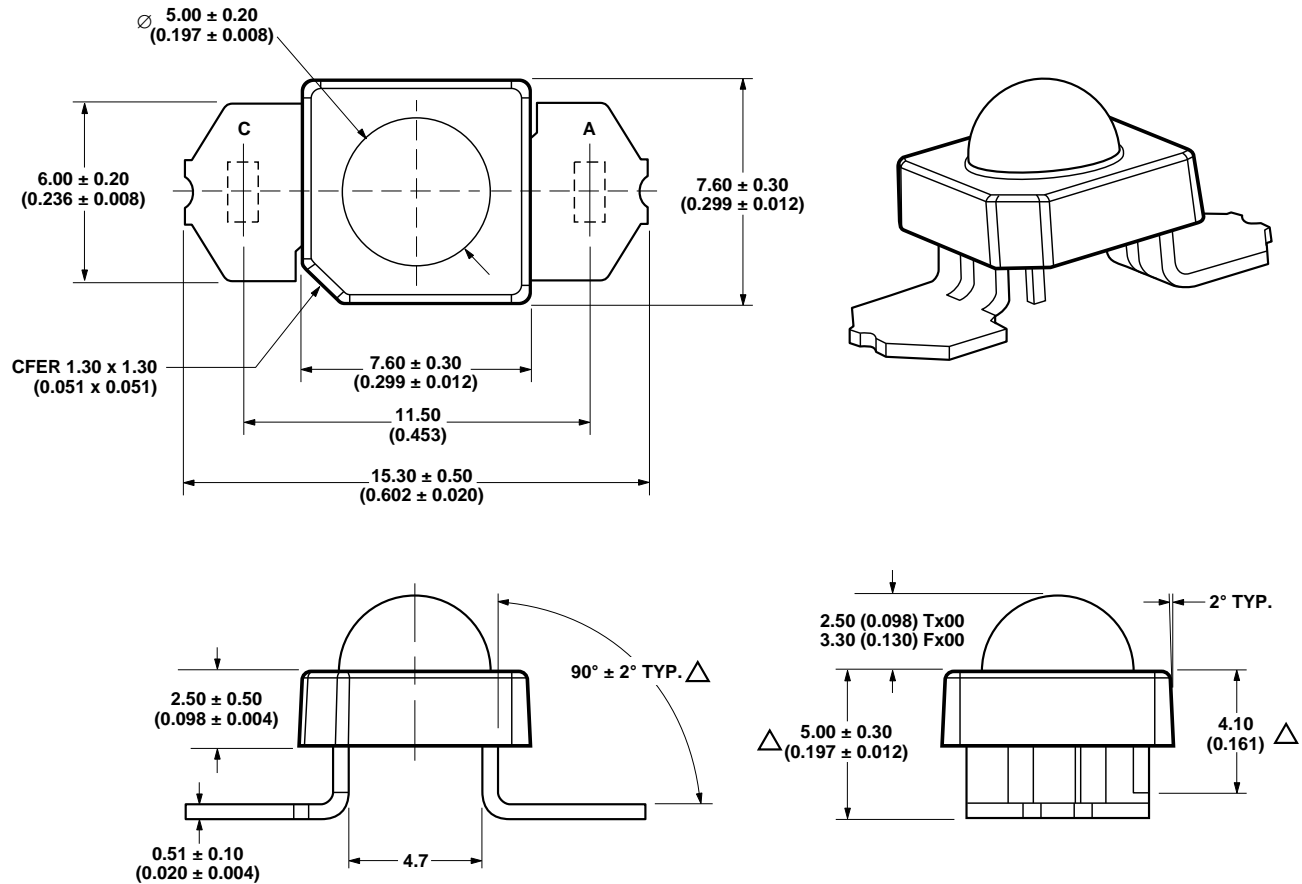

Notes:

1. Dimensions are in millimeters (inches).
2. Dimensions without tolerances are nominal.
3. Cathode lead is indicated with a "C" and anode lead is indicated with an "A."
4. Special characteristics are designated with a triangle.
5. Clinch joint locations shown in dashed lines on top view of part (11.50 mm spacing).

Absolute Maximum Ratings at $T_A = 25^\circ\text{C}$

Parameter	HPWS-Tx00/Fx00	Units
DC Forward Current ^[1,2]	150	mA
Pulsed Forward Current ^[3,4]	200	mA
Power Dissipation	475	mW
Reverse Voltage ($I_R = 100 \mu\text{A}$)	10	V
Operating Temperature Range	-40 to +100	$^\circ\text{C}$
Storage Temperature Range	-55 to +100	$^\circ\text{C}$
High Temperature Chamber	125 $^\circ\text{C}$, 2 hrs.	
LED Junction Temperature	125 $^\circ\text{C}$	

Notes:

1. Operation at currents below 20 mA is not recommended.
2. Derate linearly as shown in Figure 3a.
3. Amber only at simulated turn signal conditions of $f = 0.5 - 2$ Hz and 50% duty factor.
4. Derate linearly as shown in Figure 3b.

Optical Characteristics at $T_A = 25^\circ\text{C}$, $I_F = 150\text{ mA}$, $R_{\theta_{J-A}} = 100^\circ\text{C/W}$

Device Type	Total Flux Φ_V (mlm) ^[1]		Peak Wavelength λ_{peak} (nm) Typ.	Color, Dominant Wavelength λ_d (nm) ^[2] Typ.	Total Included Angle $\theta_{0.90V}$ (Degrees) ^[3] Typ.	Ratio of Luminous Intensity to Total Flux I_V (mcd)/ Φ_V (mlm) Typ.	Viewing Angle $2\theta_{1/2}$ (Degrees) Typ.
	Min.	Typ.					
HPWS-TH00	6000	630	621	120	0.6	85	
HPWS-FH00							70
HPWS-TL00	3000	596	594	120	0.6	85	
HPWS-FL00							70

Notes:

- Φ_V is the total luminous flux output as measured with an integrating sphere after the device has stabilized.
- The dominant wavelength is derived from the CIE Chromaticity Diagram and represents the perceived color of the device.
- $\theta_{0.90V}$ is the included angle at which 90% of the total luminous flux is captured. See Figure 5.

Electrical Characteristics at $T_A = 25^\circ\text{C}$

Device Type	Forward Voltage V_F (Volts) @ $I_F = 150\text{ mA}$			Reverse Breakdown V_R (Volts) @ $I_R = 100\ \mu\text{A}$		Capacitance C (pF) $V_F = 0$, $f = 1\text{ MHz}$ Typ.	Thermal Resistance $R_{\theta_{J-PIN}}$ ($^\circ\text{C/W}$) Typ.	Speed of Response τ_s (ns) ^[1] Typ.
	Min.	Typ.	Max.	Min.	Typ.			
HPWS-xH00	2.15	2.55	3.03	10	20	80	60	20
HPWS-xL00	2.15	2.65	3.15	10	20	80	75	20

Note:

- τ_s is the time constant, e^{-t/τ_s} .

Projected Luminous Flux Category Availability ^[1]

Part Number	LED Color	Total Flux Φ_V (mlm) @ 150 mA ^[2] Min.	1999	2000	2001	2002	2003	2004	2005
			HPWS-xH00-L4000	TS AlInGaP	6000	✓	✓	✓	✓
HPWS-xH00-M4000	Red-Orange	8000			✓	✓	✓	✓	✓
HPWS-xH00-N4000		10000				✓	✓	✓	✓
HPWS-xL00-F4000	TS AlInGaP	3000	✓	✓	✓	✓	✓	✓	✓
HPWS-xL00-G4000	Amber	3500	✓	✓	✓	✓	✓	✓	✓
HPWS-xL00-H4000		4000				✓	✓	✓	✓

Notes:

- LEDs will be available at the beginning of indicated years.
- Φ_V is the total luminous flux output as measured with an integrating sphere after the device has stabilized ($R_{\theta_{j-a}} = 100^\circ\text{C/W}$, $T_A = 25^\circ\text{C}$).

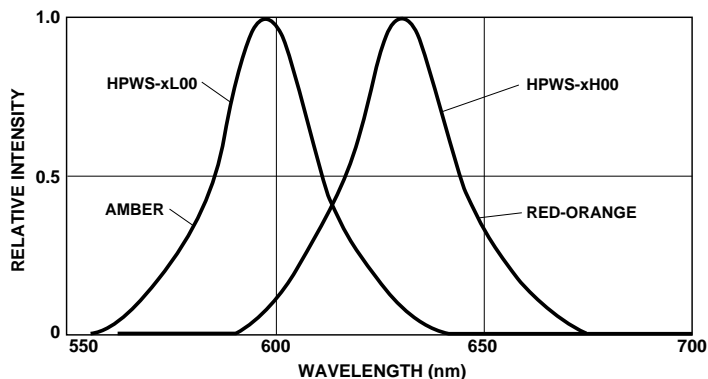

Figure 1. Relative Intensity vs. Wavelength.

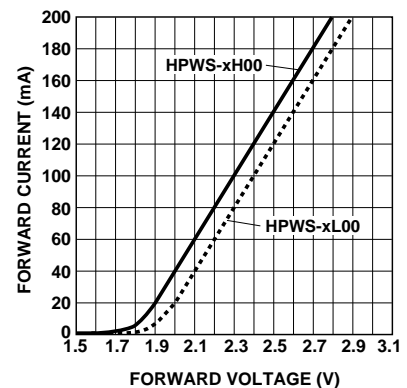

Figure 2. Forward Current vs. Forward Voltage.

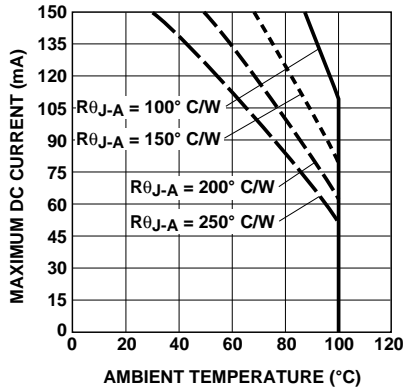

Figure 3a. HPWS-xx00 Maximum DC Forward Current vs. Ambient Temperature.

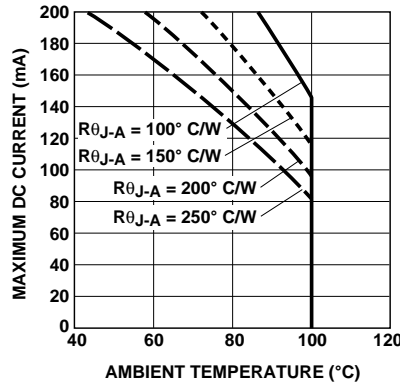

Figure 3b. HPWS-xx00 Maximum Pulsed Forward Current vs. Ambient Temperature.

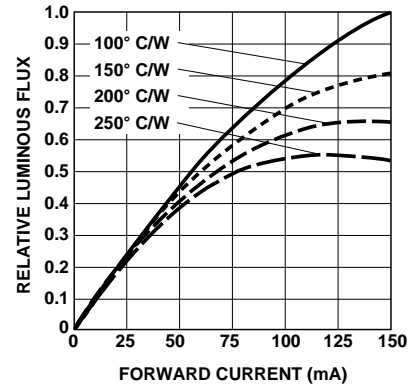

Figure 4. HPWS-xx00 Relative Luminous Flux vs. Forward Current.

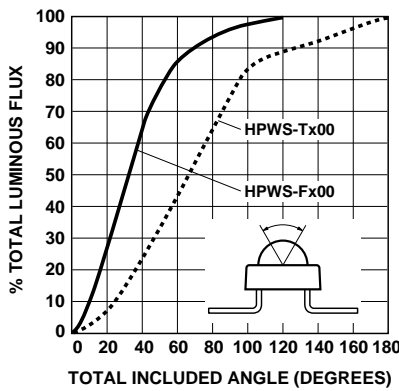

Figure 5. HPWS-xx00 Percent Total Luminous Flux vs. Total Included Angle.

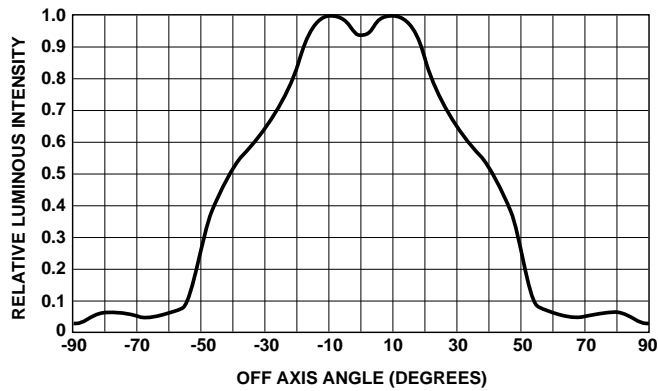

Figure 6a. HPWS-Tx00 Relative Intensity vs. Off Axis Angle.

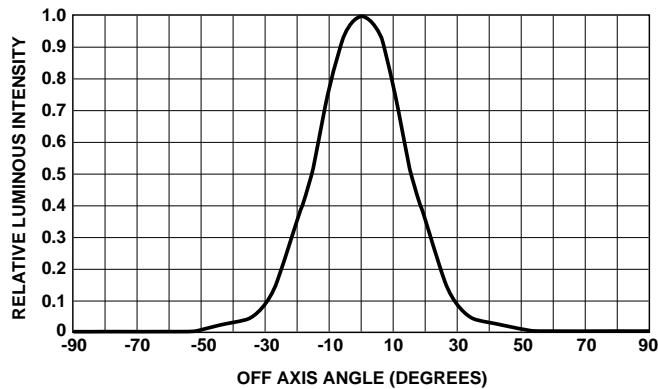

Figure 6b. HPWS-Fx00 Relative Intensity vs. Off Axis Angle.

For additional information, please refer to the HP AN 1149 Series.

www.hp.com/go/led

For technical assistance or the location of your nearest Hewlett-Packard sales office, distributor or representative call:

Americas/Canada: 1-800-235-0312 or 408-654-8675

Far East/Australasia: Call your local HP sales office.

Japan: (81 3) 3335-8152

Europe: Call your local HP sales office.

Data subject to change.

Copyright © 1999 Hewlett-Packard Co.

Obsoletes 5968-6846E (7/99)

5968-7807E (10/99)