

- Reduced board space ideal for high-density mounting (45% smaller than the surface area of G6B)
- Slim package: measures 6.5 W x 17.5 L x 12.5 H mm (0.26 x 0.69 x 0.49 in)
- Switches loads up to 5 A, 250 VAC/30 VDC
- Fully sealed construction allows automatic soldering and cleaning
- Long service life: up to 300,000 operations with a 2 A, 250 VAC/30 VDC load
- Rated for D150 pilot duty by UL, CSA
- Optional mounting socket simplifies relay installation and servicing of finished equipment

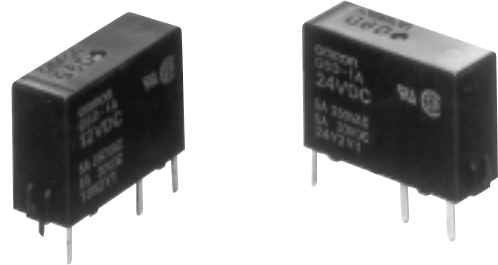

Ordering Information

To Order: Select the part number and add the desired coil voltage rating, (e.g., G6D-1A-DC12).

Type	Contact form	Terminal	Construction	Part number
Standard	SPST-NO	PCB	Fully sealed	G6D-1A

■ ACCESSORIES

Connecting Socket

Description	Part number
PCB mount socket for G6D relay	P6D-04P

Specifications

■ CONTACT DATA

Load	Resistive load (p.f. = 1)	Inductive load (p.f. = 0.40, L/R = 7 ms)
Rated load	5 A at 250 VAC, 30 VDC	2 A at 250 VAC, 30 VDC
Contact material	Ag alloy	
Carry current	5 A	
Max. operating voltage	250 VAC, 30 VDC	
Max. operating current	5 A	
Max. switching capacity	1,250 VA, 150 W	500 VA, 60 W
Min. permissible load	10 mA at 5 VDC	

COIL DATA

Rated voltage (VDC)	Rated current (mA)	Coil resistance (Ω)	Pick-up voltage	Dropout voltage	Maximum voltage	Power consumption (mW)
			% of rated voltage			
5	40	125	70% max.	10% min.	130% at 70°C (158°F)	Approx. 200
12	16.7	720				
24	8.3	2,880				

- Note: 1. The rated current and coil resistance are measured at a coil temperature of 23°C (73°F) with a tolerance of $\pm 10\%$.
 2. Operating characteristics are measured at a coil temperature of 23°C (73°F).
 3. The pick-up voltage is 75% or less of rated voltage if the relay is mounted upside down.

CHARACTERISTICS

Contact resistance		100 m Ω max.
Operate time		10 ms max. (mean value: approx. 4.30 ms)
Release time		10 ms max. (mean value: approx. 5.50 ms)
Bounce time	Operate	Mean value: approx. 1.20 ms
Operating frequency	Mechanical	18,000 operations/hour
	Electrical	1,800 operations/hour (under rated load)
Insulation resistance		1,000 M Ω min. (at 500 VDC)
Dielectric strength		3,000 VAC, 50/60 Hz for 1 minute between coil and contacts 750 VAC, 50/60 Hz for 1 minute between contacts of the same polarity
Surge withstand voltage		6,000 V, 1.20 x 50 μ s between coil and contacts
Vibration	Mechanical durability	10 to 55 Hz, 1.50 mm (0.06 in) double amplitude for 2 hours
	Malfunction durability	10 to 55 Hz, 1.50 mm (0.06 in) double amplitude for 5 minutes
Shock	Mechanical durability	1,000 m/s ² (approx. 100 G)
	Malfunction durability	100 m/s ² (approx. 10 G)
Ambient temperature	Operating	-25° to 70°C (-13° to 158°F)
Humidity		45% to 85% RH
Life expectancy	Mechanical	20 million operations min. (at operating frequency of 18,000 operations/hour)
	Electrical	See "Characteristic Data"
Weight		Approx. 3 g (0.10 oz)

Note: Data shown are of initial value.

CHARACTERISTIC DATA

Maximum switching capacity

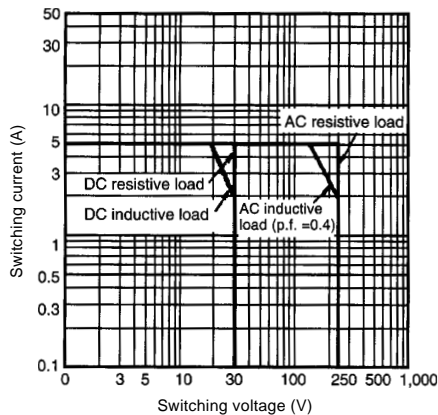

Life expectancy

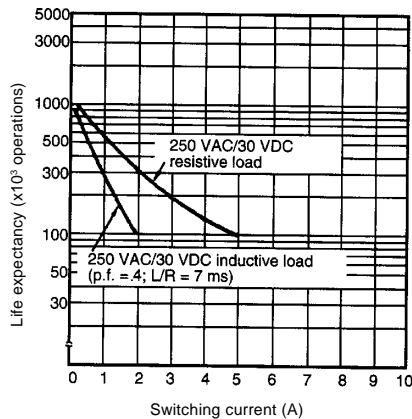

Ambient temperature vs. maximum voltage

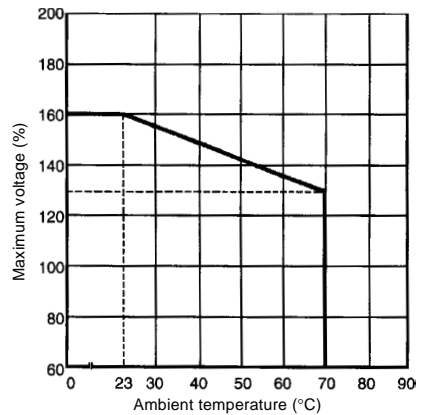

Dimensions

Unit: mm (inch)

■ RELAYS

G6D-1A

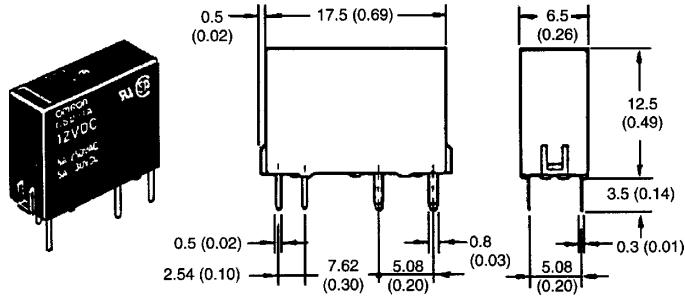

Terminal arrangement/ Internal connections

(Bottom view)

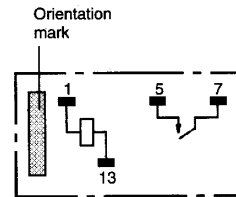

Mounting holes

(Bottom view)

Tolerance: ± 0.1 (0.04)

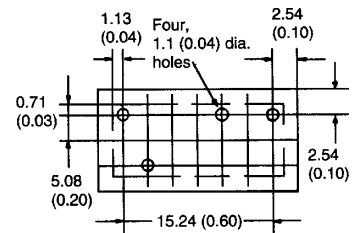

■ SOCKET

P6D-04P

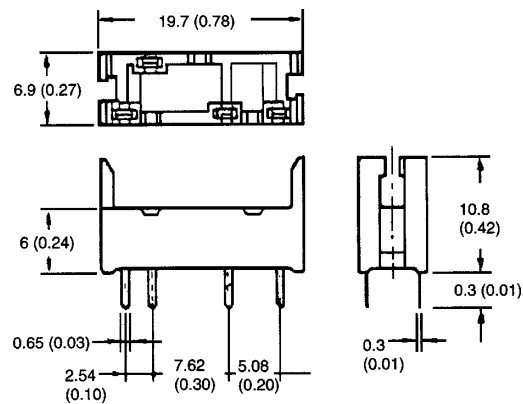
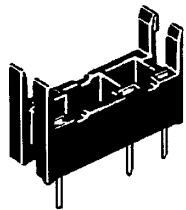

Mounting holes

(Bottom view)

Tolerance: ± 0.1 (0.04)

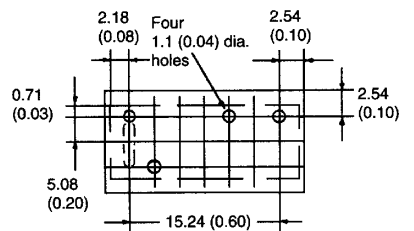

■ **APPROVALS**

UL (File No. E41515)/CSA (File No. LR31928)

Type	Contact form	Coil ratings	Contact ratings
G6D-1A	SPST-NO	5 to 24 VDC	5 A, 250 VAC (Resistive)
			5 A, 30 VDC (Resistive)
			1/10 HP, 120 VAC
			D150 Pilot Duty

- Note: 1. The rated values approved by each of the safety standards (e.g., UL, CSA, TUV) may be different from the performance characteristics individually defined in this catalog.
 2. In the interest of product improvement, specifications are subject to change.

Precautions

■ **SPACING BETWEEN RELAYS**

More than two relays can be closely mounted right side up as shown in the illustration below.

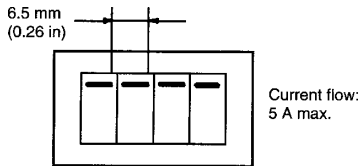

More than two relays can be closely mounted upside down as shown in the illustration below.

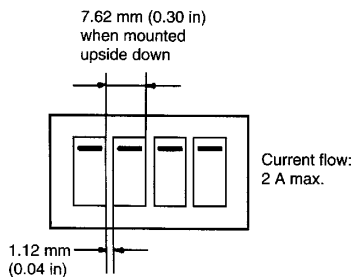

Note: The space between each relay required for heat radiation may vary with operating conditions.

■ **SOCKET MOUNTING**

When mounting the relay, insert it into the socket as vertically as possible so that the relay terminals contact securely with the contact pins on the socket.

The P6D-04P socket is flux-resistant. Do not wash the socket with water.

Remove the relay from the socket before soldering the socket to a PC board.

Mounting height

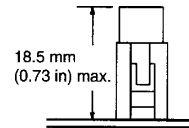

NOTE: DIMENSIONS ARE SHOWN IN MILLIMETERS. To convert millimeters to inches divide by 25.4.



OMRON ELECTRONICS, INC.
 One East Commerce Drive
 Schaumburg, IL 60173
1-800-55-OMRON

OMRON CANADA, INC.
 885 Milner Avenue
 Scarborough, Ontario M1B 5V8
416-286-6465