

AN3266FAP

Video luminance signal recording/playback processing IC

■ Overview

The AN3266FAP is a single chip IC in which the main signal processing part of VHS VCR luminance signal is integrated.

■ Features

- 5 V single power supply
- T2FP package

■ Applications

- VHS VCR, VHS video camera

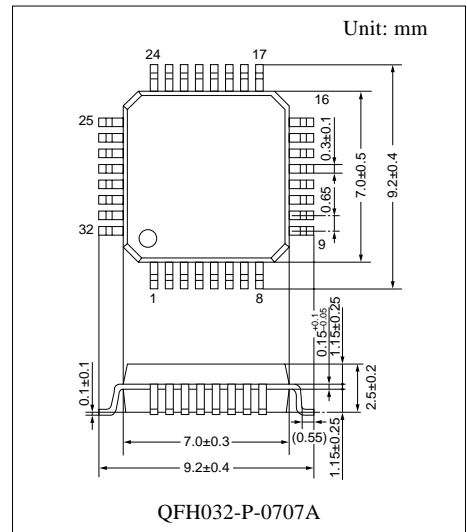

■ Block Diagram

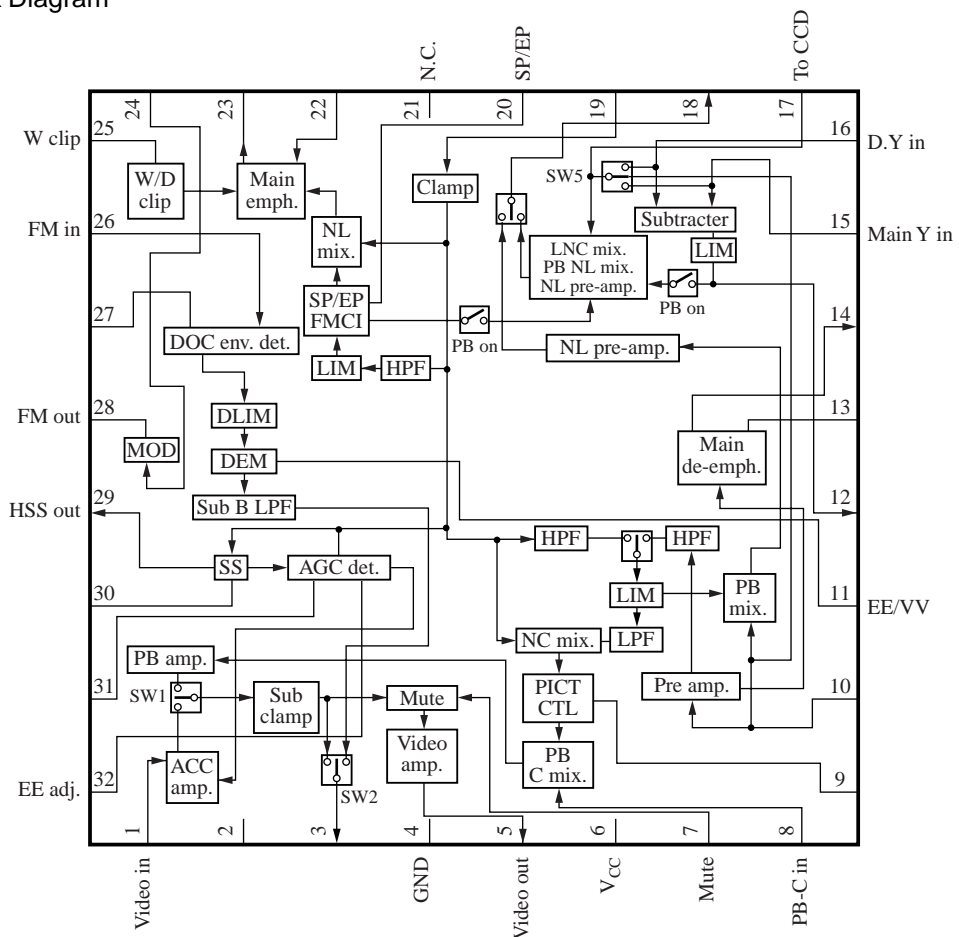

■ Pin Descriptions

Pin No.	Description	Pin No.	Description
1	Video in	17	To CCD out
2	Sub clamp det.	18	NL pre-emph. out
3	Sub clamp out (REC), Sub LPF out (PB)	19	Clamp in
4	GND	20	SP/EP select, FMCI CTL
5	Video out	21	N.C.
6	V _{CC}	22	NF input for main emph.
7	Mute CTL	23	Main emph. out
8	PB chroma in / DE off CTL	24	FM current in
9	Picture CTL	25	W clip CTL / LNC stop CTL
10	Signal input for main LPF	26	PB RF in
11	VV level adjust., EE / VV select.	27	Env. det.
12	LNC LIM out	28	REC FM out
13	Main de-emphasis	29	Sync. sepa. out
14	Main de-emphasis (out)	30	Sync. sepa. det.
15	Main Y sig. in	31	AGC det.
16	Delayed Y sig. in	32	EE adjust / NC off CTL

■ Absolute Maximum Ratings

Parameter	Symbol	Rating	Unit
Supply voltage	V _{CC}	6	V
Supply current	I _{CC}	68	mA
Power dissipation *2	P _D	208	mW
Operating ambient temperature *1	T _{opr}	-20 to +70	°C
Storage temperature *1	T _{stg}	-55 to +125	°C

Note) *1: Except for the operating ambient temperature and storage temperature, all ratings are for T_a = 25°C.









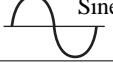

*2: The power dissipation shown is for the IC package in free air at T_a = 70°C.

P_D = 417 mW (T_a = 70°C) on mounting on a glass epoxy resin substrate of 50 × 50 × t0.8 mm³.

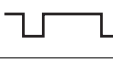



















■ Recommended Operating Range

Parameter	Symbol	Range	Unit
Supply voltage	V _{CC}	4.5 to 5.5	V





















■ Electrical Characteristics at $T_a = 25^\circ\text{C}$

Parameter	Symbol	Conditions	Min	Typ	Max	Unit
Circuit current (REC)	I_{CCR}	REC mode	30	42	54	mA
Circuit current (PB)	I_{CCP}	PB mode	38	50	62	mA
EE mode hold voltage	V_{EE}	$V_6 = \text{Variable}$	0	—	1.25	V
VV mode hold voltage	V_{VV}	$V_6 = \text{Variable}$	2.25	—	5	V
SP mode hold voltage	V_{SP}	$V_8 = \text{Variable}$	0	—	1.25	V
EP mode hold voltage	V_{EP}	$V_8 = \text{Variable}$	2.25	—	5	V
FMCI off mode hold voltage	V_{FM1}	$V_A = \text{Variable}$	2.25	—	3.25	V
FMCI on mode hold voltage	V_{FM2}	$V_A = \text{Variable}$	4.25	—	5	V
EDIT mode hold voltage at PB	V_{EDPB}	$V_1 = \text{Variable}$	0	—	1.25	V
Mute CTL Through mode hold voltage	$V_{THRU(PB)}$	$V_1 = \text{Variable}$	0	—	1	V
Mute CTL Quasi H mode hold voltage	V_{GRAY}	$V_B = \text{Variable}$	2	—	3	V
Mute CTL Quasi V mode hold voltage	V_{MUTE}	$V_3 = \text{Variable}$	4	—	5	V
EDIT mode hold voltage at REC	V_{EDREC}	$V_4 = \text{Variable}$	0	—	1.25	V
Off mode hold voltage at LNC	V_{LNC}	$V_9 = \text{Variable}$	0	—	1.25	V
Through mode hold voltage at EE	V_{THRU}	$V_3 = \text{Variable}$	0	—	1	V
Quasi H gray level offset	ΔV_5	PB mode	1.1	1.5	1.9	V
AGC output amplitude	V_{1-5}	 White 100% $V_{IN} = 1 \text{ V[p-p]}$	1.3	2.0	2.7	V[p-p]
AGC control sensitivity	ΔV_{1-5}	 White 100% $V_{IN} = 1 \text{ V[p-p]}$	0	0.3	1.2	dB
Video amp. frequency characteristics	f_{1-5}	 Sine wave 5 MHz / 100 kHz $V_{IN} = 250 \text{ mV[p-p]}$	-1.2	-0.5	0.5	dB
Main emphasis output level	V_{1-23}	 White 100% $V_{IN} = 1 \text{ V[p-p]}$	260	300	340	mV[p-p]
D-clip level	DV_{1-23}	—	45	55	65	%
Keyed pulse width	t_{W31}	 Sync. sig. $V_{IN} = 287 \text{ mV[p-p]}$	4.6	5.8	7.0	μs
SS minimum input sensitivity	S_{19}	 White 100% V_{IN} variable	—	—	450	mV[p-p]
SS pulse delay	t_{F29}	 $V_{IN} = 1 \text{ V[p-p]}$	460	660	860	ns
Over all gain for PB system	G_{10-5}	 White 100% $V_{IN} = 100 \text{ mV[p-p]}$	24	26	30	dB
Quasi V insertion step	ΔV_5	 White 100% $V_{IN} = 100 \text{ mV[p-p]}$	20	70	120	mV
Chroma amp. gain	G_{8-5}	 Sine wave $V_{IN} = 200 \text{ mV[p-p]}$	7.6	9.1	10.6	dB

















■ Electrical Characteristics at $T_a = 25^\circ\text{C}$ (continued)

Parameter	Symbol	Conditions	Min	Typ	Max	Unit
DE frequency characteristics 1 (0 dB)	$\Delta f_{10-18(1)}$	 Sine wave 500 kHz / 10 kHz $V_{IN} = 300 \text{ mV[p-p]}$	-0.5	0	1.0	dB
DE frequency characteristics 2 (0 dB)	$\Delta f_{10-18(2)}$	 Sine wave 2 MHz / 10 kHz $V_{IN} = 300 \text{ mV[p-p]}$	-0.5	0.15	1.15	dB
DE frequency characteristics 3 (-10 dB)	$\Delta f_{10-18(3)}$	 Sine wave 500 kHz / 10 kHz $V_{IN} = 94.9 \text{ mV[p-p]}$	-0.5	0.17	1.17	dB
DE frequency characteristics 4 (-10 dB)	$\Delta f_{10-18(4)}$	 Sine wave 2 MHz / 10 kHz $V_{IN} = 94.9 \text{ mV[p-p]}$	-0.5	0.45	1.45	dB
DE frequency characteristics 5 (-20 dB)	$\Delta f_{10-18(5)}$	 Sine wave 500 kHz / 10 kHz $V_{IN} = 30 \text{ mV[p-p]}$	-0.5	0.5	1.5	dB
DE frequency characteristics 6 (-20 dB)	$\Delta f_{10-18(6)}$	 Sine wave 2 MHz / 10 kHz $V_{IN} = 30 \text{ mV[p-p]}$	0.3	1.3	2.3	dB
DE frequency characteristics 7 (-30 dB)	$\Delta f_{10-18(7)}$	 Sine wave 500 kHz / 10 kHz $V_{IN} = 9.5 \text{ mV[p-p]}$	0	1.0	2.0	dB
DE frequency characteristics 8 (-30 dB)	$\Delta f_{10-18(8)}$	 Sine wave 2 MHz / 10 kHz $V_{IN} = 9.5 \text{ mV[p-p]}$	2.2	3.2	4.2	dB
DE off mode (-30 dB)	ΔG_{10-18}	 Sine wave 2 MHz $V_{IN} = 9.5 \text{ mV[p-p]}$	-4.2	-3.2	-2.2	dB
REC NL frequency characteristics 1 (0 dB)	$\Delta f_{19-23(1)}$	 Sine wave $V_{IN} = 1 \text{ V[p-p]}$ SP 500 kHz / 10 kHz	-0.5	0.5	1.5	dB
REC NL frequency characteristics 2 (0 dB)	$\Delta f_{19-23(2)}$	 Sine wave $V_{IN} = 1 \text{ V[p-p]}$ SP 1.5 MHz / 10 kHz	0	1.0	2.0	dB
REC NL frequency characteristics 3 (-10 dB)	$\Delta f_{19-23(3)}$	 Sine wave $V_{IN} = 316 \text{ mV[p-p]}$ SP 500 kHz / 10 kHz	0	1.0	2.0	dB
REC NL frequency characteristics 4 (-10 dB)	$\Delta f_{19-23(4)}$	 Sine wave $V_{IN} = 316 \text{ mV[p-p]}$ SP 1.5 MHz / 10 kHz	1.3	2.3	3.3	dB
REC NL frequency characteristics 5 (-20 dB)	$\Delta f_{19-23(5)}$	 Sine wave $V_{IN} = 100 \text{ mV[p-p]}$ SP 500 kHz / 10 kHz	0.1	1.1	2.1	dB
REC NL frequency characteristics 6 (-20 dB)	$\Delta f_{19-23(6)}$	 Sine wave $V_{IN} = 100 \text{ mV[p-p]}$ SP 1.5 MHz / 10 kHz	2.1	3.1	4.1	dB
REC NL frequency characteristics 7 (0 dB)	$\Delta f_{19-23(7)}$	 Sine wave $V_{IN} = 1 \text{ V[p-p]}$ EP 500 kHz / 10 kHz	0.3	1.3	2.3	dB
REC NL frequency characteristics 8 (0 dB)	$\Delta f_{19-23(8)}$	 Sine wave $V_{IN} = 1 \text{ V[p-p]}$ EP 1.5 MHz / 10 kHz	1.3	2.3	3.3	dB
REC NL frequency characteristics 9 (-10 dB)	$\Delta f_{19-23(9)}$	 Sine wave $V_{IN} = 316 \text{ mV[p-p]}$ EP 500 kHz / 10 kHz	1.3	2.3	3.3	dB
REC NL frequency characteristics 10 (-10 dB)	$\Delta f_{19-23(10)}$	 Sine wave $V_{IN} = 316 \text{ mV[p-p]}$ EP 1.5 MHz / 10 kHz	3.3	4.3	5.3	dB
REC NL frequency characteristics 11 (-20 dB)	$\Delta f_{19-23(11)}$	 Sine wave $V_{IN} = 100 \text{ mV[p-p]}$ EP 500 kHz / 10 kHz	1.6	2.6	3.6	dB
REC NL frequency characteristics 12 (-20 dB)	$\Delta f_{19-23(12)}$	 Sine wave $V_{IN} = 100 \text{ mV[p-p]}$ EP 1.5 MHz / 10 kHz	5.6	6.0	7.0	dB













■ Electrical Characteristics at $T_a = 25^\circ\text{C}$ (continued)

Parameter	Symbol	Conditions	Min	Typ	Max	Unit
PB NL frequency characteristics 1 (0 dB)	$\Delta f_{15-18(1)}$	 Sine wave $V_{IN} = 300\text{ mV[p-p]}$ SP 500 kHz / 10 kHz	-1.6	-0.6	0.4	dB
PB NL frequency characteristics 2 (0 dB)	$\Delta f_{15-18(2)}$	 Sine wave $V_{IN} = 300\text{ mV[p-p]}$ SP 1.5 MHz / 10 kHz	-2.0	-1.0	0	dB
PB NL frequency characteristics 3 (-10 dB)	$\Delta f_{15-18(3)}$	 Sine wave $V_{IN} = 94.9\text{ mV[p-p]}$ SP 500 kHz / 10 kHz	-2.1	-1.1	-0.1	dB
PB NL frequency characteristics 4 (-10 dB)	$\Delta f_{15-18(4)}$	 Sine wave $V_{IN} = 94.9\text{ mV[p-p]}$ SP 1.5 MHz / 10 kHz	-3.5	-2.5	-1.5	dB
PB NL frequency characteristics 5 (-20 dB)	$\Delta f_{15-18(5)}$	 Sine wave $V_{IN} = 30\text{ mV[p-p]}$ SP 500 kHz / 10 kHz	-2.2	-1.2	-0.2	dB
PB NL frequency characteristics 6 (-20 dB)	$\Delta f_{15-18(6)}$	 Sine wave $V_{IN} = 30\text{ mV[p-p]}$ SP 1.5 MHz / 10 kHz	-4.2	-3.2	-2.2	dB
PB NL frequency characteristics 7 (0 dB)	$\Delta f_{15-18(7)}$	 Sine wave $V_{IN} = 300\text{ mV[p-p]}$ EP 500 kHz / 10 kHz	-2.3	-1.3	-0.3	dB
PB NL frequency characteristics 8 (0 dB)	$\Delta f_{15-18(8)}$	 Sine wave $V_{IN} = 300\text{ mV[p-p]}$ EP 1.5 MHz / 10 kHz	-3.3	-2.3	-1.2	dB
PB NL frequency characteristics 9 (-10 dB)	$\Delta f_{15-18(9)}$	 Sine wave $V_{IN} = 94.9\text{ mV[p-p]}$ EP 500 kHz / 10 kHz	-3.3	-2.3	-1.3	dB
PB NL frequency characteristics 10 (-10 dB)	$\Delta f_{15-18(10)}$	 Sine wave $V_{IN} = 94.9\text{ mV[p-p]}$ EP 1.5 MHz / 10 kHz	-6.0	-5.0	-4.0	dB
PB NL frequency characteristics 11 (-20 dB)	$\Delta f_{15-18(11)}$	 Sine wave $V_{IN} = 30\text{ mV[p-p]}$ EP 500 kHz / 10 kHz	-3.5	-2.5	-1.5	dB
PB NL frequency characteristics 12 (-20 dB)	$\Delta f_{15-18(12)}$	 Sine wave $V_{IN} = 30\text{ mV[p-p]}$ EP 1.5 MHz / 10 kHz	-6.7	-5.7	-4.7	dB
NC frequency characteristics 1 (0 dB)	$\Delta f_{19-5(1)}$	 Sine wave $V_{IN} = 1\text{ V[p-p]}$ 1 MHz / 10 kHz	-1.4	-0.4	0.6	dB
NC frequency characteristics 2 (0 dB)	$\Delta f_{19-5(2)}$	 Sine wave $V_{IN} = 1\text{ V[p-p]}$ 2 MHz / 1 MHz	-1.1	-0.1	0.9	dB
NC frequency characteristics 3 (-10 dB)	$\Delta f_{19-5(3)}$	 Sine wave $V_{IN} = 316\text{ mV[p-p]}$ 1 MHz / 10 kHz	-2.0	-1.0	0	dB
NC frequency characteristics 4 (-10 dB)	$\Delta f_{19-5(4)}$	 Sine wave $V_{IN} = 316\text{ mV[p-p]}$ 2 MHz / 1 MHz	-0.8	0.2	1.2	dB
NC frequency characteristics 5 (-20 dB)	$\Delta f_{19-5(5)}$	 Sine wave $V_{IN} = 100\text{ mV[p-p]}$ 1 MHz / 10 kHz	-3.3	-2.3	-1.3	dB
NC frequency characteristics 6 (-20 dB)	$\Delta f_{19-5(6)}$	 Sine wave $V_{IN} = 100\text{ mV[p-p]}$ 2 MHz / 1 MHz	-0.5	0.5	1.5	dB
NC frequency characteristics 7 (-30 dB)	$\Delta f_{19-5(7)}$	 Sine wave $V_{IN} = 31.6\text{ mV[p-p]}$ 1 MHz / 10 kHz	-10	-6.3	-4.3	dB
NC frequency characteristics 8 (-30 dB)	$\Delta f_{19-5(8)}$	 Sine wave $V_{IN} = 31.6\text{ mV[p-p]}$ 2 MHz / 1 MHz	0.2	2.2	6.2	dB
NC off mode	ΔG_{19-5}	 Sine wave $V_{IN} = 31.6\text{ mV[p-p]}$ 1 MHz	4.3	6.3	10.0	dB

■ Electrical Characteristics at $T_a = 25^\circ\text{C}$ (continued)

Parameter	Symbol	Conditions	Min	Typ	Max	Unit
LNC attenuation level 1	$\Delta G_{15-18(1)}$	(19 input off)  Sine wave (19 input on) 10 kHz	-12.3	-9.3	-5	dB
LNC attenuation level 2	$\Delta G_{15-18(2)}$	(19 input off)  Sine wave (19 input on) 3 kHz	-8.1	-6.1	-3.1	dB
LNC off mode	ΔV_{15-18}	 Sine wave V_9 1.35 V 2.15 V 10 kHz	-1	0	1	dB
LNC LIM output amplitude	V_{LNC}	 Sine wave $V_{IN} = 300$ mV[p-p] 100 kHz	34	44	58	mV[p-p]
LNC LIM gain	G_{LNC}	 Sine wave $V_{IN} = 9.5$ mV[p-p] 100 kHz	3.7	6.7	8.7	mV[p-p]
Pic. cont. frequency characteristics 1 (forced)	$\Delta f_{19-5(1)}$	 Sine wave $V_{IN} = 500$ mV[p-p] 3 MHz / 100 kHz	4.9	5.9	7.4	dB
Pic. cont. frequency characteristics 2 (attenuated)	$\Delta f_{19-5(2)}$	 Sine wave $V_{IN} = 1$ V[p-p] 3 MHz / 100 kHz	-14	-11	-8	dB
FM oscillation output amplitude	V_{28}	$I_{IN} = 280$ μA	0.85	1.0	1.3	V[p-p]
FM oscillation secondary harmonic	$2f_{28}$	$I_{IN} = 280$ μA	—	—	-33	dB
FM oscillation frequency	f_{28}	$I_{IN} = 280$ μA	3.1	3.5	3.9	MHz
FM oscillation control sensitivity	β_{28}	$\frac{f(500 \mu\text{A}) - f(160 \mu\text{A})}{500 \mu\text{A} - 160 \mu\text{A}}$	11.5	13	15.0	MHz/ μA
FM carrier interleave 1	ΔV_{20-23}	 $V_{IN} = 5$ V[p-p]	1.35	2.35	3.35	mV[p-p]
DEM demodulation sensitivity 1	$S_{3(1)}$	 Sine wave $V_5 = 2.5$ V $V_{IN} = 350$ mV[p-p] $f_{IN} = 3$ MHz to 5 MHz	40	69	100	mV/MHz
DEM demodulation sensitivity 2	$S_{3(2)}$	 Sine wave $V_5 = 3.5$ V $V_{IN} = 350$ mV[p-p] $f_{IN} = 3$ MHz to 5 MHz	75	105	135	mV/MHz
DEM demodulation limit	Lf_{26-3}	 Sine wave $V_{IN} = 350$ mV[p-p]	7.5	—	—	MHz
DEM carrier leak	CL_{26-3}	 Sine wave $V_{IN} = 350$ mV[p-p] $f_{IN} = 2$ MHz \rightarrow 2 MHz / 4 MHz	—	—	-25	dB
Sub LPF frequency characteristics	Δf_{26-3}	 Sine wave f_{IN} $V_{IN} = 350$ mV[p-p]	-8	-6.2	-4.5	dB
DOC det. on	S_{26}	 Sine wave $f_{IN} = 4$ MHz	-20	-16	-11	dB
DOC det. off (hysteresis)	ΔS_{26}	 Sine wave $f_{IN} = 4$ MHz	0.2	1.5	6	dB
DOC offset	ΔV_{18}	 $V_{IN} = 350$ mV[p-p] or 0 mV[p-p] $f_{IN} = 4$ MHz	-15	0	15	mV[p-p]

■ Electrical Characteristics at $T_a = 25^\circ\text{C}$ (continued)

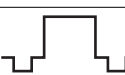
Parameter	Symbol	Conditions	Min	Typ	Max	Unit
DOC pulse width	t_{W18}	 $V_{IN} = 350 \text{ mV[p-p]}$ or 0 mV[p-p] $f_{IN} = 4 \text{ MHz}$	35.5	37.45	39.5	μs
DOC SW crosstalk	CT_{16-17}	 Sine wave DOC off $V_{IN} = 300 \text{ mV[p-p]}$ $f_{IN} = 100 \text{ kHz}$	—	—	-35	dB
Quasi V mute crosstalk	CT_{19-5}	 Sine wave $V_{IN} = 1 \text{ V[p-p]}$ $f_{IN} = 2 \text{ MHz}$	—	—	-35	dB
SW1 crosstalk 1	CT_{19-5}	 Sine wave $V_{IN} = 1 \text{ V[p-p]}$ $f_{IN} = 2 \text{ MHz}$	—	—	-40	dB
SW1 crosstalk 2	CT_{1-5}	 Sine wave $V_{IN} = 250 \text{ mV[p-p]}$ $f_{IN} = 2 \text{ MHz}$	—	—	-40	dB
SW2 crosstalk 1	CT_{26-3}	 Sine wave PB 2 MHz $V_{IN} = 350 \text{ mV[p-p]}$ REC 4 MHz	—	—	-40	dB
SW2 crosstalk 2	CT_{1-3}	 Sine wave $V_{IN} = 250 \text{ mV[p-p]}$ $f_{IN} = 2 \text{ MHz}$	—	—	-40	dB
SW5 crosstalk 1	CT_{15-18}	 Sine wave $V_{IN} = 250 \text{ mV[p-p]}$ $f_{IN} = 2 \text{ MHz}$	—	—	-40	dB
SW5 crosstalk 2	CT_{17-18}	 Sine wave $V_{IN} = 300 \text{ mV[p-p]}$ $f_{IN} = 2 \text{ MHz}$	—	—	-40	dB
White mute crosstalk	CT_{1-5}	 Sine wave $V_{IN} = 300 \text{ mV[p-p]}$ $f_{IN} = 2 \text{ MHz}$	—	—	-40	mV[p-p]
FM carrier interleave 2	ΔV_{20-18}	 Sine wave $V_{IN} = 5 \text{ V[0-p]}$ $f_{IN} = 2 \text{ MHz}$	4	7.5	1	mV
Pi cont. off mode	ΔG_{19-5}	 Sine wave $V_{IN} = 1 \text{ V[p-p]}$ $f_{IN} = 3 \text{ MHz}$	4.4	5.9	7.4	dB
SS pulse output amplitude	V_{29}	 White 100% $V_{IN} = 1 \text{ V[p-p]}$	4.3	—	—	V[p-p]

Application Circuit Example

