



TISP4072F3LM THRU TISP4082F3LM,  
TISP4125F3LM THRU TISP4180F3LM,  
TISP4240F3LM THRU TISP4380F3LM

**BIDIRECTIONAL THYRISTOR OVERVOLTAGE PROTECTORS**

**TISP4xxxF3LM Overvoltage Protector Series**

**Ion-Implanted Breakdown Region  
Precise and Stable Voltage  
Low Voltage Overshoot under Surge**

Device	V <sub>DRM</sub> V	V <sub>(BO)</sub> V
'4072	58	72
'4082	66	82
'4125	100	125
'4150	120	150
'4180	145	180
'4240	180	240
'4260	200	260
'4290	220	290
'4320	240	320
'4380	270	380

**Rated for International Surge Wave Shapes**

Waveshape	Standard	I <sub>TSP</sub> A
10/160 μs	FCC Part 68	60
0.5/700 μs	I3124	38
10/700 μs	ITU-T K.20/21	50
10/560 μs	FCC Part 68	45
10/1000 μs	REA PE-60	35

..... **UL Recognized Component**

**Description**

These devices are designed to limit overvoltages on the telephone line. Overvoltages are normally caused by a.c. power system or lightning flash disturbances which are induced or conducted on to the telephone line. A single device provides 2-point protection and is typically used for the protection of 2-wire telecommunication equipment (e.g. between the Ring to Tip wires for telephones and modems). Combinations of devices can be used for multi-point protection (e.g. 3-point protection between Ring, Tip and Ground).

The protector consists of a symmetrical voltage-triggered bidirectional thyristor. Overvoltages are initially clipped by breakdown clamping until the voltage rises to the breakover level, which causes the device to crowbar into a low-voltage on state. This low-voltage on state causes the current resulting from the overvoltage to be safely diverted through the device. The high crowbar holding current prevents d.c. latchup as the diverted current subsides.

**How To Order**

Device	Package	Carrier	For Standard Termination Finish Order As	For Lead Free Termination Finish Order As
TISP4xxxF3LM	Straight Lead DO-92 (LM)	Bulk Pack	TISP4xxxF3LM	TISP4xxxF3LM-S
		Tape and Reeled	TISP4xxxF3LMR	TISP4xxxF3LMR-S
	Formed Lead DO-92 (LMF)	Tape and Reeled	TISP4xxxF3LMFR	TISP4xxxF3LMFRS

Insert xxx value corresponding to protection voltages of 072, 082, 125 etc.

\*RoHS Directive 2002/95/EC Jan 27 2003 including Annex NOVEMBER 1997 - REVISED FEBRUARY 2005  
Specifications are subject to change without notice.  
Customers should verify actual device performance in their specific applications.

**LM Package (Top View)**

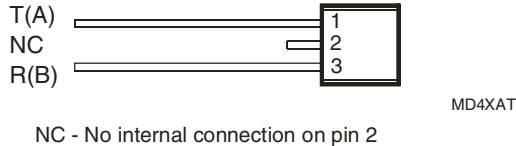

**LMF Package (LM Package with Formed Leads) (Top View)**

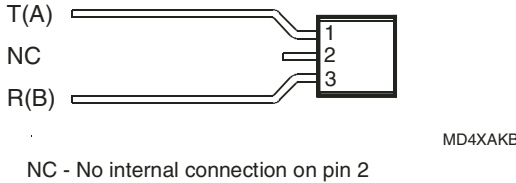

**Device Symbol**



Terminals T and R correspond to the alternative line designators of A and B

# TISP4xxxF3LM Overvoltage Protector Series

**BOURNS®**

## Description (continued)

This TISP4xxxF3LM range consists of ten voltage variants to meet various maximum system voltage levels (58 V to 270 V). They are guaranteed to voltage limit and withstand the listed international lightning surges in both polarities. These protection devices are supplied in a DO-92 (LM) cylindrical plastic package. The TISP4xxxF3LM is a straight lead DO-92 supplied in bulk pack and on tape and reeled. The TISP4xxxF3LMF is a formed lead DO-92 supplied only on tape and reeled.

## Absolute Maximum Ratings, $T_A = 25\text{ }^\circ\text{C}$ (Unless Otherwise Noted)

Rating	Symbol	Value	Unit	
Repetitive peak off-state voltage ( $0\text{ }^\circ\text{C} < T_J < 70\text{ }^\circ\text{C}$ )	'4072	$\pm 58$	V	
	'4082	$\pm 66$		
	'4125	$\pm 100$		
	'4150	$\pm 120$		
	'4180	$\pm 145$		
	'4240	$\pm 180$		
	'4260	$\pm 200$		
	'4290	$\pm 220$		
	'4320	$\pm 240$		
	'4380	$\pm 270$		
Non-repetitive peak on-state pulse current (see Notes 1, 2 and 3)	$I_{TSP}$		A	
2/10 $\mu\text{s}$ (FCC Part 68, 2/10 $\mu\text{s}$ voltage wave shape) excluding '4072 - '4082				175
8/20 $\mu\text{s}$ (ANSI C62.41, 1.2/50 $\mu\text{s}$ voltage wave shape) excluding '4072 - '4082				120
10/160 $\mu\text{s}$ (FCC Part 68, 10/160 $\mu\text{s}$ voltage wave shape)				60
5/200 $\mu\text{s}$ (VDE 0433, 2 kV, 10/700 $\mu\text{s}$ voltage wave shape)				50
0.2/310 $\mu\text{s}$ (I3124, 1.5 kV, 0.5/700 $\mu\text{s}$ voltage wave shape)				38
5/310 $\mu\text{s}$ (ITU-T K.20/21, 1.5 kV, 10/700 $\mu\text{s}$ voltage wave shape)				38
5/310 $\mu\text{s}$ (FTZ R12, 2 kV, 10/700 $\mu\text{s}$ voltage wave shape)				50
10/560 $\mu\text{s}$ (FCC Part 68, 10/560 $\mu\text{s}$ voltage wave shape)				45
10/1000 $\mu\text{s}$ (REA PE-60, 10/1000 $\mu\text{s}$ voltage wave shape)				35
2/10 $\mu\text{s}$ (FCC Part 68, 2/10 $\mu\text{s}$ voltage wave shape) '4072 - '4082 only				80
8/20 $\mu\text{s}$ (ANSI C62.41, 1.2/50 $\mu\text{s}$ voltage wave shape) '4072 - '4082 only	70			
Non-repetitive peak on-state current (see Notes 2 and 3)	$I_{TSM}$	4	A	
50/60 Hz, 1 s				
Initial rate of rise of on-state current, Linear current ramp, Maximum ramp value $< 38\text{ A}$	$di_T/dt$	250	A/ $\mu\text{s}$	
Junction temperature	$T_J$	-40 to +150	$^\circ\text{C}$	
Storage temperature range	$T_{stg}$	-55 to +150	$^\circ\text{C}$	

- NOTES: 1. Initially the TISP must be in thermal equilibrium with  $0\text{ }^\circ\text{C} < T_J < 70\text{ }^\circ\text{C}$ .  
 2. The surge may be repeated after the TISP returns to its initial conditions.  
 3. Above  $70\text{ }^\circ\text{C}$ , derate linearly to zero at  $150\text{ }^\circ\text{C}$  lead temperature.

# TISP4xxxF3LM Overvoltage Protector Series

**BOURNS®**

## Electrical Characteristics for R and T Terminals, $T_J = 25\text{ }^\circ\text{C}$ (Unless Otherwise Noted)

Parameter	Test Conditions	Min	Typ	Max	Unit	
$I_{\text{DRM}}$ Repetitive peak off-state current	$V_D = \pm V_{\text{DRM}}$ , $0\text{ }^\circ\text{C} < T_J < 70\text{ }^\circ\text{C}$			$\pm 10$	$\mu\text{A}$	
$V_{(\text{BO})}$ Breakover voltage	$dv/dt = \pm 250\text{ V/ms}$ , $R_{\text{SOURCE}} = 300\ \Omega$			±72 ±82 ±125 ±150 ±180 ±240 ±260 ±290 ±320 ±380	V	
$V_{(\text{BO})}$ Impulse breakover voltage	$dv/dt = \pm 1000\text{ V}/\mu\text{s}$ , $R_{\text{SOURCE}} = 50\ \Omega$ $di/dt < 20\text{ A}/\mu\text{s}$			±86 ±96 ±143 ±168 ±198 ±267 ±287 ±317 ±347 ±407	V	
$I_{(\text{BO})}$ Breakover current	$dv/dt = \pm 250\text{ V/ms}$ , $R_{\text{SOURCE}} = 300\ \Omega$	$\pm 0.15$		$\pm 0.6$	A	
$V_T$ On-state voltage	$I_T = \pm 5\text{ A}$ , $t_W = 100\ \mu\text{s}$			$\pm 3$	V	
$I_H$ Holding current	$I_T = \pm 5\text{ A}$ , $di/dt = -/+ 30\text{ mA/ms}$	$\pm 0.15$			A	
$dv/dt$ Critical rate of rise of off-state voltage	Linear voltage ramp, Maximum ramp value $< 0.85V_{\text{DRM}}$	$\pm 5$			$\text{kV}/\mu\text{s}$	
$I_D$ Off-state current	$V_D = \pm 50\text{ V}$			$\pm 10$	$\mu\text{A}$	
$C_{\text{off}}$ Off-state capacitance	$f = 100\text{ kHz}$ , $V_d = 1\text{ V r.m.s.}$ , $V_D = 0$ , $f = 100\text{ kHz}$ , $V_d = 1\text{ V r.m.s.}$ , $V_D = -50\text{ V}$			63 43 44 25 15 11	108 74 74 40 25 20	$\text{pF}$

## Thermal Characteristics

Parameter	Test Conditions	Min	Typ	Max	Unit
$R_{\theta\text{JA}}$ Junction to free air thermal resistance	EIA/JESD51-3 PCB mounted in an EIA/JESD51-2 enclosure			120	$^\circ\text{C}/\text{W}$

NOVEMBER 1997 - REVISED FEBRUARY 2005

Specifications are subject to change without notice.

Customers should verify actual device performance in their specific applications.

## Parameter Measurement Information

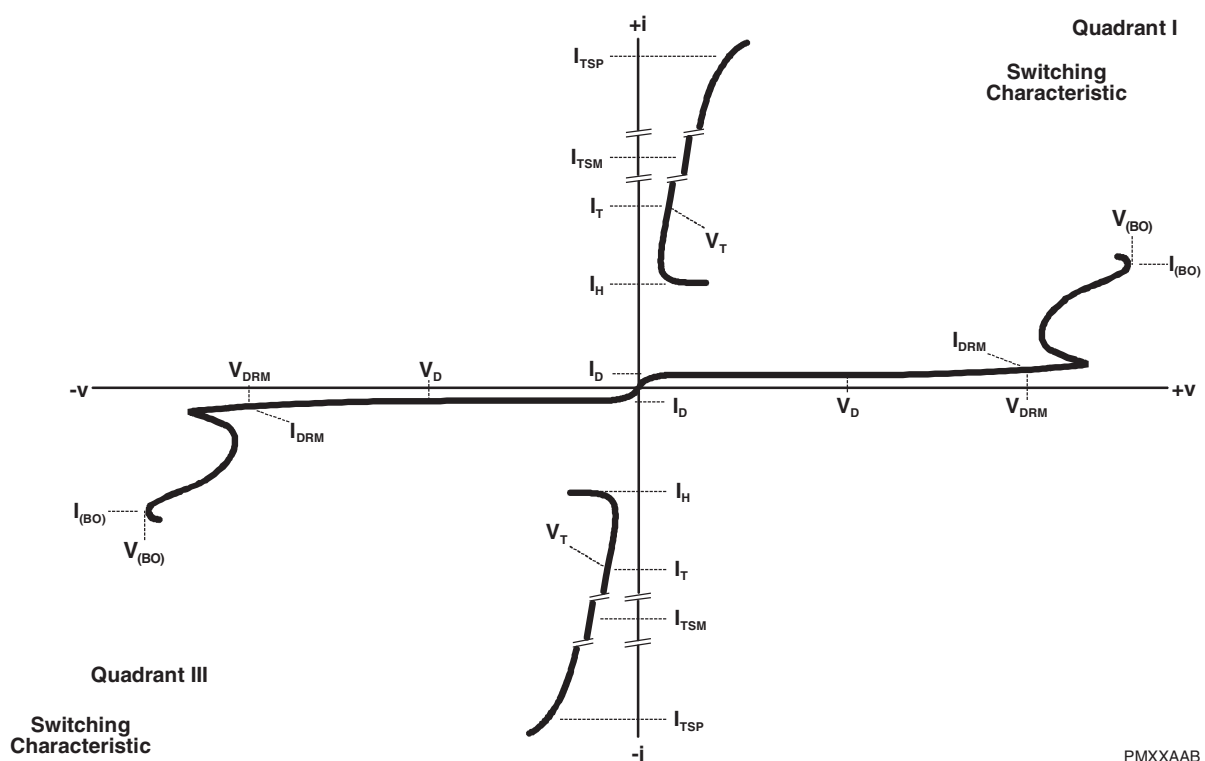

PMXXAAB

**Figure 1. Voltage-Current Characteristic for R and T Terminals**  
**All Measurements are Referenced to the T Terminal**

## Typical Characteristics

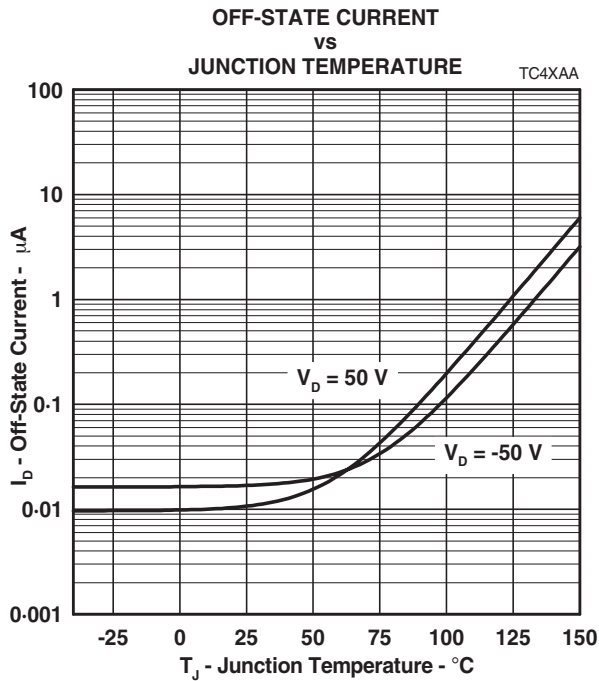

Figure 2.

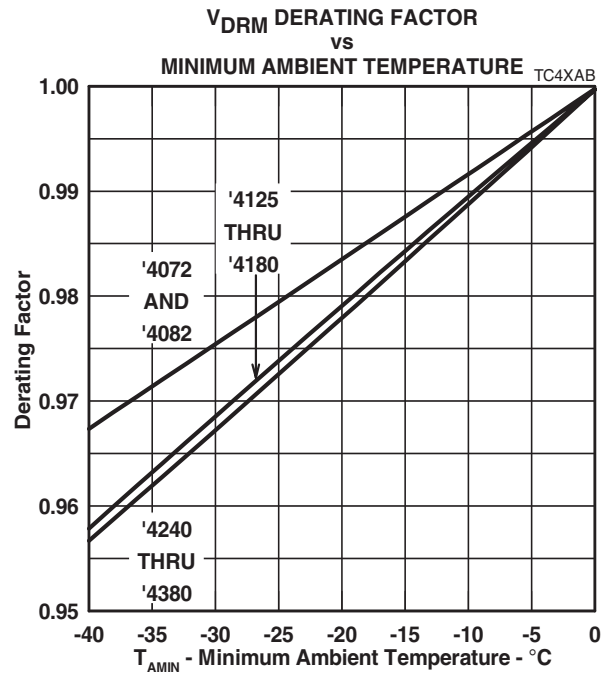

Figure 3.

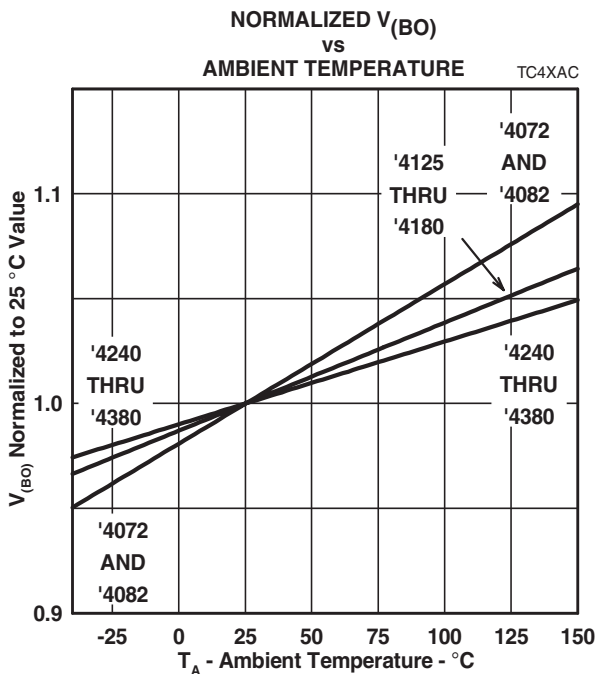

Figure 4.

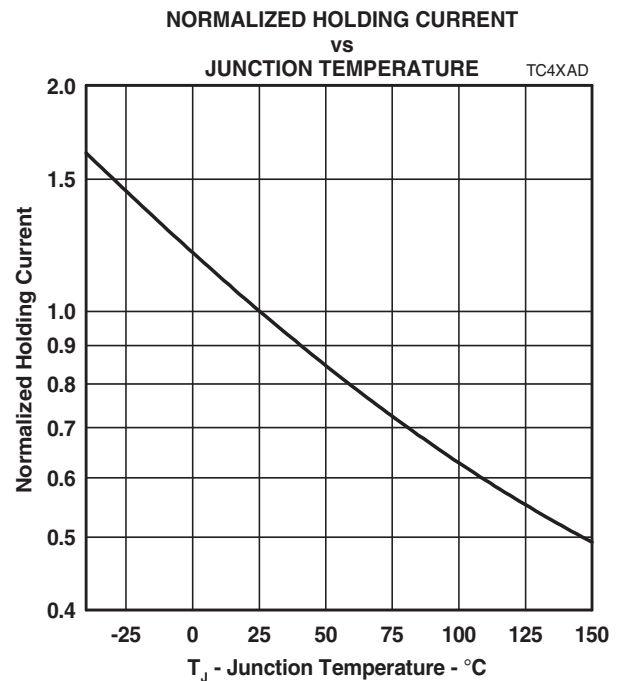
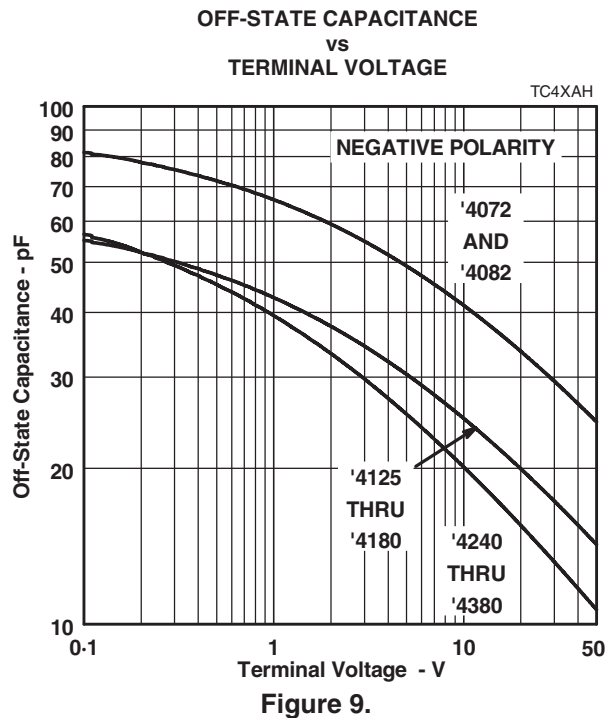
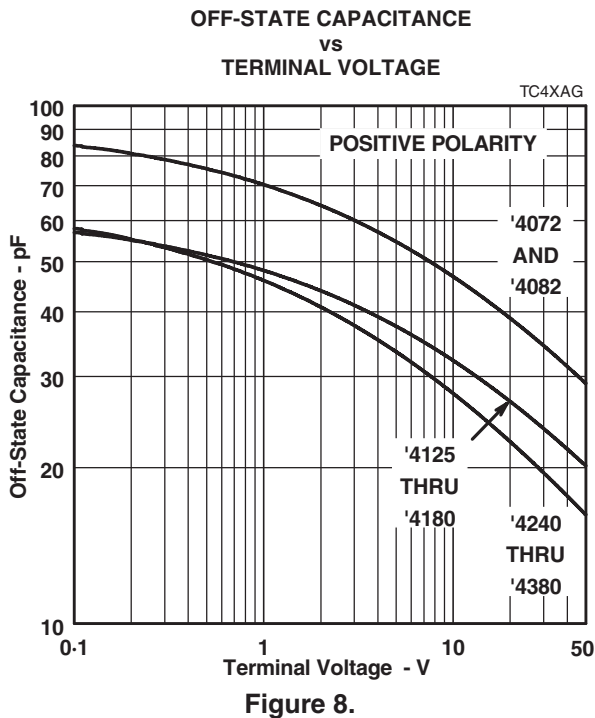
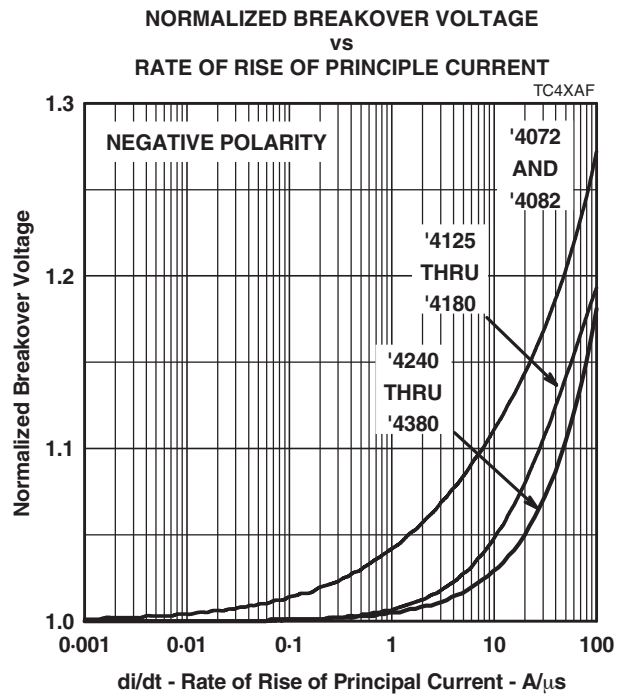
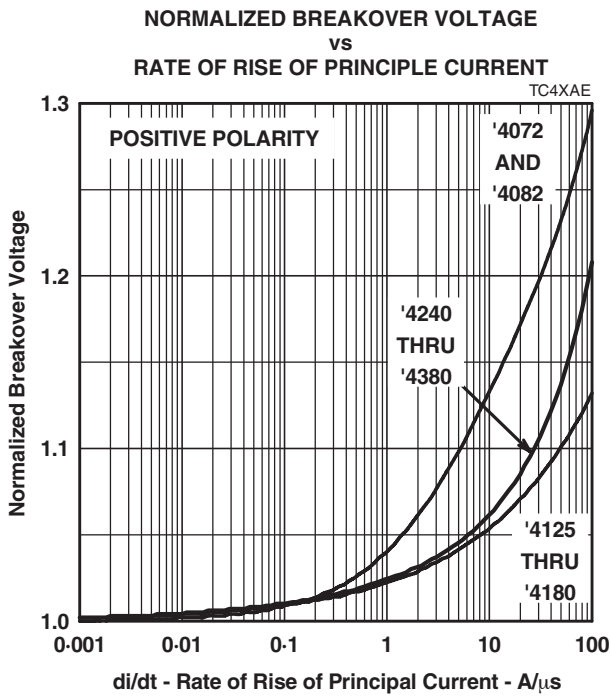
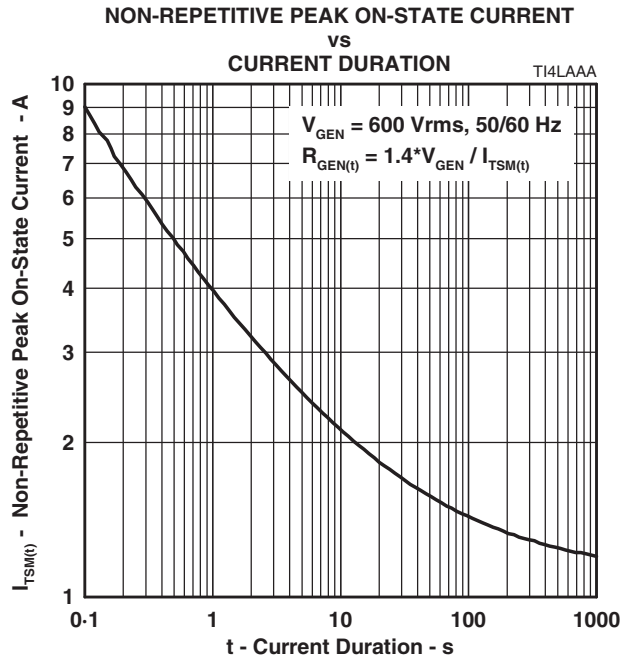

Figure 5.

## Typical Characteristics



## Typical Characteristics



**Figure 10.**

# TISP4xxxF3LM Overvoltage Protector Series

**BOURNS®**

## MECHANICAL DATA

### Device Symbolization Code

Devices will be coded as below.

Device	Symbolization Code
TISP4072F3	4072F3
TISP4082F3	4082F3
TISP4125F3	4125F3
TISP4150F3	4150F3
TISP4180F3	4180F3
TISP4240F3	4240F3
TISP4260F3	4260F3
TISP4290F3	4290F3
TISP4320F3	4320F3
TISP4380F3	4380F3

### Carrier Information

Devices are shipped in one of the carriers below. A reel contains 2,000 devices.

Package Type	Carrier	For Standard Termination Finish Order As	For Lead Free Termination Finish Order As
Straight Lead DO-92	Bulk Pack	TISP4xxxF3LM	TISP4xxxF3LM-S
Straight Lead DO-92	Tape and Reeled	TISP4xxxF3LMR	TISP4xxxF3LMR-S
Formed Lead DO-92	Tape and Reeled	TISP4xxxF3LMFR	TISP4xxxF3LMFRS



## MECHANICAL DATA

### LM002 (DO-92) 2-Pin Cylindrical Plastic Package

This single-in-line package consists of a circuit mounted on a lead frame and encapsulated within a plastic compound. The compound will withstand soldering temperature with no deformation, and circuit performance characteristics will remain stable when operated in high humidity conditions. Leads require no additional cleaning or processing when used in soldered assembly.

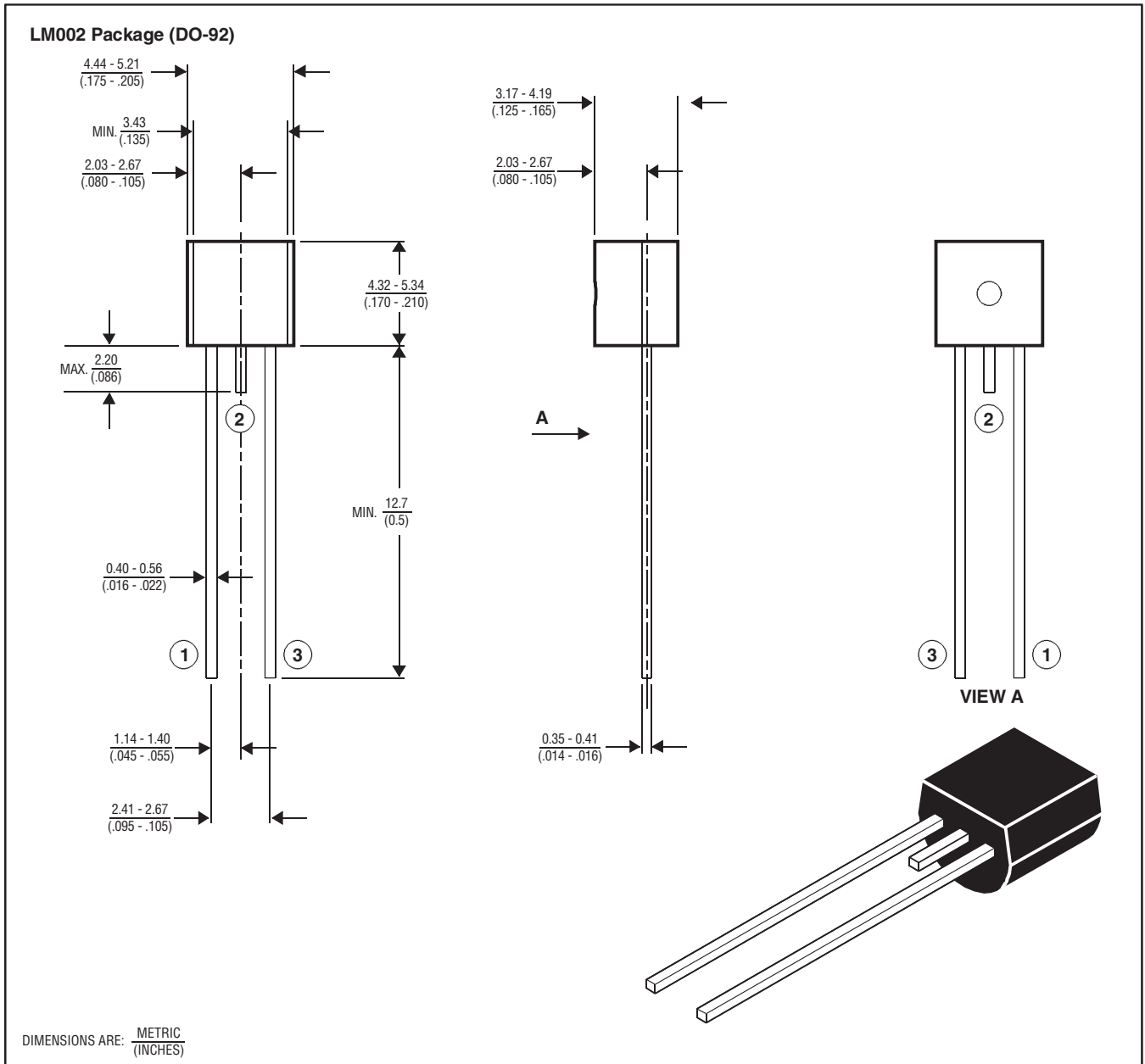

MD4XARA

# TISP4xxxF3LM Overvoltage Protector Series

**BOURNS®**

## MECHANICAL DATA

### LM002 (DO-92) - Formed Leads Version - 2-Pin Cylindrical Plastic Package

This single-in-line package consists of a circuit mounted on a lead frame and encapsulated within a plastic compound. The compound will withstand soldering temperature with no deformation, and circuit performance characteristics will remain stable when operated in high humidity conditions. Leads require no additional cleaning or processing when used in soldered assembly.

#### LMF002 (DO-92) - Formed Leads Version of LM002

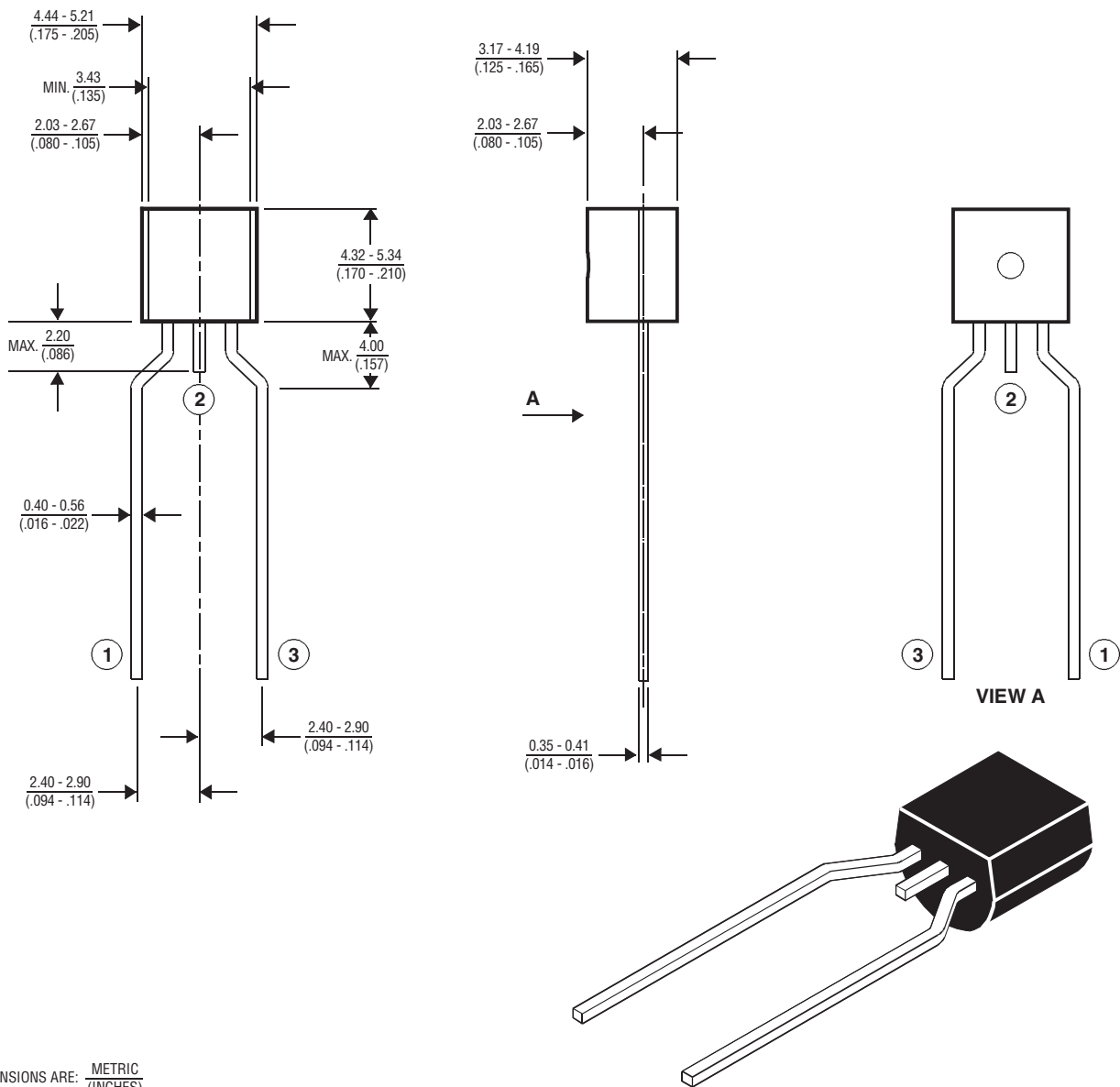

MD4XASA

NOVEMBER 1997 - REVISED FEBRUARY 2005

Specifications are subject to change without notice. Customers should verify actual device performance in their specific applications.

## MECHANICAL DATA

### Tape Dimensions

LMF002 Package (Formed Lead DO-92) Tape

LMF002 Tape Dimensions Conform to the Requirements of EIA-468-B

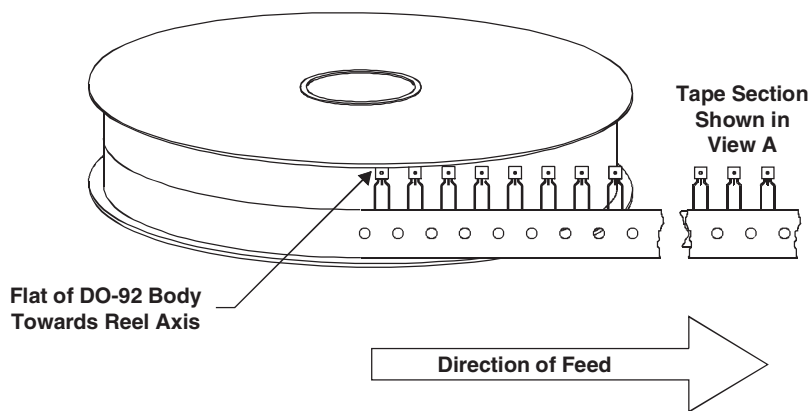
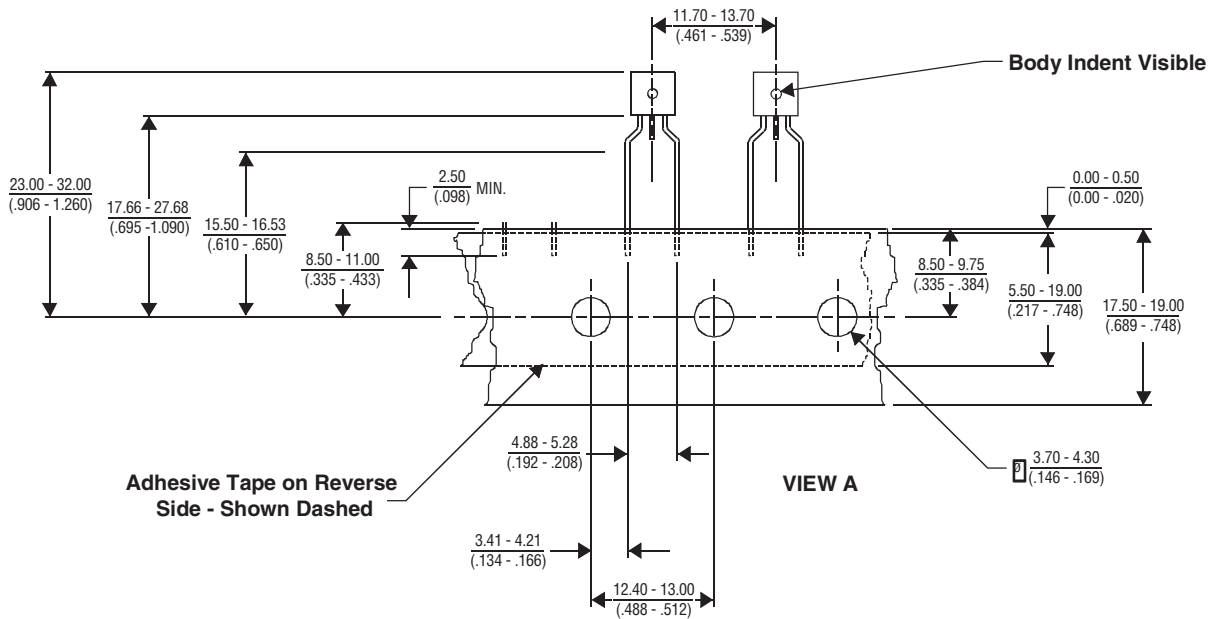

DIMENSIONS ARE:  $\frac{\text{METRIC}}{\text{(INCHES)}}$

MD4XAQC

"TISP" is a trademark of Bourns, Ltd., a Bourns Company, and is Registered in U.S. Patent and Trademark Office. "Bourns" is a registered trademark of Bourns, Inc. in the U.S. and other countries.

NOVEMBER 1997 - REVISED FEBRUARY 2005

Specifications are subject to change without notice.

Customers should verify actual device performance in their specific applications.