

DATA SHEET



SAA55xx

TV microcontrollers with Closed
Captioning (CC) and On-Screen
Display (OSD)

Preliminary specification
Supersedes data of 1999 Aug 02
File under Integrated Circuits, IC02

2000 Feb 23

TV microcontrollers with Closed Captioning (CC) and On-Screen Display (OSD)

SAA55xx

CONTENTS		
1	FEATURES	
2	GENERAL DESCRIPTION	
3	QUICK REFERENCE DATA	
4	ORDERING INFORMATION	
5	BLOCK DIAGRAM	
6	PINNING INFORMATION	
6.1	Pinning	
6.2	Pin description	
7	MICROCONTROLLER	
7.1	Microcontroller features	
8	MEMORY ORGANIZATION	
8.1	ROM bank switching	
8.2	RAM organisation	
8.3	Data memory	
8.4	SFR memory	
8.5	Character set feature bits	
8.6	External (auxiliary) memory	
9	REDUCED POWER MODES	
9.1	Idle mode	
9.2	Power-down mode	
9.3	Standby mode	
10	I/O FACILITY	
10.1	I/O ports	
10.2	Port type	
10.3	Port alternative functions	
10.4	LED support	
11	INTERRUPT SYSTEM	
11.1	Interrupt enable structure	
11.2	Interrupt enable priority	
11.3	Interrupt vector address	
11.4	Level/edge interrupt	
12	TIMER/COUNTER	
13	WATCHDOG TIMER	
13.1	Watchdog Timer operation	
14	PULSE WIDTH MODULATORS	
14.1	PWM control	
14.2	Tuning Pulse Width Modulator (TPWM)	
14.3	TPWM control	
14.4	Software ADC (SAD)	
15	I ² C-BUS SERIAL I/O	
		15.1 I ² C-bus port selection
		16 MEMORY INTERFACE
		16.1 Memory structure
		16.2 Memory mapping
		16.3 Addressing memory
		16.4 Page clearing
		17 DATA CAPTURE
		17.1 Data Capture features
		18 DISPLAY
		18.1 Display features
		18.2 Display modes
		18.3 Display feature descriptions
		18.4 Character and attribute coding
		18.5 Screen and global controls
		18.6 Text display controls
		18.7 Display positioning
		18.8 Character set
		18.9 ROM addressing
		18.10 Redefinable characters
		18.11 Display synchronization
		18.12 Video/Data switch (Fast Blanking) polarity
		18.13 Video/data switch adjustment
		18.14 RGB brightness control
		18.15 Contrast reduction
		19 MEMORY MAPPED REGISTERS (MMR)
		20 LIMITING VALUES
		21 CHARACTERISTICS
		22 QUALITY AND RELIABILITY
		23 APPLICATION INFORMATION
		24 ELECTROMAGNETIC COMPATIBILITY (EMC) GUIDELINES
		25 PACKAGE OUTLINES
		26 SOLDERING
		26.1 Introduction to soldering through-hole mount packages
		26.2 Soldering by dipping or by solder wave
		26.3 Manual soldering
		26.4 Suitability of through-hole mount IC packages for dipping and wave soldering methods
		27 DEFINITIONS
		28 LIFE SUPPORT APPLICATIONS
		29 PURCHASE OF PHILIPS I ² C COMPONENTS

TV microcontrollers with Closed Captioning (CC) and On-Screen Display (OSD)

SAA55xx

1 FEATURES

- Single-chip microcontroller with integrated On-Screen Display (OSD)
- One Time Programmable (OTP) memory for both Program ROM and character sets
- Single power supply: 3.0 to 3.6 V
- 5 V tolerant digital inputs and I/O
- 29 I/O port via individual addressable controls
- Programmable I/O for push-pull, open-drain and quasi-bidirectional
- Two port lines with 8 mA sink (at <math><0.4\text{ V}</math>) capability, for direct drive of Light Emitting Diode (LED)
- Single crystal oscillator for microcontroller, OSD and data capture
- Power reduction modes: Standby, Idle and Power-down
- Byte level I²C-bus up to 200 kHz with dual port I/O (Slave mode up to 400 kHz)
- 32 Dynamically Redefinable Characters for OSDs
- Special graphic characters allowing four colours per character
- Selectable character height 9, 10, 13 and 16 TV lines
- Pin compatibility throughout family
- Operating temperature: -20 to +70°C.



2 GENERAL DESCRIPTION

The SAA55xx OSD only family of devices are a derivative of the Philips industry standard 80C51 microcontroller and are intended for use as the central control mechanism in a television receiver. They provide control functions for the television system, On-Screen Display (OSD) and some versions include an integrated data capture function.

The main differences between the OSD only family and the SAA55xx Text/CC family of baseline devices are:

- Program ROM size: 16 to 64-kbyte
- Display RAM size: 1.25-kbyte (1 page Text OSD or CC/OSD)
- Auxiliary RAM size: 0.75-kbyte
- No teletext data capture (Closed Caption only)
- Additional power saving mode (Standby).

TV microcontrollers with Closed Captioning (CC) and On-Screen Display (OSD)

SAA55xx

3 QUICK REFERENCE DATA

SYMBOL	PARAMETER	MIN.	TYP.	MAX.	UNIT
Supply					
V_{DDX}	any supply voltage (V_{DD} to V_{SS})	3.0	3.3	3.6	V
I_{DDP}	periphery supply current; note 1	1	–	–	mA
I_{DDC}	core supply current	–	12	18	mA
$I_{DDC(id)}$	Idle mode core supply current	–	383	600	μ A
$I_{DDC(pd)}$	Power-down mode core supply current	–	666	900	μ A
$I_{DDC(stb)}$	Standby mode core supply current	–	5.1	9	mA
I_{DDA}	analog supply current	–	45	48	mA
$I_{DDA(id)}$	Idle mode analog supply current	–	444	700	μ A
$I_{DDA(pd)}$	Power-down mode analog supply current	–	433	700	μ A
$I_{DDA(stb)}$	Standby mode analog supply current	–	809	950	μ A
f_{xtal}	Fundamental mode nominal frequency	–	12	–	MHz
T_{amb}	operating ambient temperature	–20	–	+70	$^{\circ}$ C
T_{stg}	storage temperature	–55	–	+125	$^{\circ}$ C

Note

- Peripheral supply current is dependent on external components and voltage levels on I/Os.

4 ORDERING INFORMATION

TYPE NUMBER ⁽¹⁾	PACKAGE ⁽²⁾			ROM	RAM	CC
	NAME	DESCRIPTION	VERSION			
SAA5540PS/nnnn	SDIP52	plastic shrink dual in-line package; 52 leads (600 mil)	SOT247-1	16-kbyte	256-byte	yes
SAA5541PS/nnnn				32-kbyte	512-byte	yes
SAA5542PS/nnnn				48-kbyte	750-byte	yes
SAA5543PS/nnnn				64-kbyte	750-byte	yes
SAA5547PS/nnnn				24-kbyte	750-byte	yes

Notes

- 'nnnn' is a four digit number uniquely referencing the microcontroller program mask.
- For details of the LQFP100 package, please contact your local regional sales office for availability.

TV microcontrollers with Closed Captioning (CC) and On-Screen Display (OSD)

SAA55xx

5 BLOCK DIAGRAM

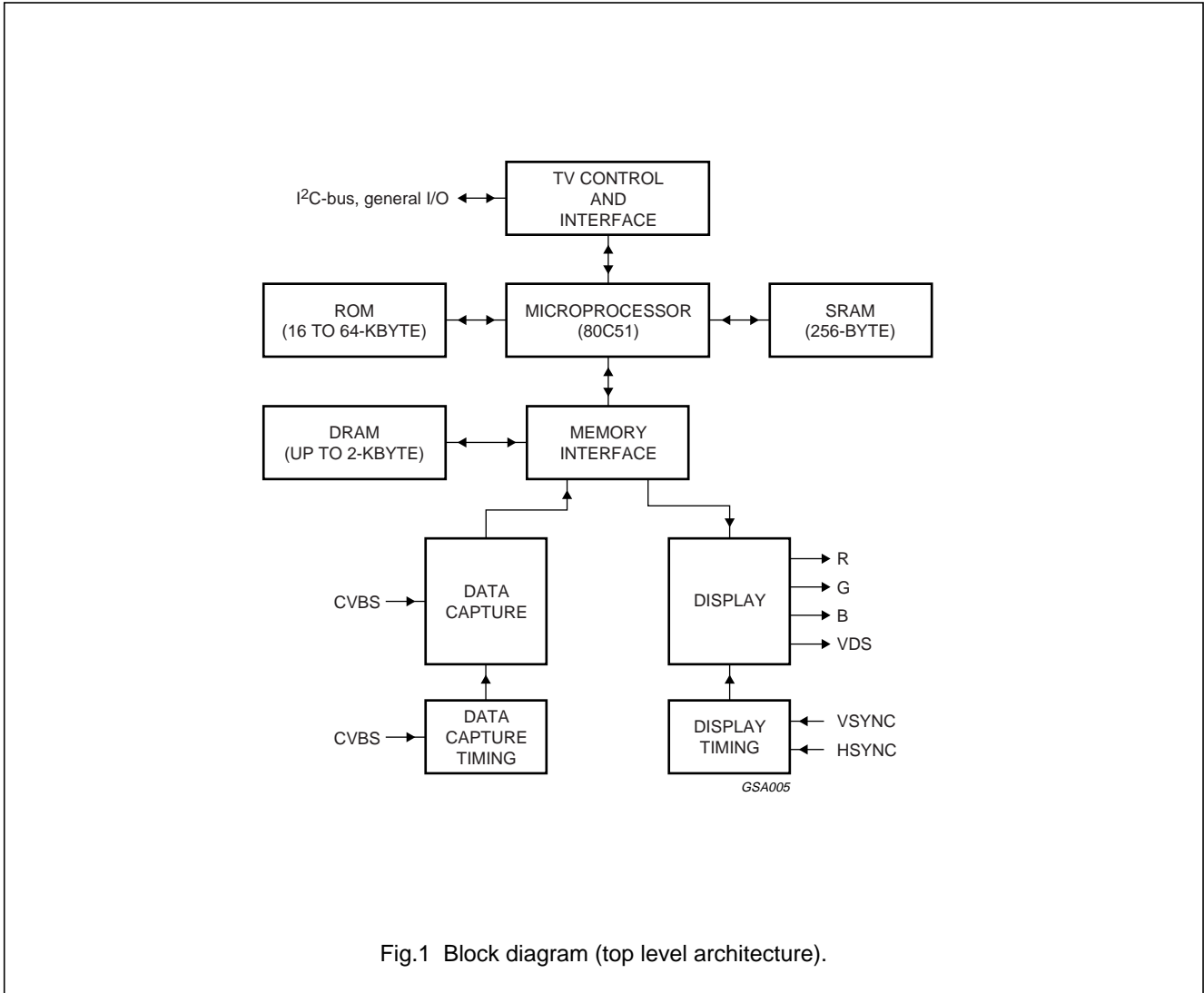

Fig.1 Block diagram (top level architecture).

TV microcontrollers with Closed Captioning (CC) and On-Screen Display (OSD)

SAA55xx

6 PINNING INFORMATION

6.1 Pinning

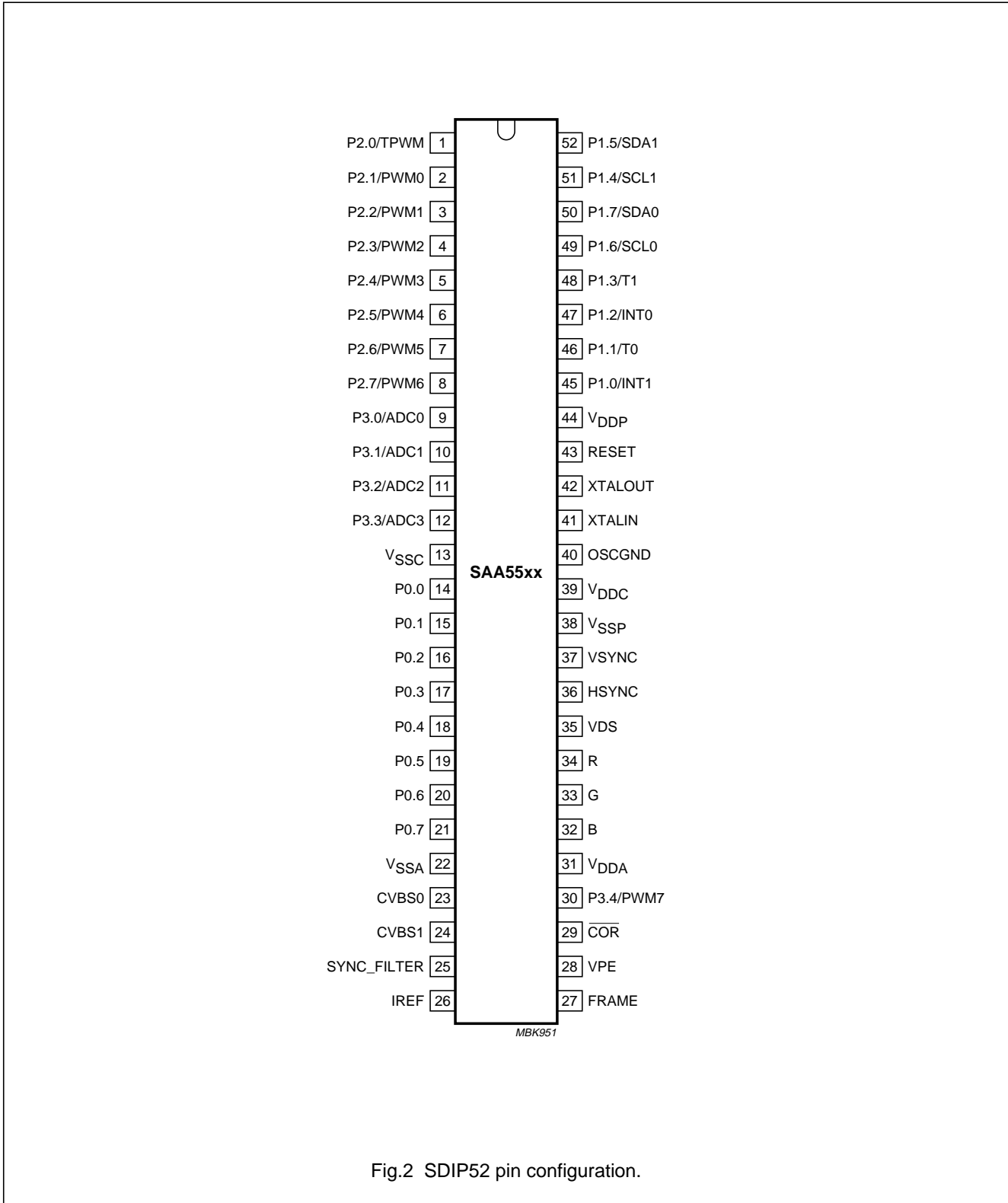

Fig.2 SDIP52 pin configuration.

TV microcontrollers with Closed Captioning (CC) and On-Screen Display (OSD)

SAA55xx

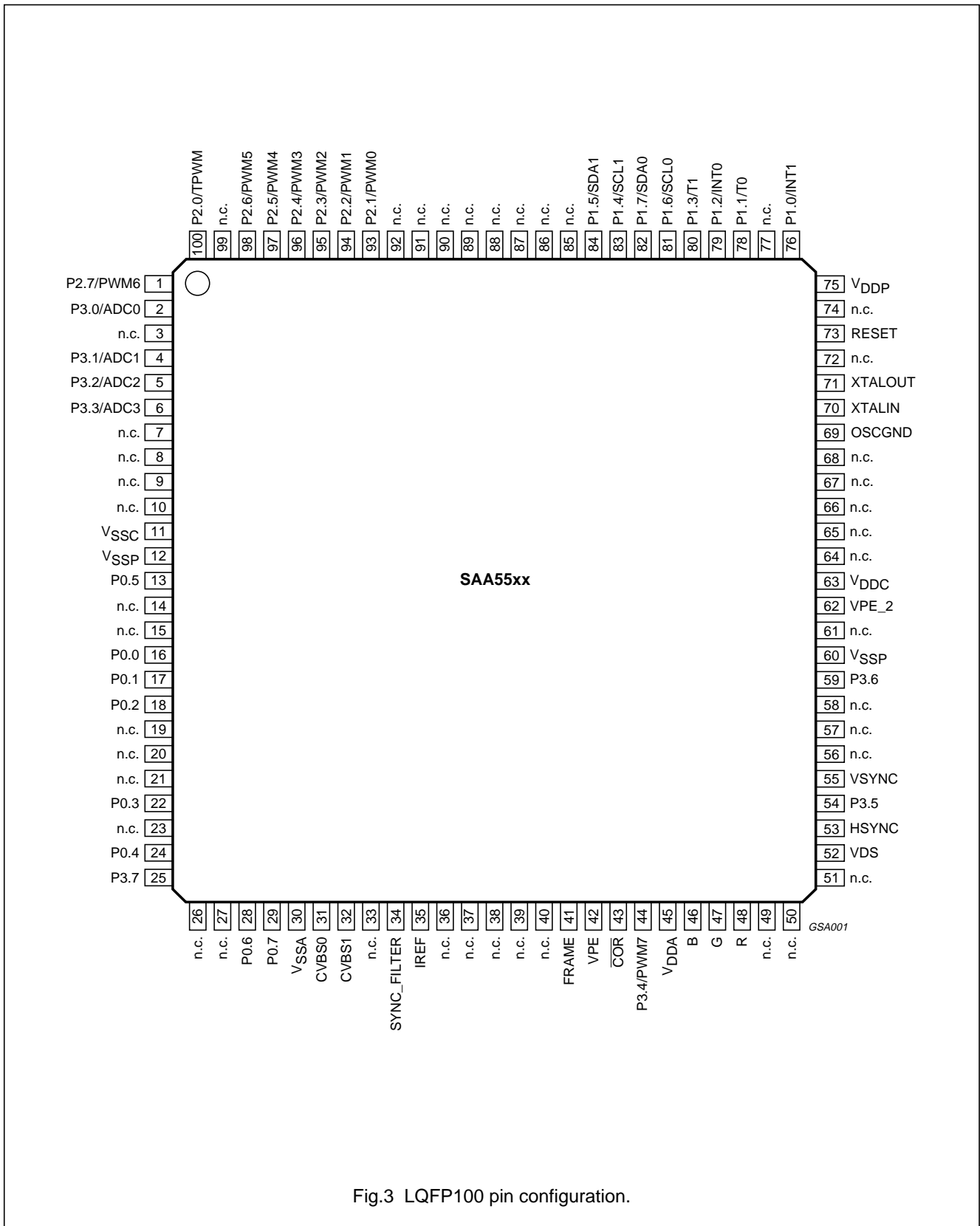

Fig.3 LQFP100 pin configuration.

TV microcontrollers with Closed Captioning (CC) and On-Screen Display (OSD)

SAA55xx

6.2 Pin description

Table 1 SDIP52 and LQFP100 packages

SYMBOL	PIN		TYPE	DESCRIPTION
	SDIP52	LQFP100		
P2.0/TPWM	1	100	I/O	Port 2. 8-bit programmable bidirectional port with alternative functions. P2.0/TPWM is the output for the 14-bit high precision PWM. P2.1/PWM0 to P2.7/PWM6 are the outputs for the 6-bit PWMs 0 to 6.
P2.1/PWM0	2	93	I/O	
P2.2/PWM1	3	94	I/O	
P2.3/PWM2	4	95	I/O	
P2.4/PWM3	5	96	I/O	
P2.5/PWM4	6	97	I/O	
P2.6/PWM5	7	98	I/O	
P2.7/PWM6	8	1	I/O	
P3.0/ADC0	9	2	I/O	Port 3. 8-bit programmable bidirectional port with alternative functions. P3.0/ADC0 to P3.3/ADC3 are the inputs for the software ADC facility. P3.4/PWM7 is the output for the 6-bit PWM7. P3.5 to P3.7 have no alternative functions and are only available with the LQFP100 package.
P3.1/ADC1	10	4	I/O	
P3.2/ADC2	11	5	I/O	
P3.3/ADC3	12	6	I/O	
P3.4/PWM7	30	44	I/O	
P3.5	–	54	I/O	
P3.6	–	59	I/O	
P3.7	–	25	I/O	
V _{SSC}	13	11	–	core ground
P0.0	14	16	I/O	Port 0. 8-bit programmable bidirectional port. P0.5 and P0.6 have 8 mA current sinking capability for direct drive of LEDs.
P0.1	15	17	I/O	
P0.2	16	18	I/O	
P0.3	17	22	I/O	
P0.4	18	24	I/O	
P0.5	19	13	I/O	
P0.6	20	28	I/O	
P0.7	21	29	I/O	
V _{SSA}	22	30	–	analog ground
CVBS0	23	31	I	Composite Video Baseband Signal (CVBS) input. A positive-going 1 V (peak-to-peak) input is required.
CVBS1	24	32	I	Connected via a 100 nF capacitor.
SYNC_FILTER	25	34	I	CVBS sync filter input. This pin should be connected to V _{SSA} via a 100 nF capacitor.
IREF	26	35	I	Reference current input for analog circuits, connected to V _{SSA} via a 24 K Ω resistor.
FRAME	27	41	O	De-interlace output synchronised with the VSYNC pulse to produce a non-interlaced display by adjustment of the vertical deflection circuits.
VPE	28	42	I	OTP programming voltage

TV microcontrollers with Closed Captioning (CC)
and On-Screen Display (OSD)

SAA55xx

SYMBOL	PIN		TYPE	DESCRIPTION
	SDIP52	LQFP100		
COR	29	43	O	Open-drain, active LOW output which allows selective contrast reduction of the TV picture to enhance a mixed mode display.
V _{DDA}	31	45	–	+3.3 V analog power supply
B	32	46	O	Pixel rate output of the BLUE colour information.
G	33	47	O	Pixel rate output of the GREEN colour information.
R	34	48	O	Pixel rate output of the RED colour information.
VDS	35	52	O	Video/data switch push-pull output for dot rate fast blanking.
HSYNC	36	53	I	Schmitt triggered input TTL version of the horizontal sync pulse. The polarity of this pulse is programmable by register bit TXT1.H POLARITY.
VSYSN	37	55	I	Schmitt triggered input for a TTL version of the vertical sync pulse. The polarity of this pulse is programmable by register bit TXT1.V POLARITY.
V _{SSP}	38	12, 60	–	periphery ground
V _{DDC}	39	63	–	+3.3 V core power supply
OSCGND	40	69	–	crystal oscillator ground
XTALIN	41	70	I	12 MHz crystal oscillator input
XTALOUT	42	71	O	12 MHz crystal oscillator output
RESET	43	73	I	If the reset input is HIGH for at least 2 machine cycles (24 oscillator periods) while the oscillator is running, the device is reset. This pin should be connected to V _{DDP} via a capacitor.
V _{DDP}	44	75	–	+3.3 V periphery power supply
P1.0/INT1	45	76	I/O	Port 1. 8-bit programmable bidirectional port with alternative functions. P1.0/INT1 is external interrupt 1 which can be triggered on the rising and falling edge of the pulse. P1.1/T0 is the Counter/Timer 0. P1.2/INT0 is external interrupt 0. P1.3/T1 is the Counter/Timer 1. P1.6/SCL0 is the serial clock input for the I ² C-bus and P1.7/SDA0 is the serial data port for the I ² C-bus. P1.4/SCL1 is the serial clock input for the I ² C-bus and P1.5/SDA1 is the serial data port for the I ² C-bus.
P1.1/T0	46	78	I/O	
P1.2/INT0	47	79	I/O	
P1.3/T1	48	80	I/O	
P1.6/SCL0	49	81	I/O	
P1.7/SDA0	50	82	I/O	
P1.4/SCL1	51	83	I/O	
P1.5/SDA1	52	84	I/O	
VPE_2	–	62	I	OTP programming voltage
n.c.	–	3, 7 to 10, 14, 15, 19 to 21, 23, 26, 27, 33, 36 to 40, 49 to 51, 56 to 58, 61, 64 to 68, 72, 74, 77, 85 to 92, 99	–	not connected

TV microcontrollers with Closed Captioning (CC) and On-Screen Display (OSD)

SAA55xx

7 MICROCONTROLLER

The functionality of the microcontroller used on this device is described here with reference to the industry standard 80C51 microcontroller. A full description of its functionality can be found in the *“Handbook IC20, 80C51-Based 8-bit Microcontrollers”*.

7.1 Microcontroller features

- 80C51 microcontroller core standard instruction set and timing
- 1 μ s machine cycle
- Maximum 64K \times 8-bit program ROM
- 2 \times 8-bit auxiliary RAM, maximum of 1.25 kbytes required for display
- Interrupt controller for individual enable/disable with two level priority
- Two 16-bit timer/counter registers
- Watchdog Timer
- Auxiliary RAM page pointer
- 16-bit data pointer
- Standby, Idle and Power-down modes
- 29 general I/O lines
- Eight 6-bit Pulse Width Modulator (PWM) outputs for control of TV analog signals
- One 14-bit PWM for Voltage Synthesis Tuner (VST) control
- 8-bit Analog-to-Digital Converter (ADC) with four multiplexed inputs
- 2 high current outputs for directly driving LEDs
- I²C-bus byte level bus interface with dual ports.

8 MEMORY ORGANIZATION

The device has the capability of a maximum of 64-kbyte Program ROM and 2-kbyte Data RAM internally.

8.1 ROM bank switching

As the Program ROM does not exceed 64 kbytes in any of the OSD only variants, ROM bank switching is not required.

The memory and security bits are structured as shown in Fig.4.

The OSD only security bits are set as shown in Fig.5 for production programmed devices.

The OSD only security bits are set as shown in Fig.6 for production blank devices.

8.2 RAM organisation

The Internal Data RAM is organized into two areas, Data memory and Special Function Registers (SFRs).

8.3 Data memory

The Data memory is 256 \times 8-bit, and occupies the address range 00H to FFH when using indirect addressing and 00H to 7FH when using direct addressing. The SFRs occupy the address range 80H to FFH and are accessible using direct addressing only.

The lower 128 bytes of Data memory are mapped as shown in Fig.8.

The lowest 24 bytes are grouped into 4 banks of 8 registers, the next 16 bytes above the register banks form a block of bit addressable memory space.

The upper 128 bytes are not allocated for any special area or functions.

TV microcontrollers with Closed Captioning (CC) and On-Screen Display (OSD)

SAA55xx

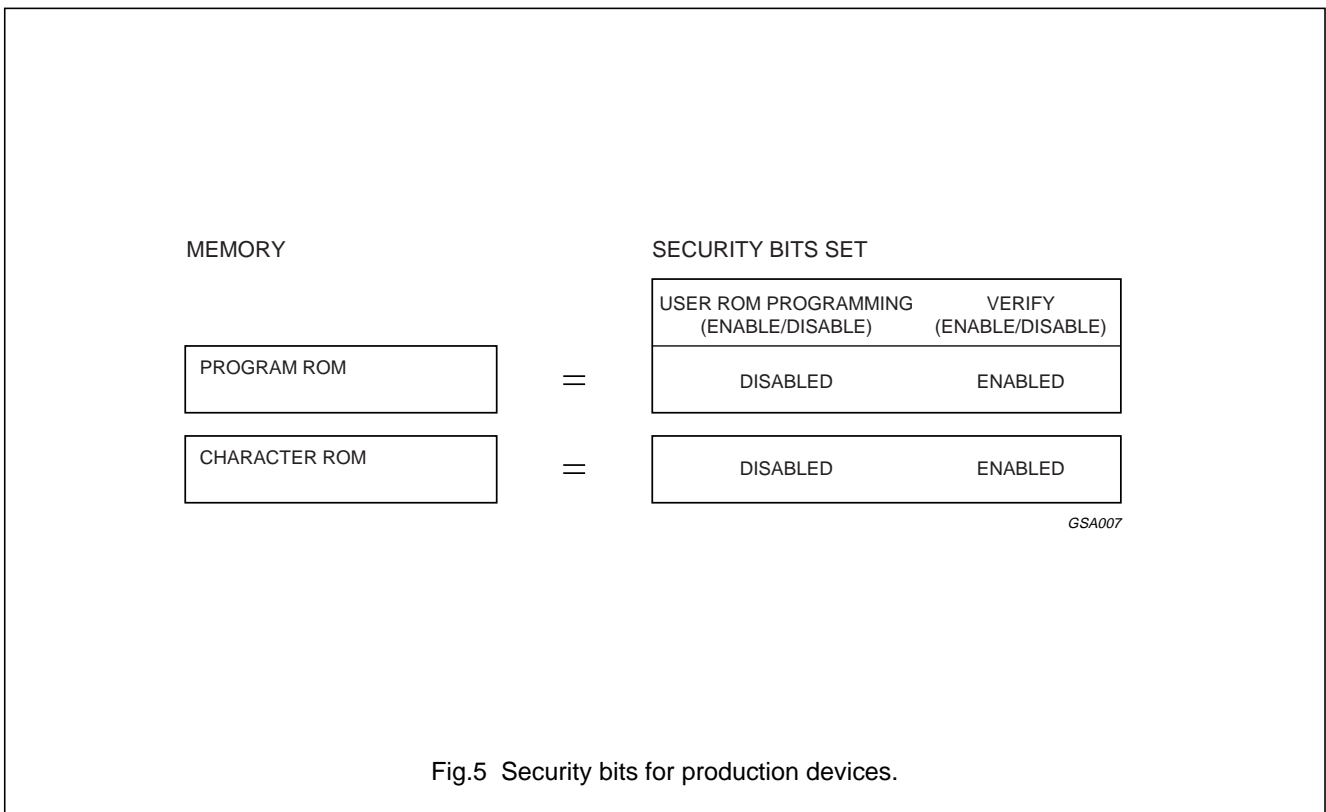
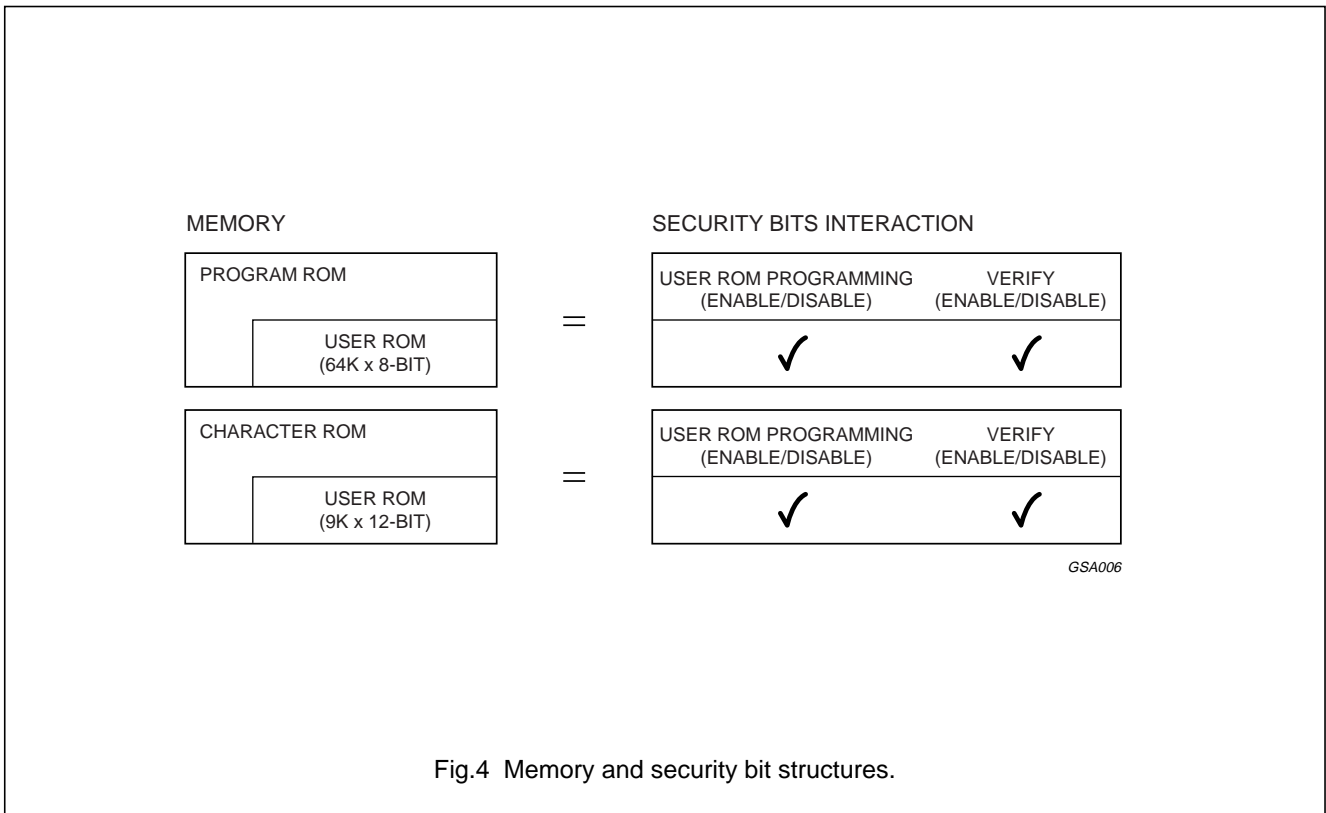

TV microcontrollers with Closed Captioning (CC) and On-Screen Display (OSD)

SAA55xx

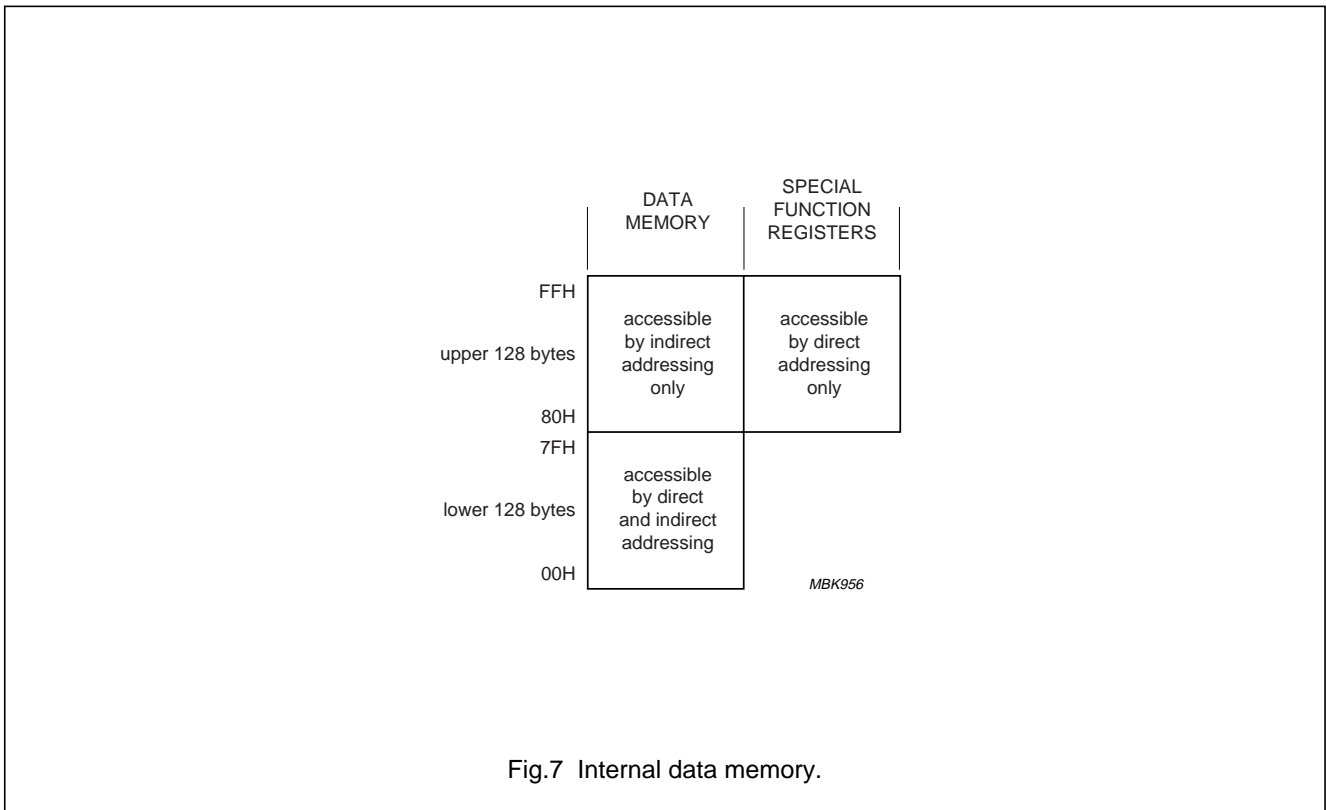
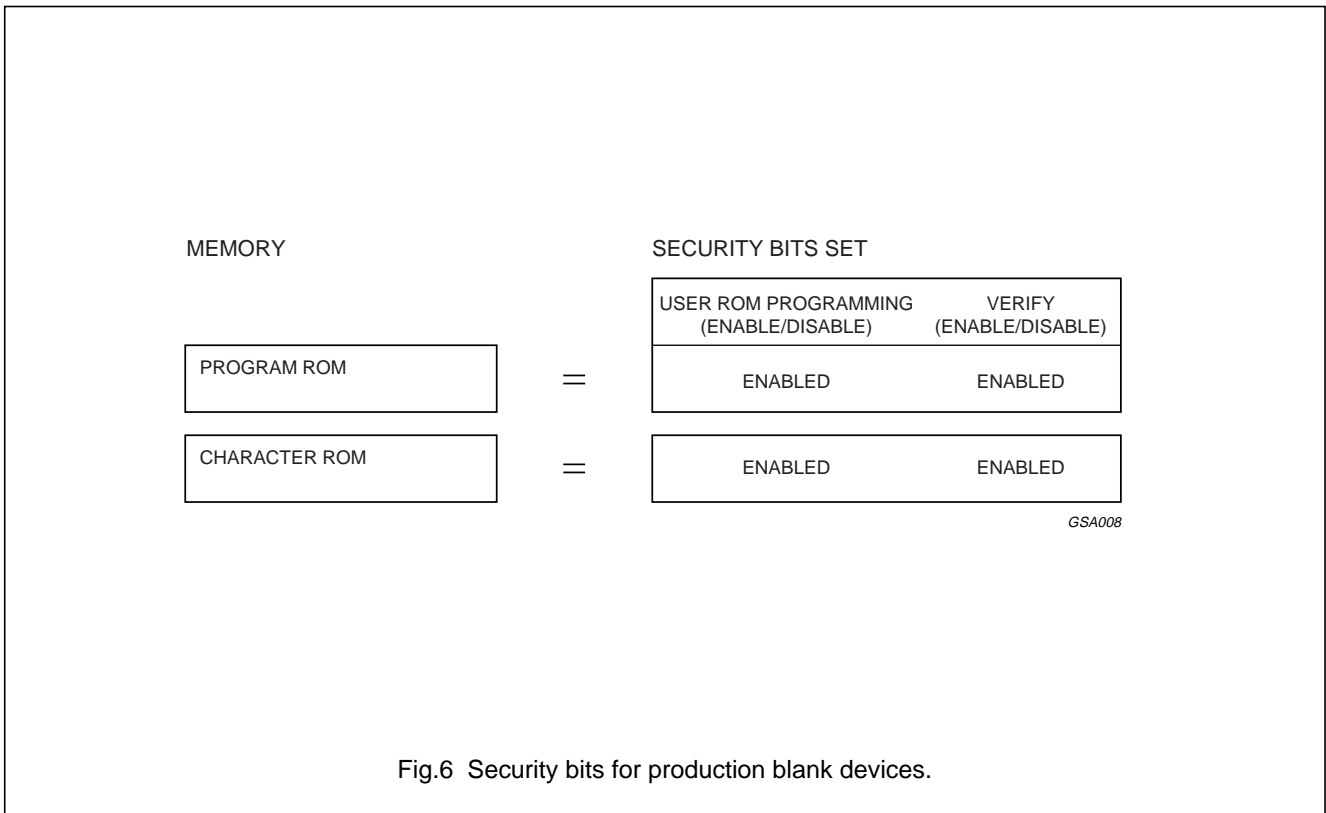

TV microcontrollers with Closed Captioning (CC)
and On-Screen Display (OSD)

SAA55xx

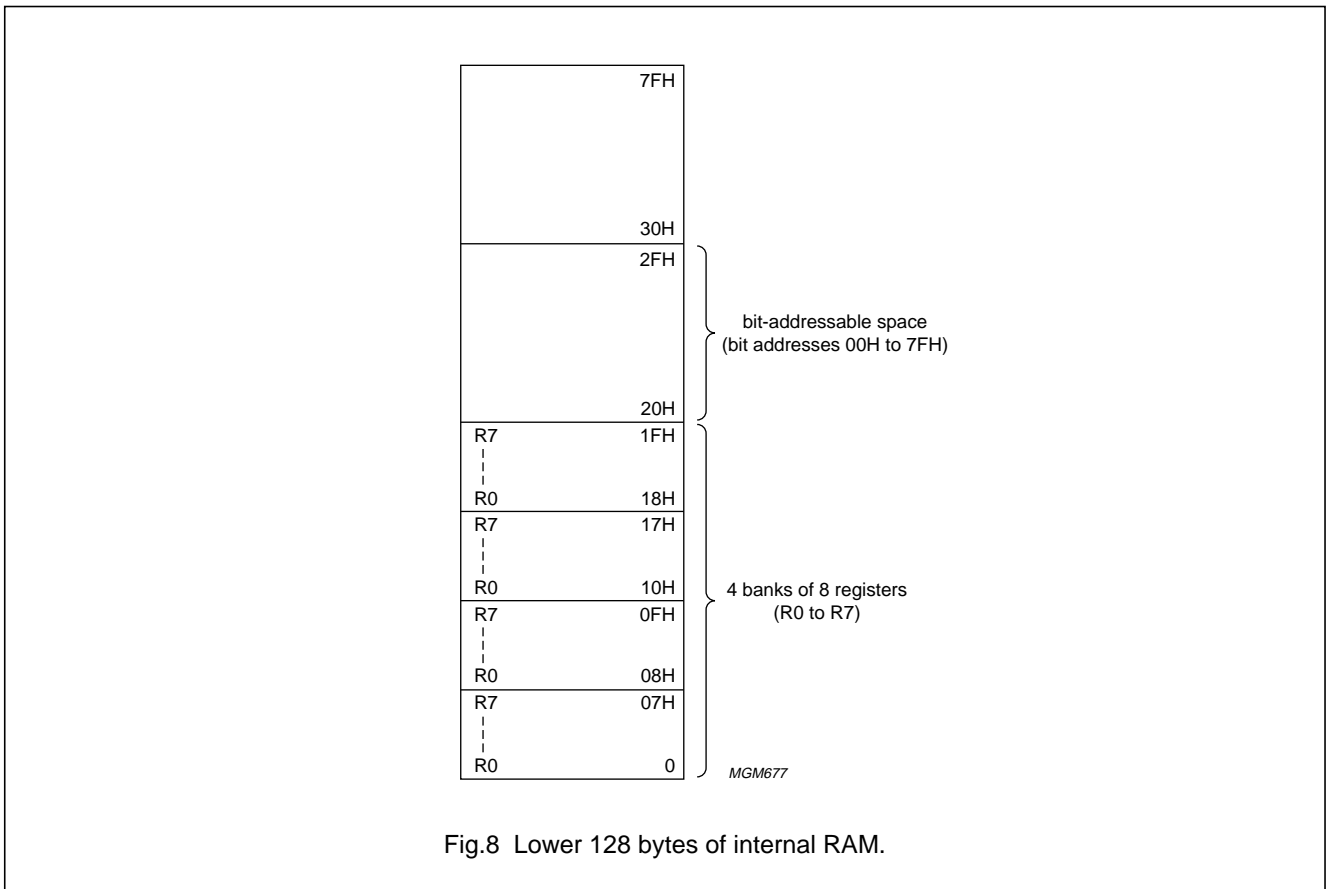

TV microcontrollers with Closed Captioning (CC) and On-Screen Display (OSD)

SAA55xx

8.4 SFR memory

The Special Function Register (SFR) space is used for port latches, timer, peripheral control, acquisition control, display control, etc. These registers can only be accessed by direct addressing. Sixteen of the addresses in the SFR space are both bit and byte addressable. The bit addressable SFRs are those whose address ends in 0H or 8H. A summary of the SFR map in address order is shown in Table 2.

A description of each of the SFR bits is shown in Table 3 which presents the SFRs in alphabetical order.

Table 2 SFR memory map

ADD	R/W	NAME	7	6	5	4	3	2	1	0	RESET
80H	R/W	PO	P07	P06	P05	P04	P03	P02	P01	P00	FFH
81H	R/W	SP	SP7	SP6	SP5	SP4	SP3	SP2	SP1	SP0	07H
82H	R/W	DPL	DPL7	DPL6	DPL5	DPL4	DPL3	DPL2	DPL1	DPL0	00H
83H	R/W	DPH	DPH7	DPH6	DPH5	DPH4	DPH3	DPH2	DPH1	DPH0	00H
87H	R/W	PCON	0	ARD	RFI	WLE	GF1	GF0	PD	IDL	00H
88H	R/W	TCON	TF1	TR1	TF0	TR0	IE1	IT1	IE0	IT0	00H
89H	R/W	TMOD	GATE	C/T	M1	M0	GATE	C/T	M1	M0	00H
8AH	R/W	TL0	TL07	TL06	TL05	TL04	TL03	TL02	TL01	TL00	00H
8BH	R/W	TL1	TL17	TL16	TL15	TL14	TL13	TL12	TL11	TL10	00H
8CH	R/W	TH0	TH07	TH06	TH05	TH04	TH03	TH02	TH01	TH00	00H
8DH	R/W	TH1	TH17	TH16	TH15	TH14	TH13	TH12	TH11	TH10	00H
90H	R/W	P1	P17	P16	P15	P14	P13	P12	P11	P10	FFH
96H	R/W	P0CFGA	P0CFGA7	P0CFGA6	P0CFGA5	P0CFGA4	P0CFGA3	P0CFGA2	P0CFGA1	P0CFGA0	FFH
97H	R/W	P0CFGB	P0CFGB7	P0CFGB6	P0CFGB5	P0CFGB4	P0CFGB3	P0CFGB2	P0CFGB1	P0CFGB0	00H
98H	R/W	SADB	0	0	0	DC_COMP	SAD3	SAD2	SAD1	SAD0	00H
9EH	R/W	P1CFGA	P1CFGA7	P1CFGA6	P1CFGA5	P1CFGA4	P1CFGA3	P1CFGA2	P1CFGA1	P1CFGA0	FFH
9FH	R/W	P1CFGB	P1CFGB7	P1CFGB6	P1CFGB5	P1CFGB4	P1CFGB3	P1CFGB2	P1CFGB1	P1CFGB0	00H
A0H	R/W	P2	P27	P26	P25	P24	P23	P22	P21	P20	FFH
A6H	R/W	P2CFGA	P2CFGA7	P2CFGA6	P2CFGA5	P2CFGA4	P2CFGA3	P2CFGA2	P2CFGA1	P2CFGA0	FFH
A7H	R/W	P2CFGB	P2CFGB7	P2CFGB6	P2CFGB5	P2CFGB4	P2CFGB3	P2CFGB2	P2CFGB1	P2CFGB0	00H
A8H	R/W	IE	EA	EBUSY	ES2	ECC	ET1	EX1	ET0	EX0	00H
B0H	R/W	P3	P37	P36	P35	P34	P33	P32	P31	P30	FFH
B2H	R/W	TX18	NOT3	NOT2	NOT1	NOT0	0	0	BS1	BS0	00H
B3H	R/W	TX19	TEN	TC2	TC1	TC0	0	0	TS1	TS0	00H
B4H	R/W	TX20	DRCS ENABLE	OSD PLANES	0	0	OSDLANG ENABLE	OSD LAN2	OSD LAN1	OSD LAN0	00H

TV microcontrollers with Closed Captioning (CC)
and On-Screen Display (OSD)

SAA55xx

ADD	R/W	NAME	7	6	5	4	3	2	1	0	RESET
B5H	R/W	TXT21	DISP LINES1	DISP LINES0	CHAR SIZE1	CHAR SIZE0	I ² C PORT 1	CC ON	I ² C PORT 0	CC/TXT	02H
B6H	R	TXT22	GPF7	GPF6	GPF5	GPF4	GPF3	GPF2	GPF1	GPF0	XXH
B7H	R/W	CCLIN	0	0	0	CS4	CS3	CS2	CS1	CS0	15H
B8H	R/W	IP	0	PBUSY	PES2	PCC	PT1	PX1	PT0	PX0	00H
B9H	R/W	TXT17	0	FORCE ACQ1	FORCE ACQ0	FORCE DISP1	FORCE DISP0	SCREEN COL2	SCREEN COL1	SCREEN COL0	00H
BEH	R/W	P3CFGA	P3CFGA7	P3CFGA6	P3CFGA5	P3CFGA4	P3CFGA3	P3CFGA2	P3CFGA1	P3CFGA0	FFH
BFH	R/W	P3CFGB	P3CFGB7	P3CFGB6	P3CFGB5	P3CFGB4	P3CFGB3	P3CFGB2	P3CFGB1	P3CFGB0	00H
C0H	R/W	TXT0	(reserved) 0	(reserved) 0	AUTO FRAME	(reserved) 0	(reserved) 0	DISABLE FRAME	(reserved) 0	(reserved) 0	00H
C1H	R/W	TXT1	(reserved) 0	(reserved) 0	(reserved) 0	(reserved) 0	(reserved) 0	FIELD POLARITY	H POLARITY	V POLARITY	00H
C4H	R/W	TXT4	OSD BANK ENABLE	QUAD WIDTH ENABLE	EAST/WEST	DISABLE DOUBLE HEIGHT	B MESH ENABLE	C MESH ENABLE	TRANS ENABLE	SHADOW ENABLE	00H
C5H	R/W	TXT5	BKGND OUT	BKGND IN	COR OUT	COR IN	TEXT OUT	TEXT IN	PICTURE ON OUT	PICTURE ON IN	03H
C6H	R/W	TXT6	BKGND OUT	BKGND IN	COR OUT	COR IN	TEXT OUT	TEXT IN	PICTURE ON OUT	PICTURE ON IN	03H
C7H	R/W	TXT7	(reserved) 0	CURSOR ON	(reserved) 0	(reserved) 0	DOUBLE HEIGHT	BOX ON 24	BOX ON 1 - 23	BOX ON 0	00H
C8H	R/W	TXT8	(reserved) 0	FLICKER STOP ON	(reserved) 0	DISABLE SPANISH	PKT 26 RECEIVED	WSS RECEIVED	WSS ON	CVBS1/ CVBS0	00H
C9H	R/W	TXT9	CURSOR FREEZE	CLEAR MEMORY	(reserved) 0	R4	R3	R2	R1	R0	00H
CAH	R/W	TXT10	0	0	C5	C4	C3	C2	C1	C0	00H
CBH	R/W	TXT11	D7	D6	D5	D4	D3	D2	D1	D0	00H
CCH	R	TXT12	525/625 SYNC	ROM VER4	ROM VER3	ROM VER2	ROM VER1	ROM VER0	1	VIDEO SIGNAL QUALITY	XXXX XX1X
D0H	R/W	PSW	C	AC	F0	RS1	RS0	OV	-	P	00H
D2H	R/W	TDACL	TD7	TD6	TD5	TD4	TD3	TD2	TD1	TD0	00H
D3H	R/W	TDACH	TPWE	1	TD13	TD12	TD11	TD10	TD9	TD8	40H

TV microcontrollers with Closed Captioning (CC) and On-Screen Display (OSD)

SAA55xx

ADD	R/W	NAME	7	6	5	4	3	2	1	0	RESET
D4H	R/W	PWM7	PW7E	1	PW7V5	PW7V4	PW7V3	PW7V2	PW7V1	PW7V0	40H
D5H	R/W	PWM0	PW0E	1	PW0V5	PW0V4	PW0V3	PW0V2	PW0V1	PW0V0	40H
D6H	R/W	PWM1	PW1E	1	PW1V5	PW1V4	PW1V3	PW1V2	PW1V1	PW1V0	40H
D7H	R	CCDAT1	CCD17	CCD16	CCD15	CCD14	CCD13	CCD12	CCD11	CCD10	00H
D8H	R/W	S1CON	CR2	ENSI	STA	STO	SI	AA	CR1	CR0	00H
D9H	R	S1STA	STAT4	STAT3	STAT2	STAT1	STAT0	0	0	0	F8H
DAH	R/W	S1DAT	DAT7	DAT6	DAT5	DAT4	DAT3	DAT2	DAT1	DAT0	00H
DBH	R/W	S1ADR	ADR6	ADR5	ADR4	ADR3	ADR2	ADR1	ADR0	GC	00H
DCH	R/W	PWM3	PW3E	1	PW3V5	PW3V4	PW3V3	PW3V2	PW3V1	PW3V0	40H
DDH	R/W	PWM4	PW4E	1	PW4V5	PW4V4	PW4V3	PW4V2	PW4V1	PW4V0	40H
DEH	R/W	PWM5	PW5E	1	PW5V5	PW5V4	PW5V3	PW5V2	PW5V1	PW5V0	40H
DFH	R/W	PWM6	PW6E	1	PW6V5	PW6V4	PW6V3	PW6V2	PW6V1	PW6V0	40H
E0H	R/W	ACC	ACC7	ACC6	ACC5	ACC4	ACC3	ACC2	ACC1	ACC0	00H
E4H	R/W	PWM2	PW2E	1	PW2V5	PW2V4	PW2V3	PW2V2	PW2V1	PW2V0	40H
E7H	R	CCDAT2	CCD27	CCD26	CCD25	CCD24	CCD23	CCD22	CCD21	CCD20	00H
E8H	R/W	SAD	VHI	CH1	CH0	ST	SAD7	SAD6	SAD5	SAD4	00H
F0H	R/W	B	B7	B6	B5	B4	B3	B2	B1	B0	00H
F8H	R/W	TXT13	(reserved) 0	PAGE CLEARING	525 DISPLAY	(reserved) 0	(reserved) 0	(reserved) 0	(reserved) 0	(reserved) 0	XXXX XXXX
FAH	R/W	XRAMP	XRAMP7	XRAMP6	XRAMP5	XRAMP4	XRAMP3	XRAMP2	XRAMP1	XRAMP0	00H
FBH	R/W	ROMBK	STANDBY	0	0	0	0	0	(reserved) 0	(reserved) 0	00H
FEH	W	WDTKEY	WKEY7	WKEY6	WKEY5	WKEY4	WKEY3	WKEY2	WKEY1	WKEY0	00H
FFH	R/W	WDT	WDV7	WDV6	WDV5	WDV4	WDV3	WDV2	WDV1	WDV0	00H

TV microcontrollers with Closed Captioning (CC) and On-Screen Display (OSD)

SAA55xx

Table 3 SFR bit description

BIT	FUNCTION
Accumulator (ACC)	
ACC7 to ACC0	accumulator value
B Register (B)	
B7 to B0	B register value
CC data byte 1 (CCDAT1)	
CCD17 to CCD10	closed caption first data byte
CC data byte 2 (CCDAT2)	
CCD26 to CCD20	closed caption second data byte
CC line (CCLIN)	
CS4 to CS0	closed caption slice line using 525-line number
Data Pointer High byte (DPH)	
DPH7 to DPH0	data pointer high byte, used with DPL to address auxiliary memory
Data pointer Low byte (DPL)	
DPL7 to DPL0	data pointer low byte, used with DPH to address auxiliary memory
Interrupt Enable Register (IE)	
EA	disable all interrupts (logic 0), or use individual interrupt enable bits (logic 1)
EBUSY	enable BUSY interrupt
ES2	enable I ² C-bus interrupt
ECC	enable closed caption interrupt
ET1	enable Timer 1 interrupt
EX1	enable external interrupt 1
ET0	enable Timer 0 interrupt
EX0	enable external interrupt 0
Interrupt Priority Register (IP)	
PBUSY	priority EBUSY interrupt
PES2	priority ES2 Interrupt
PCC	priority ECC interrupt
PT1	priority Timer 1 interrupt
PX1	priority external interrupt 1
PT0	priority Timer 0 interrupt
PX0	priority external interrupt 0
Port 0 (P0)	
P07 to P00	Port 0 I/O register connected to external pins

TV microcontrollers with Closed Captioning (CC) and On-Screen Display (OSD)

SAA55xx

BIT	FUNCTION
Port 1 (P1)	
P17 to P10	Port 1 I/O register connected to external pins
Port 2 (P2)	
P27 to P20	Port 2 I/O register connected to external pins
Port 3 (P3)	
P37 to P30	Port 3 I/O register connected to external pins; P37 to P35 are only available with the LQFP100 package
Port 0 Configuration A (P0CFGA) and Port 0 Configuration B (P0CFGB)	
P0CFGA<7:0> and P0CFGB<7:0>	<p>These two registers are used to configure Port 0 pins. For example, the I/O configuration of Port 0 pin 3 is controlled using bit 3 in both P0CFGA and P0CFGB. P0CFGB<x>/P0CFGA<x>:</p> <ul style="list-style-type: none"> 00 = P0.x in open-drain configuration 01 = P0.x in quasi-bidirectional configuration 10 = P0.x in high-impedance configuration 11 = P0.x in push-pull configuration
Port 1 Configuration A (P1CFGA) and Port 1 Configuration B (P1CFGB)	
P1CFGA<7:0> and P1CFGB<7:0>	<p>These two registers are used to configure Port 1 pins. For example, the I/O configuration of Port 1 pin 3 is controlled using bit 3 in both P1CFGA and P1CFGB. P1CFGB<x>/P1CFGA<x>:</p> <ul style="list-style-type: none"> 00 = P1.x in open-drain configuration 01 = P1.x in quasi-bidirectional configuration 10 = P1.x in high-impedance configuration 11 = P1.x in push-pull configuration
Port 2 Configuration A (P2CFGA) and Port 2 Configuration B (P2CFGB)	
P2CFGA<7:0> and P2CFGB<7:0>	<p>These two registers are used to configure Port 2 pins. For example, the I/O configuration of Port 2 pin 3 is controlled by using bit 3 in both P2CFGA and P2CFGB. P2CFGB<x>/P2CFGA<x>:</p> <ul style="list-style-type: none"> 00 = P2.x in open-drain configuration 01 = P2.x in quasi-bidirectional configuration 10 = P2.x high-impedance configuration 11 = P2.x push-pull configuration
Port 3 Configuration A (P3CFGA) and Port 3 Configuration B (P3CFGB)	
P3CFGA<7:0> and P3CFGB<7:0>	<p>These two registers are used to configure Port 3 pins. For example, the I/O configuration of Port 3 pin 3 is controlled using bit 3 in both P3CFGA and P3CFGB. P3CFGB<x>/P3CFGA<x>:</p> <ul style="list-style-type: none"> 00 = P3.x in open-drain configuration 01 = P3.x in quasi-bidirectional configuration 10 = P3.x in high-impedance configuration 11 = P3.x in push-pull configuration

TV microcontrollers with Closed Captioning (CC) and On-Screen Display (OSD)

SAA55xx

BIT	FUNCTION
Power Control Register (PCON)	
ARD	auxiliary RAM disable, all MOVX instructions access the external data memory
RFI	disable ALE during internal access to reduce radio frequency interference
WLE	Watchdog Timer enable
GF1	general purpose flag
GF0	general purpose flag
PD	Power-down mode activation bit
IDL	Idle mode activation bit
Program Status Word (PSW)	
C	carry bit
AC	auxiliary carry bit
F0	flag 0, general purpose flag
RS1 to RS0	register bank selector bits; RS<1:0>: 00 = Bank 0 (00H to 07H) 01 = Bank 1 (08H to 0FH) 10 = Bank 2 (10H to 17H) 11 = Bank 3 (18H to 1FH)
OV	overflow flag
P	parity bit
Pulse Width Modulator 0 Control Register (PWM0)	
PW0E	activate this PWM (logic 1)
PW0V5 to PW0V0	pulse width modulator high time
Pulse Width Modulator 1 Control Register (PWM1)	
PW1E	activate this PWM (logic 1)
PW1V5 to PW1V0	pulse width modulator high time
Pulse Width Modulator 2 Control Register (PWM2)	
PW2E	activate this PWM (logic 1)
PW2V5 to PW2V0	pulse width modulator high time
Pulse Width Modulator 3 Control Register (PWM3)	
PW3E	activate this PWM (logic 1)
PW3V5 to PW3V0	pulse width modulator high time
Pulse Width Modulator 4 Control Register (PWM4)	
PW4E	activate this PWM (logic 1)
PW4V5 to PW4V0	pulse width modulator high time
Pulse Width Modulator 5 Control Register (PWM5)	
PW5E	activate this PWM (logic 1)
PW5V5 to PW5V0	pulse width modulator high time

TV microcontrollers with Closed Captioning (CC) and On-Screen Display (OSD)

SAA55xx

BIT	FUNCTION
Pulse Width Modulator 6 Control Register (PWM6)	
PW6E	activate this PWM (logic 1)
PW6V5 to PW6V0	pulse width modulator high time
Pulse Width Modulator 7 Control Register (PWM7)	
PW7E	activate this PWM (logic 1)
PW7V5 to PW7V0	pulse width modulator high time
ROM Bank (ROMBK)	
STBY	Standby mode enabled (logic 1)
I²C-bus Slave Address Register (S1ADR)	
ADR6 to ADR0	I ² C-bus slave address to which the device will respond
GC	enable I ² C-bus general call address (logic 1)
I²C-bus Control Register (S1CON)	
CR2 to CR0	clock rate bits; CR<2:0>: 000 = 100 kHz bit rate 001 = 3.75 kHz bit rate 010 = 150 kHz bit rate 011 = 200 kHz bit rate 100 = 25 kHz bit rate 101 = 1.875 kHz bit rate 110 = 37.5 kHz bit rate 111 = 50 kHz bit rate
ENSI	enable I ² C-bus interface (logic 1)
STA	START flag. When this bit is set in slave mode, the hardware checks the I ² C-bus and generates a START condition if the bus is free or after the bus becomes free. If the device operates in master mode it will generate a repeated START condition.
STO	STOP flag. If this bit is set in a master mode a STOP condition is generated. A STOP condition detected on the I ² C-bus clears this bit. This bit may also be set in slave mode in order to recover from an error condition. In this case no STOP condition is generated to the I ² C-bus, but the hardware releases the SDA and SCL lines and switches to the not selected receiver mode. The STOP flag is cleared by the hardware.

TV microcontrollers with Closed Captioning (CC) and On-Screen Display (OSD)

SAA55xx

BIT	FUNCTION
SI	<p>Serial Interrupt flag. This flag is set and an interrupt request is generated, after any of the following events occur:</p> <ul style="list-style-type: none"> • A START condition is generated in master mode • The own slave address has been received during AA = 1 • The general call address has been received while S1ADR.GC and AA = 1 • A data byte has been received or transmitted in master mode (even if arbitration is lost) • A data byte has been received or transmitted as selected slave • A STOP or START condition is received as selected slave receiver or transmitter. While the SI flag is set, SCL remains LOW and the serial transfer is suspended. SI must be reset by software.
AA	<p>Assert Acknowledge flag. When this bit is set, an acknowledge is returned after any one of the following conditions:</p> <ul style="list-style-type: none"> • Own slave address is received • General call address is received (S1ADR.GC = 1) • A data byte is received, while the device is programmed to be a master receiver • A data byte is received, while the device is selected slave receiver. <p>When the bit is reset, no acknowledge is returned. Consequently, no interrupt is requested when the own address or general call address is received.</p>
I²C-bus Data Register (S1DAT)	
DAT7 to DAT0	I ² C-bus data
I²C-bus Status Register (S1STA)	
STAT4 to STAT0	I ² C-bus interface status
Software ADC Register (SAD)	
VHI	analog input voltage greater than DAC voltage (logic 1)
CH1 to CH0	ADC input channel select; CH<1:0>: 00 = ADC3 01 = ADC0 10 = ADC1 11 = ADC2
ST ⁽¹⁾	initiate voltage comparison between ADC input channel and SAD value
SAD7 to SAD4	4 MSBs of DAC input word
Software ADC Control Register (SADB)	
DC_COMP	enable DC comparator mode (logic 1)
SAD3 to SAD0	4 LSBs of SAD value
Stack Pointer (SP)	
SP7 to SP0	stack pointer value

TV microcontrollers with Closed Captioning (CC) and On-Screen Display (OSD)

SAA55xx

BIT	FUNCTION
Timer/Counter Control Register (TCON)	
TF1	Timer 1 overflow flag. Set by hardware on timer/counter overflow. Cleared by hardware when processor vectors to interrupt routine.
TR1	Timer 1 run control bit. Set/cleared by software to turn timer/counter on/off.
TF0	Timer 0 overflow flag. Set by hardware on timer/counter overflow. Cleared by hardware when processor vectors to interrupt routine.
TR0	Timer 0 run control bit. Set/cleared by software to turn timer/counter on/off.
IE1	Interrupt 1 edge flag (both edges generate flag). Set by hardware when external interrupt edge detected. Cleared by hardware when interrupt processed.
IT1	Interrupt 1 type control bit. Set/cleared by software to specify edge/LOW level triggered external interrupts.
IE0	Interrupt 0 edge I flag. Set by hardware when external interrupt edge detected. Cleared by hardware when interrupt processed.
IT0	Interrupt 0 type flag. Set/cleared by software to specify falling edge/LOW level triggered external interrupts.
14-bit PWM MSB Register (TDACH)	
TPWE	activate this 14-bit PWM (logic 1)
TD13 to TD8	6 MSBs of 14-bit number to be output by the 14-bit PWM
14-bit PWM LSB Register (TDACL)	
TD7 to TD0	8 LSBs of 14-bit number to be output by the 14-bit PWM
Timer 0 High byte (TH0)	
TH07 to TH00	Timer 0 high byte
Timer 1 High byte (TH1)	
TH17 to TH10	Timer 1 high byte
Timer 0 Low byte (TL0)	
TL07 to TL00	Timer 0 low byte
Timer 1 Low byte (TL1)	
TL17 to TL10	Timer 1 low byte
Timer/Counter Mode Control (TMOD)	
GATE	gating control Timer/Counter 1
C/ \bar{T}	Counter/Timer 1 selector
M1 to M0	mode control bits timer/counter 1; M<1:0>: 00 = 8-bit timer or 8-bit counter with divide-by-32 prescaler 01 = 16-bit time interval or event counter 10 = 8-bit time interval or event counter with automatic reload upon overflow; reload value stored in TH1 11 = stopped
GATE	gating control Timer/Counter 0
C/ \bar{T}	Counter/Timer 0 selector

TV microcontrollers with Closed Captioning (CC) and On-Screen Display (OSD)

SAA55xx

BIT	FUNCTION
M1 to M0	mode control bits timer/counter 0; M<1:0>: 00 = 8-bit timer or 8-bit counter with divide-by-32 prescaler 01 = 16-bit time interval or event counter 10 = 8-bit time interval or event counter with automatic reload upon overflow; reload value stored in TH0 11 = one 8-bit time interval or event counter and one 8-bit time interval counter
Text Register 0 (TXT0)	
AUTO FRAME	frame output is switched off automatically if any video displayed (logic 1)
DISABLE FRAME	force frame output to be LOW (logic 1)
Text Register 1 (TXT1)	
FIELD POLARITY	VSYNC pulse in second half of line during even field (logic 1)
H POLARITY	HSYNC reference edge is negative going (logic 1)
V POLARITY	VSYNC reference edge is negative going (logic 1)
Text Register 4 (TXT4)	
OSD BANK ENABLE	alternate OSD location available via graphic attribute, additional 32 location (logic 1)
QUAD WIDTH ENABLE	enable display of quadruple width characters (logic 1)
EAST/WEST	eastern character selection of character codes A0H to FFH (logic 1)
DISABLE DOUBLE HEIGHT	disable normal decoding of double height characters (logic 1)
B MESH ENABLE	enable meshing of black background (logic 1)
C MESH ENABLE	enable meshing of coloured background (logic 1)
TRANS ENABLE	display black background as video (logic 1)
SHADOW ENABLE	display shadow/fringe (default SE black) (logic 1)
Text Register 5 (TXT5)	
BKGND OUT	background colour displayed outside teletext boxes (logic 1)
BKGND IN	background colour displayed inside teletext boxes (logic 1)
COR OUT	COR active outside teletext and OSD boxes (logic 1)
COR IN	COR active inside teletext and OSD boxes (logic 1)
TEXT OUT	text displayed outside teletext boxes (logic 1)
TEXT IN	text displayed inside teletext boxes (logic 1)
PICTURE ON OUT	video displayed outside teletext boxes (logic 1)
PICTURE ON IN	video displayed inside teletext boxes (logic 1)
Text Register 6 (TXT6)	
BKGND OUT	background colour displayed outside teletext boxes (logic 1)
BKGND IN	background colour displayed inside teletext boxes (logic 1)
COR OUT	COR active outside teletext and OSD boxes (logic 1)
COR IN	COR active inside teletext and OSD boxes (logic 1)
TEXT OUT	text displayed outside teletext boxes (logic 1)
TEXT IN	text displayed inside teletext boxes (logic 1)
PICTURE ON OUT	video displayed outside teletext boxes (logic 1)

TV microcontrollers with Closed Captioning (CC) and On-Screen Display (OSD)

SAA55xx

BIT	FUNCTION
PICTURE ON IN	video displayed inside teletext boxes (logic 1)
Text Register 7 (TXT7)	
CURSOR ON	display cursor at position given by TXT9 and TXT10 (logic 1)
DOUBLE HEIGHT	display each character as twice normal height (logic 1)
BOX ON 24	enable display of teletext boxes in memory row 24 (logic 1)
BOX ON 1 – 23	enable display of teletext boxes in memory row 1 to 23 (logic 1)
BOX ON 0	enable display of teletext boxes in memory row 0 (logic 1)
Text Register 8 (TXT8)	
FLICKER STOP ON	disable 'Flicker Stopper' circuitry (logic 1)
DISABLE SPANISH	disable special treatment of Spanish packet 26 characters (logic 1)
PKT 26 RECEIVED ⁽²⁾	packet 26 data has been processed (logic 1)
WSS RECEIVED ⁽²⁾	wide screen signalling data has been processed (logic 1)
WSS ON	enable acquisition of WSS data (logic 1)
CVBS1/CVBS0	select CVBS1 as source for device (logic 1)
Text Register 9 (TXT9)	
CURSOR FREEZE	lock cursor at current position (logic 1)
CLEAR MEMORY ⁽¹⁾	clear memory block pointed to by TXT15
R4 to R0 ⁽²⁾	current memory row value
Text Register 10 (TXT10)	
C5 to C0 ⁽³⁾	current memory column value
Text Register 11 (TXT11)	
D7 to D0	data value written or read from memory location defined by TXT9, TXT10 and TXT15
Text Register 12 (TXT12)	
525/625 SYNC ⁽⁴⁾	525-line CVBS signal is being received (logic 1)
ROM VER4 to ROM VER0	mask programmable identification for character set
VIDEO SIGNAL QUALITY	acquisition can be synchronised to CVBS (logic 1)
Text Register 13 (TXT13)	
PAGE CLEARING	software or power-on page clear in progress (logic 1)
525 DISPLAY	525-line synchronisation for display (logic 1)
Text Register 17 (TXT17)	
FORCE ACQ1 to FORCE ACQ0	FORCE ACQ<1:0>: 00 = automatic selection 01 = force 525 timing, force 525 teletext standard 10 = force 625 timing, force 625 teletext standard 11 = force 625 timing, force 525 teletext standard

TV microcontrollers with Closed Captioning (CC) and On-Screen Display (OSD)

SAA55xx

BIT	FUNCTION
FORCE DISP1 to FORCE DISP0	FORCE DISP<1:0>: 00 = automatic selection 01 = force display to 525 mode (9 lines per row) 10 = force display to 625 mode (10 lines per row) 11 = not valid (default to 625 mode)
SCREEN COL2 to SCREEN COL0	Defines colour to be displayed instead of TV picture and black background; these bits are equivalent to the RGB components. SCREEN COL<2:0>: 000 = transparent 001 = CLUT entry 9 010 = CLUT entry 10 011 = CLUT entry 11 100 = CLUT entry 12 101 = CLUT entry 13 110 = CLUT entry 14 111 = CLUT entry 15
Text Register 18 (TXT18)	
NOT3 to NOT0	national option table selection, maximum of 31 when used with EAST/WEST bit
BS1 to BS0	basic character set selection
Text Register 19 (TXT19)	
TEN	enable twist character set (logic 1)
TC2 to TC0	language control bits (C12, C13 and C14) that has twisted character set
TS1 to TS0	twist character set selection
Text Register 20 (TXT20)	
DRCS ENABLE	re-map column 9 to DRCS in TXT mode (logic 1)
OSD PLANES	character code columns 8 and 9 defined as double plane characters (logic 1)
OSD LANG ENABLE	enable use of OSD LAN<2:0> to define language option for display, instead of C12, C13 and C14
OSD LAN2 to OSD LAN0	alternative C12, C13 and C14 bits for use with OSD menus
Text Register 21 (TXT21)	
DISP LINES1 to DISP LINES0	the number of display lines per character row; DISP LINES<1:0>: 00 = 10 lines per character (defaults to 9 lines in 525 mode) 01 = 13 lines per character 10 = 16 lines per character 11 = reserved (logic 1)
CHAR SIZE1 to CHAR SIZE0	character matrix size; CHAR SIZE<1:0>: 00 = 10 lines per character (matrix 12 × 10) 01 = 13 lines per character (matrix 12 × 13) 10 = 16 lines per character (matrix 12 × 16) 11 = reserved
I ² C PORT 1	enable I ² C-bus Port 1 selection (P1.5/SDA1 and P1.4/SCL1) (logic 1)

TV microcontrollers with Closed Captioning (CC) and On-Screen Display (OSD)

SAA55xx

BIT	FUNCTION
CC ON	closed caption acquisition on (logic 1)
I ² C PORT 0	enable I ² C-bus Port 0 selection (P1.7/SDA0 and P1.6/SCL0) (logic 1)
CC/TXT	display configured for CC mode (logic 1)
Text Register 22 (TXT22)	
GPF7 to GPF5	general purpose register, bits defined by mask programmable bits
GPF4	reserved
GPF3	PWM0, PWM1, PWM2 and PWM3 output on Port 2.1 to Port 2.4 respectively (logic 1)
GPF2	enable closed caption acquisition (logic 1)
GPF1 and GPF0	reserved
Watchdog Timer (WDT)	
WDV7 to WDV0	Watchdog Timer period
Watchdog Timer Key (WDTKEY)	
WKEY7 to WKEY0 ⁽⁵⁾	Watchdog Timer Key value
XRAMP	
XRAMP7 to XRAMP0	internal RAM access upper byte address

Notes

1. This flag is set by software and reset by hardware.
2. Valid range TXT mode 0 to 24.
3. Valid range TXT mode 0 to 39.
4. Only valid when VIDEO SIGNAL QUALITY is set.
5. Must be set to 55H to disable Watchdog Timer when active.

TV microcontrollers with Closed Captioning (CC) and On-Screen Display (OSD)

SAA55xx

8.5 Character set feature bits

Features available on the OSD only devices are reflected in a specific area of the Character ROM. These sections of the Character ROM are mapped to two Special Function Registers: TXT22 and TXT12. Character ROM address 09FEH is mapped to SFR TXT22 as shown in Table 4. Character ROM address 09FFH is mapped to SFR TXT12 as shown in Table 6.

Table 4 Character ROM - TXT22 mapping

U = used; X = reserved

MAPPED ITEMS	11	10	9	8	7	6	5	4	3	2	1	0
Character ROM address 09FEH	X	X	X	X	X	X	X	X	U	U	X	X
Mapped to TXT22	–	–	–	–	7	6	5	4	3	2	1	0

Table 5 Description of Character ROM address 09FEH bits

BIT	DESCRIPTION
0 to 1	reserved; normally all set to logic 1
2	1 = enable CC acquisition 0 = disable CC acquisition
3	1 = PWM0, PWM1, PWM2 and PWM3 output routed to Port 2.1 to Port 2.4 respectively 0 = PWM0, PWM1, PWM2 and PWM3 output routed to Port 3.0 to Port 3.3 respectively
4 to 11	reserved; normally all set to logic 1

Table 6 Character ROM - TXT12 mapping

U = used; X = reserved

MAPPED ITEMS	11	10	9	8	7	6	5	4	3	2	1	0
Character ROM address 09FFH	X	X	X	X	X	X	X	X	X	X	X	X
Mapped to TXT12	–	–	–	–	–	–	–	6	5	4	3	2

Table 7 Description of Character ROM address 09FFH bits

BIT	DESCRIPTION
0 to 11	reserved; normally all set to logic 1

TV microcontrollers with Closed Captioning (CC) and On-Screen Display (OSD)

SAA55xx

8.6 External (auxiliary) memory

The normal 80C51 external memory area has been mapped internally to the device, this means that the MOVX instruction accesses memory internal to the device.

8.6.1 AUXILIARY RAM PAGE SELECTION

The Auxiliary RAM page pointer is used to select one of the 256 pages within the Auxiliary RAM, not all pages are allocated; refer to Fig.9 for further detail. A page consists of 256 consecutive bytes.

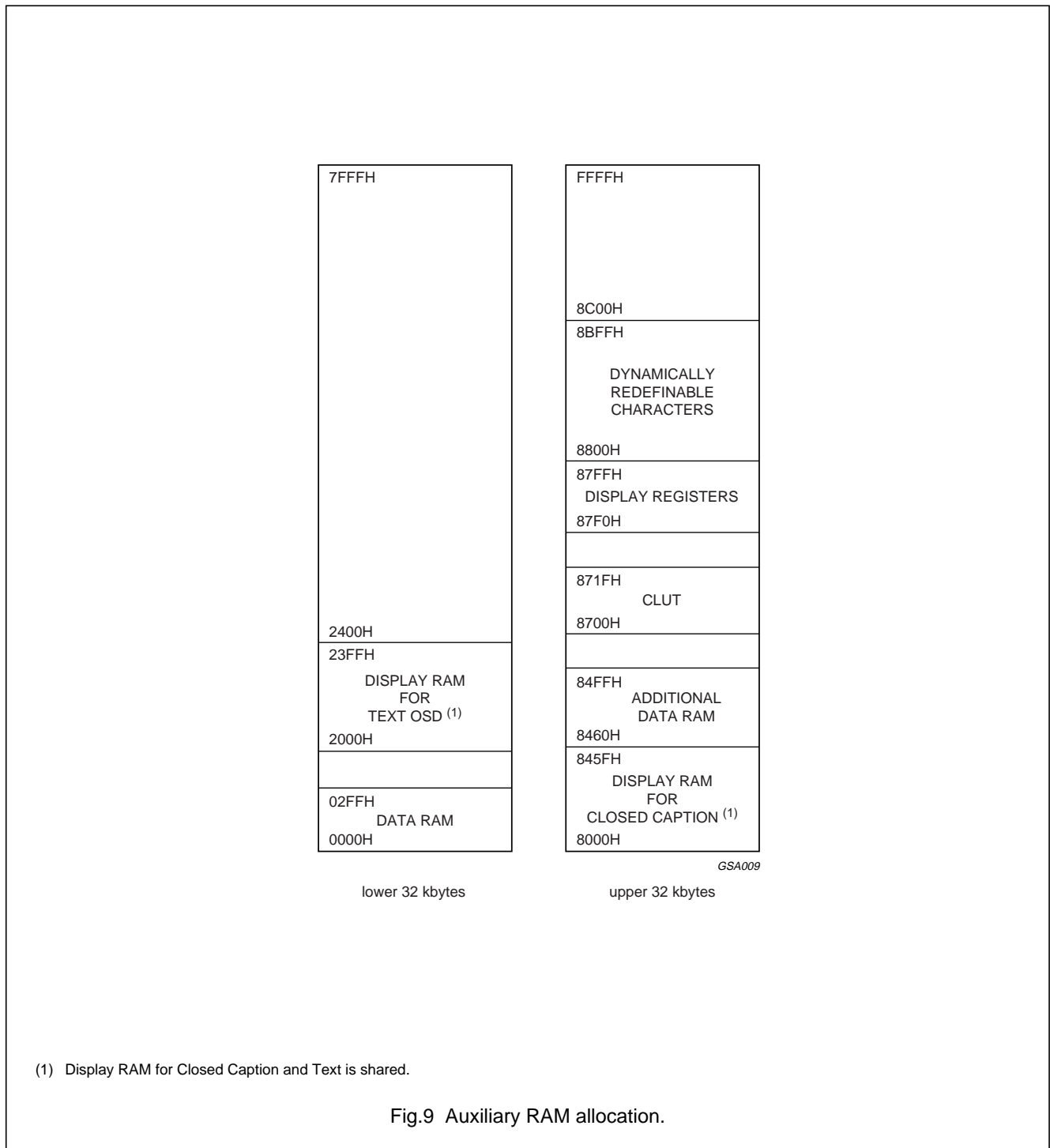

TV microcontrollers with Closed Captioning (CC)
and On-Screen Display (OSD)

SAA55xx

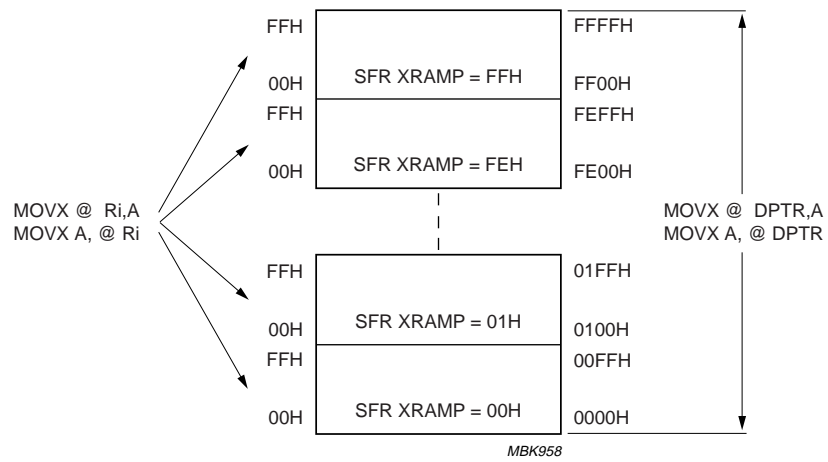

Fig.10 Indirect addressing of Auxiliary RAM.

TV microcontrollers with Closed Captioning (CC) and On-Screen Display (OSD)

SAA55xx

9 REDUCED POWER MODES

There are three power saving modes: Standby, Idle and Power-down, incorporated into the OSD only device. When utilizing any of these modes, power to the device (V_{DDP} , V_{DDC} and V_{DDA}) should be maintained, since power saving is achieved by clock gating on a section by section basis.

9.1 Idle mode

During Idle mode, Acquisition, Display and the Central Processing Unit (CPU) sections of the device are disabled. The following functions remain active:

- Memory interface
- I²C-bus interface
- Timer/Counters
- Watchdog Timer
- Pulse Width Modulators.

To enter Idle mode the IDL bit in the PCON register must be set. The Watchdog Timer must be disabled prior to entering the Idle mode to prevent the device being reset. Once in Idle mode, the crystal oscillator continues to run, but the internal clock to the CPU, Acquisition and Display are gated out. However, the clocks to the Memory interface, I²C-bus interface, timer/counters, Watchdog Timer and Pulse Width Modulators are maintained. The CPU state is frozen along with the status of all SFRs, internal RAM contents are maintained, as are the device output pin values.

Since the output values on Red Green Blue (RGB) and the Video Data Switch (VDS) are maintained the display output must be disabled before entering this mode.

There are three methods to recover from Idle mode:

- Assertion of an enabled interrupt will cause the IDL bit to be cleared by hardware, thus terminating Idle mode. The interrupt is serviced, and following the instruction RETI, the next instruction to be executed will be the one after the instruction that put the device into Idle mode.
- A second method of exiting the Idle mode is via an interrupt generated by the Software Analog-to-Digital (SAD) DC Compare circuit. When the device is configured in this mode, detection of an analog threshold at the input to the SAD may be used to trigger wake-up of the device i.e. TV Front Panel Key-press. As above, the interrupt is serviced, and following the instruction RETI, the next instruction to be executed will be the one following the instruction that put the device into Idle mode.

- The third method of terminating Idle mode is with an external hardware reset. Since the oscillator is running, the hardware reset need only be active for two machine cycles (24 clocks at 12 MHz) to complete the reset operation. Reset defines all SFRs and Display memory to an initialized state, but maintains all other RAM values. Code execution commences with the Program Counter set to '0000'.

9.2 Power-down mode

In Power-down mode the crystal oscillator is stopped. The contents of all SFRs and Data memory are maintained. However, the contents of the Auxiliary/Display memory are lost. The port pins maintain the values defined by their associated SFRs. Since the output values on RGB and VDS are maintained the display output must be made inactive before entering Power-down mode.

The Power-down mode is activated by setting the PD bit in the PCON register. It is advised to disable the Watchdog Timer prior to entering Power-down.

There are three methods of exiting Power-down mode:

- An external interrupt provides the first mechanism for waking from Power-down. Since the clock is stopped, external interrupts need to be set level sensitive prior to entering Power-down. The interrupt is serviced, and following the instruction RETI, the next instruction to be executed will be the one after the instruction that put the device into Power-down mode.
- A second method of exiting power-down is via an interrupt generated by the SAD DC Compare circuit. When the device is configured in this mode, detection of a certain analog threshold at the input to the SAD may be used to trigger wake-up of the device i.e. TV Front Panel Key-press. As above, the interrupt is serviced, and following the instruction RETI, the next instruction to be executed will be the one following the instruction that put the device into the Power-down.
- The third method of terminating the Power-down mode is with an external hardware reset. Reset defines all SFRs and Display memory, but maintains all other RAM values. Code execution commences with the Program Counter set to '0000'.

TV microcontrollers with Closed Captioning (CC) and On-Screen Display (OSD)

SAA55xx

9.3 Standby mode

When Standby mode is entered both Acquisition and Display sections are disabled. The following functions remain active:

- 80C51 core
- Memory interface
- I²C-bus interface
- Timer/Counters
- Watchdog Timer
- Software ADC
- Pulse Width Modulators

To enter Standby mode, the STANDBY control bit in the ROMBK SFR (bit 7) must be set. It can be used in conjunction with either Idle or Power-down modes to switch between power saving modes. This mode enables the 80C51 core to decode either IR remote commands or receive I²C-bus commands without the device being fully powered.

The Standby state is maintained upon exit from either the Idle mode or Power-down mode. No wake-up from Standby is necessary as the 80C51 core remains operational.

Since the output values on RGB and VDS are maintained the display output must be disabled before entering this mode.

10 I/O FACILITY

10.1 I/O ports

The SAA55xx devices have 29 I/O lines, each is individually addressable, or form 3 parallel 8-bit addressable ports which are Port 0, Port 1 and Port 2. Port 3 has 5-bit parallel I/Os only.

10.2 Port type

All individual ports can be programmed to function in one of four I/O configurations: open-drain, quasi-bidirectional, high-impedance and push-pull. The I/O configuration is selected using two associated Port Configuration Registers: PnCFGA and PnCFGB (where n = port number 0, 1, 2 or 3); see Table 3.

10.2.1 OPEN-DRAIN

The open-drain configuration can be used for bidirectional operation of a port. It requires an external pull-up resistor, the pull-up voltage has a maximum value of 5.5 V, to allow connection of the device into a 5 V environment.

Note that the I²C-bus ports (P1.4, P1.5, P1.6 and P1.7) can only be configured as open-drain.

10.2.2 QUASI-BIDIRECTIONAL

The quasi-bidirectional configuration is a combination of open-drain and push-pull. It requires an external pull-up resistor to V_{DDP} (nominally 3.3 V). When a signal transition from LOW-to-HIGH is output from the device, the pad is put into push-pull configuration for one clock cycle (166 ns) after which the pad goes into open-drain configuration. This configuration is used to speed up the edges of signal transitions. This is the default state of operation of the pads after reset.

10.2.3 HIGH-IMPEDANCE

The high-impedance configuration can be used for input only operation of the port. When using this configuration the two output transistors are turned off.

10.2.4 PUSH-PULL

The push-pull configuration can be used for output only. In this configuration the signal is driven to either 0 V or V_{DDP}, which is nominally 3.3 V.

10.3 Port alternative functions

Ports 1, 2 and 3 are shared with alternative functions to enable control of external devices and circuitry. The alternative functions are enabled by setting the appropriate SFR and also writing a logic 1 to the port bit that the function occupies.

10.4 LED support

Port pins P0.5 and P0.6 have a 8 mA current sinking capability to enable LEDs in series with current limiting resistors to be driven directly, without the need for additional buffering circuitry.

TV microcontrollers with Closed Captioning (CC) and On-Screen Display (OSD)

SAA55xx

11 INTERRUPT SYSTEM

The device has six interrupt sources, each of which can be enabled or disabled. When enabled each interrupt can be assigned one of two priority levels. There are four interrupts that are common to the 80C51, two of these are external interrupts (EX0 and EX1) and the other two are timer interrupts (ET0 and ET1). In addition to the conventional 80C51, one application specific interrupt is incorporated internal to the device which has following functionality:

- **Display Busy interrupt (EBUSY).** An interrupt is generated when the display enters either a Horizontal or Vertical Blanking Period. i.e. indicates when the microcontroller can update the display RAM without causing undesired effects on the screen. This interrupt can be configured in one of two modes using the MMR Configuration (address 87FFH, bit TXT/V):
 - Text Display Busy. An interrupt is generated on each active horizontal display line when the Horizontal Blanking Period is entered
 - Vertical Display Busy. An interrupt is generated on each vertical display field when the Vertical Blanking period is entered.

11.1 Interrupt enable structure

Each of the individual interrupts can be enabled or disabled by setting or clearing the relevant bit in the Interrupt Enable Register (IE). All interrupt sources can also be globally disabled by clearing the EA bit (IE.7).

11.2 Interrupt enable priority

Each interrupt source can be assigned one of two priority levels. The interrupt priorities are defined by the Interrupt Priority Register (IP). A low priority interrupt can be interrupted by a high priority interrupt, but not by another low priority interrupt. A high priority interrupt can not be interrupted by any other interrupt source. If two requests of different priority level are received simultaneously, the request with the highest priority level is serviced.

If requests of the same priority level are received simultaneously, an internal polling sequence determines which request is serviced. Thus, within each priority level there is a second priority structure determined by the polling sequence as defined in Table 8.

Table 8 Interrupt priority (within same level)

SOURCE	PRIORITY WITHIN LEVEL	INTERRUPT VECTOR
EX0	highest	0003H
ET0	–	000BH
EX1	–	0013H
ET1	–	001BH
ES2	–	002BH
EBUSY	lowest	0033H

11.3 Interrupt vector address

The processor acknowledges an interrupt request by executing a hardware generated LCALL to the appropriate servicing routine. The interrupt vector addresses for each source are shown in Table 8.

11.4 Level/edge interrupt

The external interrupt can be programmed to be either level-activated or transition-activated by setting or clearing the IT0/IT1 bits in the Timer Control SFR (TCON).

Table 9 External interrupt activation

ITx	LEVEL	EDGE
0	active LOW	–
1	–	INT0 = negative edge INT1 = positive and negative edge

The external interrupt INT1 differs from the standard 80C51 interrupt in that it is activated on both edges when in edge sensitive mode. This is to allow software pulse width measurement for handling remote control inputs.

TV microcontrollers with Closed Captioning (CC) and On-Screen Display (OSD)

SAA55xx

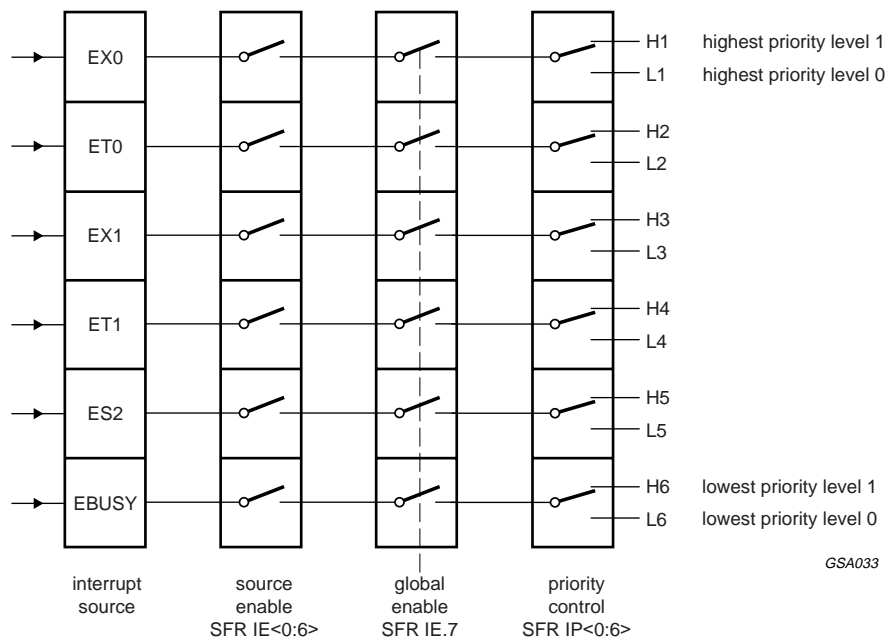

Fig.11 Interrupt structure.

TV microcontrollers with Closed Captioning (CC) and On-Screen Display (OSD)

SAA55xx

12 TIMER/COUNTER

Two 16-bit timers/counters are incorporated Timer 0 and Timer 1. Both can be configured to operate as either timers or event counters.

In Timer mode, the register is incremented on every machine cycle. It is therefore counting machine cycles. Since the machine cycle consists of twelve oscillator periods, the count rate is $\frac{1}{12}f_{osc} = 1$ MHz.

In Counter mode, the register is incremented in response to a negative transition at its corresponding external pin T0 or T1. Since the pins T0 and T1 are sampled once per machine cycle, it takes two machine cycles to recognise a transition, this gives a maximum count rate of $\frac{1}{24}f_{osc} = 0.5$ MHz.

There are six Special Function Registers used to control the timers/counters. These are: TCON, TMOD, TL0, TH0, TL1 and TH1.

The timer/counter function is selected by control bits C/T in the Timer Mode SFR (TMOD). These two Timer/Counters have four operating modes, which are selected by bit-pairs (M1 and M0) in TMOD. Detail of the modes of operation is given in *"Handbook IC20, 80C51-Based 8-bit Microcontrollers"*.

TL0 and TH0 are the actual Timer/Counter registers for Timer 0. TL0 is the low byte and TH0 is the high byte. TL1 and TH1 are the actual Timer/Counter registers for Timer 1. TL1 is the low byte and TH1 is the high byte.

13 WATCHDOG TIMER

The Watchdog Timer is a counter that once in an overflow state forces the microcontroller into a reset condition. The purpose of the Watchdog Timer is to reset the microcontroller if it enters an erroneous processor state (possibly caused by electrical noise or RFI) within a reasonable period of time. When enabled, the Watchdog circuitry will generate a system reset if the user program fails to reload the Watchdog Timer within a specified length of time known as the Watchdog Interval (WI).

The Watchdog Timer consists of an 8-bit counter with an 11-bit prescaler. The prescaler is fed with a signal whose frequency is $\frac{1}{12}f_{osc}$ (1 MHz for 12 MHz oscillator).

The 8-bit timer is incremented every 't' seconds where:

$$t = 12 \times 2048 \times \frac{1}{f_{osc}} = 12 \times 2048 \times \frac{1}{12 \times 10^6} = 2.048 \text{ ms}$$

13.1 Watchdog Timer operation

The Watchdog operation is activated when the WLE bit in the Power Control SFR (PCON) is set. The Watchdog can be disabled by software by loading the value 55H into the Watchdog Timer Key SFR (WDTKEY). This must be performed before entering the Idle or Power-down mode to prevent exiting the mode prematurely.

Once activated the Watchdog Timer SFR (WDT) must be reloaded before the timer overflows. The WLE bit must be set to enable loading of the WDT SFR, once loaded the WLE bit is reset by hardware, this is to prevent erroneous software from loading the WDT SFR.

The value loaded into the WDT defines the Watchdog Interval (WI).

$$WI = (256 - WDT) \times t = (256 - WDT) \times 2.048 \text{ ms}$$

The range of intervals is from WDT = 00H which gives 524 ms to WDT = FFH which gives 2.048 ms.

14 PULSE WIDTH MODULATORS

The device has eight 6-bit Pulse Width Modulated (PWM) outputs for analog control of e.g. volume, balance, bass, treble, brightness, contrast, hue and saturation. The PWM outputs generate pulse patterns with a repetition rate of 21.33 μ s, with the high time equal to the PWM SFR value multiplied by 0.33 μ s. The analog value is determined by the ratio of the high time to the repetition time, a D.C. voltage proportional to the PWM setting is obtained by means of an external integration network (low-pass filter).

14.1 PWM control

The relevant PWM is enabled by setting the PWM enable bit PWxE in the PWMx Control Register (where x = 0 to 7). The high time is defined by the value PWxV<5:0>.

TV microcontrollers with Closed Captioning (CC) and On-Screen Display (OSD)

SAA55xx

14.2 Tuning Pulse Width Modulator (TPWM)

The device has a single 14-bit PWM that can be used for Voltage Synthesis Tuning. The method of operation is similar to the normal PWM except that the repetition period is 42.66 μ s.

14.3 TPWM control

Two SFRs are used to control the TPWM, they are TDACL and TDACH. The TPWM is enabled by setting the TPWE bit in the TDACH SFR. The most significant bits TD<13:7> alter the high period between 0 and 42.33 μ s. The seven least significant bits TD<6:0> extend certain pulses by a further 0.33 μ s, e.g. if TD<6:0> = 01H then 1 in 128 periods will be extended by 0.33 μ s, if TD<6:0> = 02H then 2 in 128 periods will be extended.

The TPWM will not start to output a new value until TDACH has been written to. Therefore, if the value is to be changed, TDACL should be written before TDACH.

14.4 Software ADC (SAD)

Four successive approximation Analog-to-Digital Converters can be implemented in software by making use of the on-board 8-bit Digital-to-Analog Converter and Analog Comparator.

14.4.1 SAD CONTROL

The control of the required analog input is done using the channel select bits CH<1:0> in the SAD SFR, this selects the required analog input to be passed to one of the inputs of the comparator. The second comparator input is generated by the DAC whose value is set by the bits SAD<7:0> in the SAD and SADB SFRs. A comparison between the two inputs is made when the start compare bit ST in the SAD SFR is set, this must be at least one instruction cycle after the SAD<7:0> value has been set. The result of the comparison is given on VHI one instruction cycle after the setting of ST.

14.4.2 SAD INPUT VOLTAGE

The external analog voltage that is used for comparison with the internally generated DAC voltage does not have the same voltage range. The DAC has a lower reference level of V_{SSA} and an upper reference level of V_{DDP} .

The resolution of the DAC voltage with a nominal value is $3.3/256 \approx 13$ mV. The external analog voltage has a lower value equivalent to V_{SSA} and an upper value equivalent to $V_{DDP} - V_{tn}$, where V_{tn} is the threshold voltage for an N type Metal Oxide Semiconductor transistor. The reason for this is that the input pins for the analog signals (P3.0 to P3.3) are 5 V tolerant for normal port operations, i.e. when not used as analog input. To protect the analog multiplexer and comparator circuitry from the 5 V, a series transistor is used to limit the voltage. This limiting introduces a voltage drop equivalent to V_{tn} (≈ 0.6 V) on the input voltage. The maximum value of V_{tn} is 0.75 V, therefore for worst case calculations, the maximum input to the SAD should be calculated as $V_{DD(min)} - 0.75$ V. Therefore, for an input voltage in the range V_{DDP} to $V_{DDP} - V_{tn}$ the SAD returns the same comparison value.

14.4.3 SAD DC COMPARATOR MODE

The SAD module incorporates a DC Comparator mode which is selected using the DC_COMP control bit in the SADB SFR. This mode enables the microcontroller to detect a threshold crossing at the input to the selected analog input pin (P3.0/ADC0, P3.1/ADC1, P3.2/ADC2 or P3.3/ADC3) of the software ADC. A level sensitive interrupt is generated when the analog input voltage level at the pin falls below the analog output level of the SAD DAC.

This mode is intended to provide the device with a wake-up mechanism from Power-down or Idle mode when a key-press on the front panel of the TV is detected.

The following software sequence should be used when utilizing this mode for Power-down or Idle:

1. Disable INT1 using the IE SFR.
2. Set INT1 to level sensitive using the TCON SFR.
3. Set the DAC digital input level to the desired threshold level using SAD/SADB SFRs and select the required input pin (P3.0/ADC0, P3.1/ADC1, P3.2/ADC2 or P3.3/ADC3) using CH<1:0> in the SAD SFR.
4. Enter DC Compare mode by setting the DC_COMP enable bit in the SADB SFR.
5. Enable INT1 using the IE SFR.
6. Enter Power-down/Idle mode. Upon wake-up the SAD should be restored to its conventional operating mode by disabling the DC_COMP control bit.

TV microcontrollers with Closed Captioning (CC)
and On-Screen Display (OSD)

SAA55xx

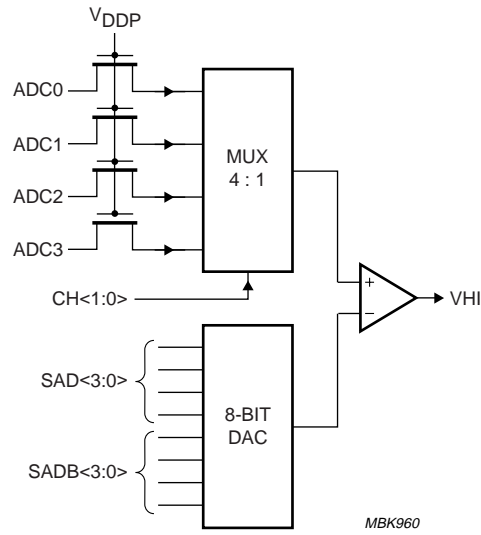

Fig.12 SAD block diagram.

TV microcontrollers with Closed Captioning (CC) and On-Screen Display (OSD)

SAA55xx

15 I²C-BUS SERIAL I/O

The I²C-bus consists of a serial data (SDA) line and a serial clock (SCL) line. The definition of the I²C-bus protocol can be found in the document "*The I²C-bus and how to use it (including specification)*". This document may be ordered using the code 9398 393 40011.

The device operates in four modes:

- Master transmitter
- Master receiver
- Slave transmitter
- Slave receiver.

The microcontroller peripheral is controlled by the Serial Control SFR (S1CON) and its status is indicated by the Status SFR (S1STA). Information is transmitted/received to/from the I²C-bus using the Data SFR (S1DAT) and the Slave Address SFR (S1ADR) is used to configure the slave address of the peripheral.

The byte level I²C-bus serial port is identical to the I²C-bus serial port on the P8xCE558, except for the clock rate selection bits CR<2:0> in S1CON. The operation of the subsystem is described in detail in the "*P8xCE558 data sheet*".

15.1 I²C-bus port selection

Two I²C-bus ports are available SCL0/SDA0 and SCL1/SDA1. The selection of the port is done using TXT21.I²C PORT 0 and TXT21.I²C PORT 1. When the port is enabled, any information transmitted from the device goes onto the enabled port. Any information transmitted to the device can only be acted on if the port is enabled.

If both ports are enabled then data transmitted from the device is seen on both ports, however data transmitted to the device on one port can not be seen on the other port.

16 MEMORY INTERFACE

The memory interface controls access to the embedded DRAM, refreshing of the DRAM and page clearing. The DRAM is shared between Data Capture, display and microcontroller sections.

The Data Capture section uses the DRAM to store acquired information that has been requested. The display reads from the DRAM information and converts it into RGB values. The microcontroller uses the DRAM as embedded auxiliary RAM.

16.1 Memory structure

The memory is partitioned into two distinct areas, the dedicated Auxiliary RAM area, and the Display RAM area. The Display RAM area when not being used for Data Capture or Display can be used as an extension to the auxiliary RAM area.

16.1.1 AUXILIARY RAM

The Auxiliary RAM is not initialised at power-up. Application software must initialize this Auxiliary RAM. The contents of the Auxiliary RAM area, and the Display RAM are maintained during Standby and Idle modes, but are lost if Power-down mode is entered.

16.1.2 DISPLAY RAM

The Display RAM (Block 0 only) is initialised on power-up to a value of 20H. The contents of the Display RAM are maintained when entering Idle mode. If Idle mode is exited using an interrupt then the contents are unchanged, if Idle mode is exited using a reset then the contents are re-initialised to 20H.

Full Closed Caption display requires a display RAM from 8000H to 845FH. The memory from 8460H to 84FFH (must be initialized by the application software) can be utilized as an extension to the dedicated contiguous Auxiliary RAM that occupies 000H to 02FFH.

16.2 Memory mapping

The dedicated Auxiliary RAM area occupies 0.75 kbytes, with an address range from 0000H to 02FFH. The Display RAM occupies 1.25 kbytes with an address range from 2000H to 24FFH for TXT mode and 8000H to 84FFH for CC mode. The two modes although having different address ranges occupy the same physical DRAM area.

The hardware will only initialize 1-kbyte (block 0) of the available 1.25 kbytes on the device. The application software must initialize this additional 0.25 kbytes if it is to be used as display RAM or auxiliary RAM.

TV microcontrollers with Closed Captioning (CC) and On-Screen Display (OSD)

SAA55xx

16.3 Addressing memory

The memory can be addressed by the microcontroller in two ways, either directly using a MOVX command, or via Special Function Registers depending on what address is required.

The dedicated Auxiliary RAM, and Display memory in the range 8000H to 84FFH, can only be accessed using the MOVX command.

The Display memory in the range 2000H to 23FFH can either be directly accessed using the MOVX, or via the Special Function Registers.

16.3.1 TXT DISPLAY MEMORY SFR ACCESS

The Display memory when in TXT mode (see Fig.14) is configured as 40 columns wide by 25 rows and occupies 1K × 8 bits of memory. The row and column is selected using TXT9.R<4:0> and TXT10.C<5:0>. The data at the selected position can be read or written using TXT11.D<7:0>.

Whenever a read or write is performed on TXT11, the row values stored in TXT9 and column value stored in TXT10 are automatically incremented. For rows 0 to 24 the column value is incremented up to a maximum of 39, at which point it resets to a logic 0 and increments the row counter value. When row 25 column 23 is reached the values of the row and column are both reset to logic 0.

Writing values outside of the valid range for TXT9 or TXT10 will cause undetermined operation of the auto-incrementing function for accesses to TXT11.

16.3.2 TXT DISPLAY MEMORY MOVX ACCESS

It is important for the generation of OSD displays, that use this mode of access, to understand the mapping of the MOVX address onto the display row and column value. This mapping of row and column onto address is shown in Table 10. The values shown are added onto a base address for the required memory block (see Fig.13) to give a 16-bit address.

Table 10 Column and row to MOVX address (lower 10 bits of address)

ROW	COL.0	...	COL.23	...	COL.31	COL.32	...	COL.39
Row 0	000H	...	017H	...	01FH	3F8H	...	3FFH
Row 1	020H	...	037H	...	03FH	3F0H	...	3F7H
...
Row 23	2E0H	...	3F7H	...	2FFH	340H	...	347H
Row 24	300H	...	317H	...	31FH	338H	...	33FH
Row 25	320H	...	337H	

16.4 Page clearing

Page clearing is performed on request from the microcontroller under the control of the embedded software.

At power-on and reset the Text Display memory (from 2000H to 23FFH) is cleared to the value of 20H. The TXT13.PAGE CLEARING bit will be set while this takes place.

16.4.1 DATA CAPTURE PAGE CLEAR

Not present in the SAA55xx OSD only devices.

16.4.2 SOFTWARE PAGE CLEAR

The software can also initiate a page clear, by setting the TXT9.CLEAR MEMORY bit. The CLEAR MEMORY bit is not latched so the software does not have to reset it after it has been set.

Only one page can be cleared in a TV line so if the software requests a page clear it will be carried out on the next TV line on which the Data Capture hardware does not force the page to be cleared. A flag, TXT13.PAGE CLEARING, is provided to indicate that a software requested page clear is being carried out. The flag is set when a logic 1 is written into the TXT9.CLEAR MEMORY bit and is reset when the page clear has been completed.

Inventory page clearing is not present in the SAA55xx OSD only devices.

TV microcontrollers with Closed Captioning (CC) and On-Screen Display (OSD)

SAA55xx

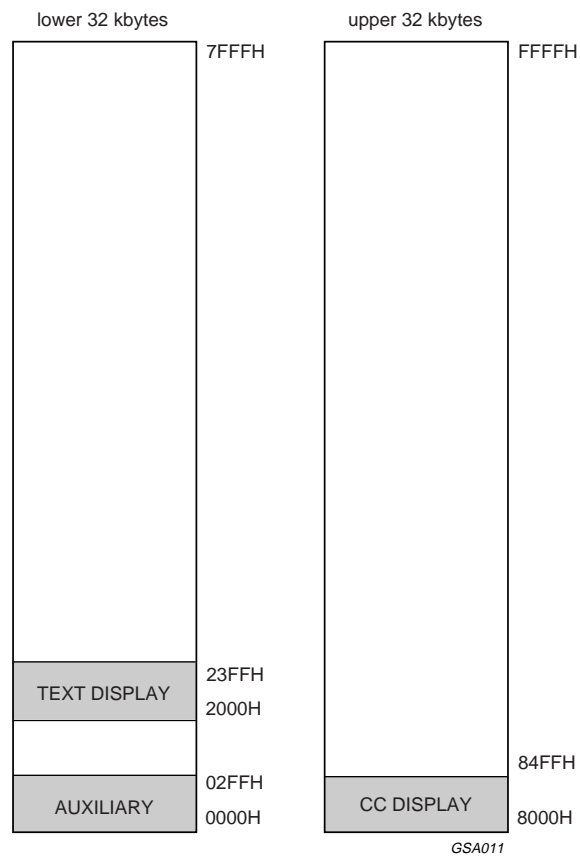
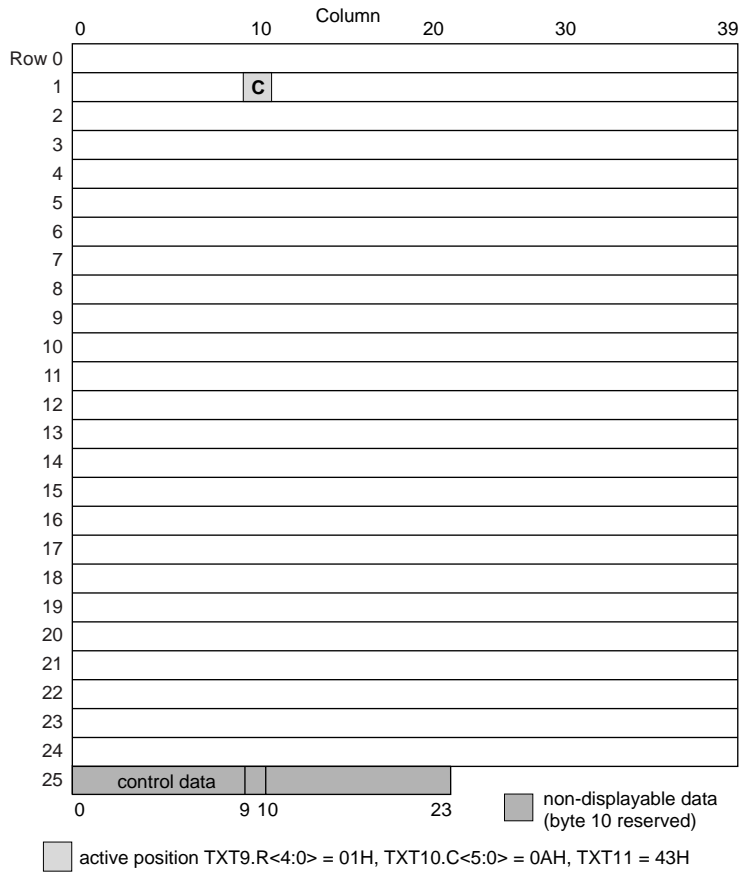

Fig.13 DRAM memory mapping.

TV microcontrollers with Closed Captioning (CC) and On-Screen Display (OSD)

SAA55xx



MBK962

Fig.14 TXT memory map.

TV microcontrollers with Closed Captioning (CC) and On-Screen Display (OSD)

SAA55xx

17 DATA CAPTURE

The Data Capture section takes in the analog Composite Video and Blanking Signal (CVBS), and from this extracts the required data, which is then decoded and stored in memory.

The extraction of the data is performed in the digital domain. The first stage is to convert the analog CVBS signal into a digital form. This is done using an ADC sampling at 12 MHz. The data and clock recovery is then performed by a Multi-Rate Video Input Processor (MuVIP). From the recovered data and clock, the serial Closed Captioning data is converted to parallel and stored as two bytes per line. The extracted data is stored in SFR locations.

17.1 Data Capture features

- Two CVBS inputs
- Data Capture for Line 21 Data Service
- Video Signal Quality Detector.

17.1.1 CVBS SWITCH

The CVBS switch is used to select the required analog input depending on the value of TXT8.CVBS1/CVBS0.

17.1.2 ANALOG-TO-DIGITAL CONVERTER

The output of the CVBS switch is passed to a differential to single ended converter, although in this device it is used in single ended configuration with a reference. The analog output of the differential to single ended converter is converted into a digital representation by a full-flash ADC with a sampling rate of 12 MHz.

17.1.3 MULTI-RATE VIDEO INPUT PROCESSOR

The multi-rate video input processor is a Digital Signal Processor designed to extract the data and recover the clock from a digitized CVBS signal. The only data and clock standard that can be recovered in the OSD only devices is Closed Caption at a data rate of approximately 503.5 kHz.

17.1.4 DATA CAPTURE TIMING

The Data Capture timing section uses the synchronisation information extracted from the CVBS signal to generate the required horizontal and vertical reference timings.

The timing section automatically recognizes and selects the appropriate timings for either 625 (50 Hz) synchronisation or 525 (60 Hz) synchronisation.

A flag TXT12.VIDEO SIGNAL QUALITY is set when the timing section is locked correctly to the incoming CVBS signal. When TXT12.VIDEO SIGNAL QUALITY is set another flag TXT12.525/625 SYNC can be used to identify the standard.

17.1.5 LINE 21 DATA SERVICES

The Line 21 Data Services is transmitted on line 21 of a 525-line broadcast system and is used for Captioning information, Text information and Extended Data Services. Full Details can be found in "*Recommended Practise for Line 21 Data Service EIA-608*".

Closed Caption Line 21 data is only acquired when TXT21.CC ON bit is set.

Two bytes of data are stored per field in SFRs, the first byte is stored in CCDAT1 and the second byte is stored in CCDAT2. The contents of each CCDAT register are reset to 00H at the start of the Closed Caption line defined by CCLIN.CS<4:0>. At the end of the Closed Caption line an interrupt is generated if IE.ECC is active.

The processing of the Closed Caption data to convert into a displayable format is performed by software.

TV microcontrollers with Closed Captioning (CC) and On-Screen Display (OSD)

SAA55xx

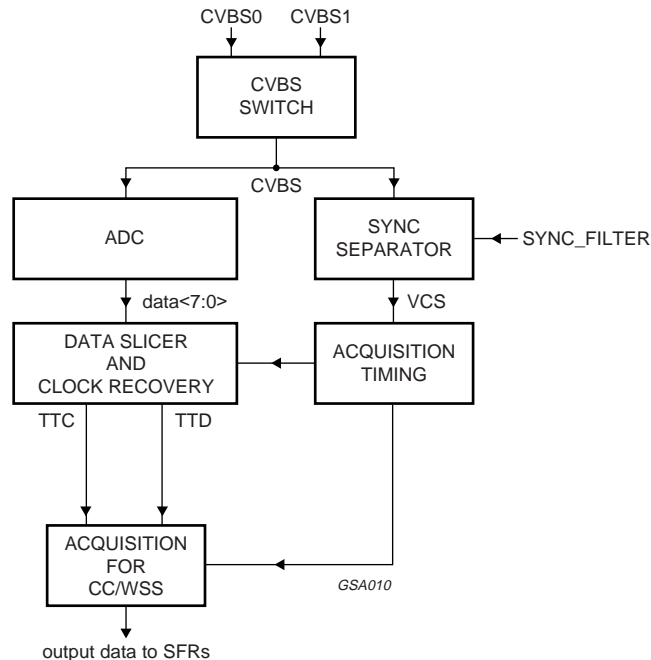

Fig.15 Data Capture block diagram.

18 DISPLAY

The display section is based on the requirements for US Closed Caption. There are some enhancements for use with locally generated On-Screen Displays.

The display section reads the contents of the Display memory and interprets the control/character codes. From this information and other global settings, the display produces the required RGB signals and video/data (Fast Blanking) signal for a TV signal processing device.

The display is synchronised to the TV signal processing device by way of horizontal and vertical sync signals provided by external circuits (Slave Sync mode). From these signals all display timings are derived.

18.1 Display features

- Teletext style OSD and Enhanced OSD modes
- US Closed Caption features
- Serial and Parallel display attributes
- Single/double/quadruple width and height for characters
- Scrolling of display region
- Variable flash rate controlled by software
- Globally selectable scan lines per row 9, 10, 13 or 16
- Globally selectable character matrix (H × V) 12 × 9, 12 × 10, 12 × 13 or 12 × 16
- Italics
- Soft colours using CLUT with 4096 colour palette
- Underline
- Overline
- Fringing (shadow) selectable from N-S-E-W direction
- Fringe colour selectable
- Meshing of defined area
- Contrast reduction of defined area
- Cursor
- Special Graphics characters with two planes, allowing four colours per character
- 32 software redefinable On-Screen Display characters
- 4 WST character sets (G0/G2) in single device (e.g. Latin, Cyrillic, Greek, Arabic)
- G1 Mosaic graphics, Limited G3 Line drawing characters
- WST character sets and Closed (including extended) Caption character set in a single device.

TV microcontrollers with Closed Captioning (CC) and On-Screen Display (OSD)

SAA55xx

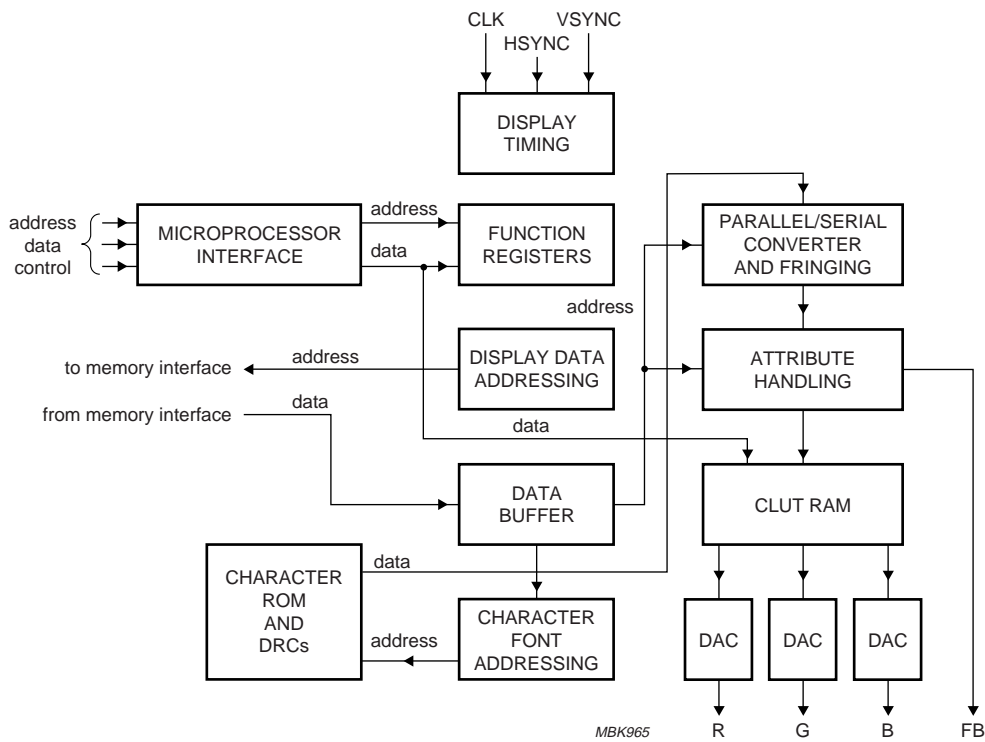

Fig.16 Display block diagram.

TV microcontrollers with Closed Captioning (CC) and On-Screen Display (OSD)

SAA55xx

18.2 Display modes

The display section has two distinct modes with different features available in each. The two modes are:

- **TXT:** This is the display configured for WST with additional serial and global attributes. The display is configured as a fixed 25 rows with 40 characters per row. In the OSD only family this mode can only be utilised for display of Text style OSD, no Teletext Data Capture is present.
- **CC:** This is the display configured as the US Closed Caption mode. The display is configured as a maximum of 16 rows with a maximum of 48 characters per row.

In both of the above modes the character matrix, and TV lines per row can be defined. There is an option of 9, 10, 13 and 16 TV lines per display row, and a character matrix (H × V) of 12 × 9, 12 × 10, 12 × 13 or 12 × 16. Not all combinations of TV lines per row and maximum display rows give a sensible OSD display, since there is a limited number of TV scan lines available.

Special Function Register TXT21 and memory mapped registers are used to control the mode selection.

18.3 Display feature descriptions

All display features are now described in detail for both TXT and CC modes.

18.3.1 FLASH

Flashing causes the foreground colour pixel to be displayed as the background pixels. The flash frequency is controlled by software setting and resetting the MMR Status (see Table 28) at the appropriate interval.

CC: This attribute is valid from the time set (see Table 16) until the end of the row or until otherwise modified.

TXT: This attribute is set by the control character 'flash' (08H) and remains valid until the end of the row or until reset by the control character 'steady' (09H).

18.3.2 BOXES

CC: This attribute is valid from the time set until end of row or otherwise modified if set with Serial Mode 0. If set with Serial Mode 1, then it is set from the next character onwards.

In Text mode (within CC mode) the background colour is displayed regardless of the setting of the box attribute bit. Boxes take effect only during mixed mode, where boxes are set in this mode the background colour is displayed. Character locations where boxes are not set show video/screen colour (depending on the setting in the MMR Display Control) instead of the background colour.

TXT: Two types of boxes exist, the teletext box and the OSD box. The teletext box is activated by the 'start box' control character (0BH). Two start box characters are required to begin a teletext box, with the box starting between the 2 characters. The box ends at the end of the line or after a 'end box' control character.

TXT mode can also use OSD boxes, they are started using size, implying OSD control characters (BCH, BDH, BEH and BFH). The box starts after the control character (set after) and ends either at the end of the row or at the next size implying OSD character (set at).

The attributes flash, teletext box, conceal, separate graphics, twist and hold graphics are all reset at the start of an OSD box, as they are at the start of the row. OSD boxes are only valid in TV mode which is defined by TXT5 = 03H and TXT6 = 03H.

TV microcontrollers with Closed Captioning (CC) and On-Screen Display (OSD)

SAA55xx

18.3.3 SIZE

The size of the characters can be modified in both the horizontal and vertical directions.

CC: Two sizes are available in both the horizontal and vertical directions. The sizes available are normal (×1), double (×2) height/width and any combination of these. The attribute setting is always valid for the whole row. Mixing of sizes within a row is not possible.

TXT: Three horizontal sizes are available normal (×1), double (×2) and quadruple (×4). The control characters 'normal size' (0CH/BCH) enables normal size, the 'double width' or 'double size' (0EH/BEH/0FH/BFH) enables double width characters.

Any two consecutive combination of 'double width' or 'double size' (0EH/BEH/0FH/BFH) activates quadruple width characters, provided quadruple width characters are enabled by TXT4.QUAD WIDTH ENABLE.

Three vertical sizes are available normal (×1), double (×2) and quadruple (×4). The control characters 'normal size' (0CH/BCH) enable normal size, the 'double height' or 'double size' (0DH/BDH/0FH/BFH) enable double height characters. Quadruple height characters are achieved by using double height characters and setting the global attributes TXT7.DOUBLE HEIGHT (expand) and TXT7.BOTTOM/TOP.

If double height characters are used in Teletext mode, single height characters in the lower row of the double height character are automatically disabled.

18.3.4 ITALIC

CC: This attribute is valid from the time set until the end of the row or otherwise modified. The attribute causes the character foreground pixels to be offset horizontally by 1 pixel per 4 scan lines (interlaced mode). The base is the bottom left character matrix pixel. The pattern of the character is indented as shown in Fig.17.

TXT: The Italic attribute is not available.

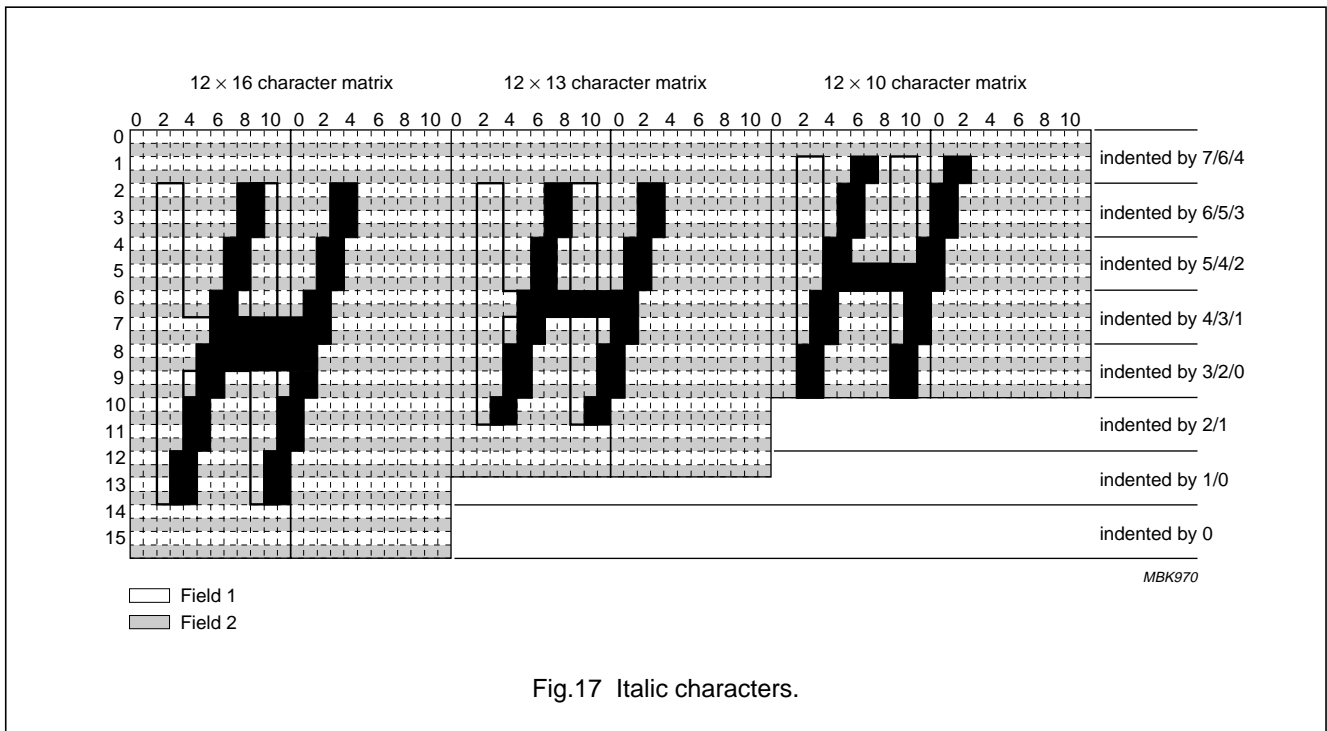

TV microcontrollers with Closed Captioning (CC) and On-Screen Display (OSD)

SAA55xx

18.3.5 COLOURS

A CLUT (Colour Look-Up Table) with 16 colour entries is provided. The colours are programmable out of a palette of 4096 (4 bits per R, G and B). The CLUT is defined by writing data to a RAM that resides in the MOVX address space of the 80C51.

Table 11 CLUT colour values

RED<3:0> (B11 TO B8)	GREEN<3:0> >(B7 TO B4)	BLUE<3:0> (B3 TO B0)	COLOUR ENTRY
0000	0000	0000	0
0000	0000	1111	1
....
1111	1111	0000	14
1111	1111	1111	15

18.3.6 FOREGROUND COLOUR

CC: The foreground colour can be chosen from 8 colours on a character-by-character basis. Two sets of 8 colours are provided. A serial attribute switches between the banks (see Table 16, Serial Mode 1, bit 7). The colours are the CLUT entries 0 to 7 or 8 to 15.

TXT: The foreground colour is selected via a control character (see Table 16). The colour control characters take effect at the start of the next character (set-after) and remain valid until the end of the row, or until modified by a control character. Only 8 foreground colours are available.

The text foreground control characters map to the CLUT entries is shown in Table 12.

Table 12 Foreground CLUT mapping

CONTROL CODE	DEFINED COLOUR	CLUT ENTRY
00H	black	0
01H	red	1
02H	green	2
03H	yellow	3
04H	blue	4
05H	magenta	5
06H	cyan	6
07H	white	7

18.3.7 BACKGROUND COLOUR

CC: This attribute is valid from the time set until end of row or otherwise modified if set with Serial Mode 0. If set with Serial Mode 1, then the colour is set from the next character onwards.

The background colour can be chosen from all 16 CLUT entries.

TXT: The control character 'new background' (1DH) is used to change the background colour to the current foreground colour. The selection is immediate (set at) and remains valid until the end of the row or until otherwise modified.

The Text background control characters map to the CLUT entries as shown in Table 13.

Table 13 Background CLUT mapping

CONTROL CODE	DEFINED COLOUR	CLUT ENTRY
00H + 1DH	black	8
01H + 1DH	red	9
02H + 1DH	green	10
03H + 1DH	yellow	11
04H + 1DH	blue	12
05H + 1DH	magenta	13
06H + 1DH	cyan	14
07H + 1DH	white	15

18.3.8 BACKGROUND DURATION

The attribute when set takes effect from the current position until the end of the text display defined in the MMR Text Area End.

CC: The background duration attribute (see Table 16, Serial Mode 1, bit 8) in combination with the End Of Row attribute (see Table 16, Serial Mode 1, bit 9) forces the background colour to be displayed on the row until the end of the text area is reached.

TXT: This attribute is not available.

TV microcontrollers with Closed Captioning (CC) and On-Screen Display (OSD)

SAA55xx

18.3.9 UNDERLINE

The underline attribute causes the characters to have the bottom scan line of the character cell forced to foreground colour, including spaces. If background duration is set, then underline is set until the end of the text area.

CC: The underline attribute (see Table 16, Serial Mode 0/1, bit 4) is valid from the time set until the end of row or otherwise modified.

TXT: This attribute is not available.

18.3.10 OVERLINE

The overline attribute causes the characters to have the top scan line of the character cell forced to foreground colour, including spaces. If background duration is set, then overline is set until the end of the text area.

CC: The overline attribute (see Table 16, Serial Mode 0/1, bit 5) is valid from the time set until end of row or otherwise modified. Overlining of italic characters is not possible.

TXT: This attribute is not available.

18.3.11 END OF ROW

CC: The number of characters in a row is flexible and can be determined by the end of row attribute (see Table 16, Serial Mode 1, bit 9). However, the maximum number of character positions displayed is determined by the setting of the MMR Text Position Horizontal and MMR Text Area End.

Note that when using the end of row attribute the next character location after the attribute should always be occupied by a 'space'.

TXT: This attribute is not available, row length is fixed at 40 characters.

18.3.12 FRINGING

A fringe (shadow) can be defined around characters. The fringe direction is individually selectable in any of the North, South, East and West direction using the MMR Fringing Control. The colour of the fringe can also be defined as one of the entries in the CLUT, again using MMR Fringing Control. An example of south and south-west fringing is shown in Fig.18.

CC: The fringe attribute (see Table 16, Serial Mode 0, bit 9) is valid from the time set until the end of the row or otherwise modified.

TXT: The display of fringing in TXT mode is controlled by the TXT4.SHADOW ENABLE bit.

When set, all the alphanumeric characters being displayed are shadowed, graphics characters are not shadowed.

18.3.13 MESHING

The attribute effects the background colour being displayed. Alternate pixels are displayed as the background colour or video. The structure is offset by 1 pixel from scan line to scan line, thus achieving a checker board display of the background colour and video. An example of meshing is shown in Fig.19.

CC: The setting of the MSH bit in MMR Display Control has the effect of meshing any background colour.

TXT: There are two meshing attributes one that only affects black background colours TXT4.B MESH ENABLE and a second that only affects backgrounds other than black TXT4.C MESH ENABLE. A black background is defined as CLUT entry 8, a non-black background is defined as CLUT entry 9 to 15.

18.3.14 CURSOR

The cursor operates by reversing the background and foreground colours in the character position pointed to by the active cursor position. The cursor is enabled using TXT7.CURSOR ON. When active, the row the cursor appears on is defined by TXT9.R<4:0> and the column is defined by TXT10.C<5:0>. The position of the cursor can be fixed using TXT9.CURSOR FREEZE. The cursor display is shown in Fig.20.

CC: The valid range for row is 0 to 15. The valid range for column is 0 to 47. The cursor remains rectangular at all times, its shape is not affected by italic attribute, therefore it is not advised to use the cursor with italic characters.

TXT: The valid range for row positioning is 0 to 24. The valid range for column is 0 to 39.

TV microcontrollers with Closed Captioning (CC)
and On-Screen Display (OSD)

SAA55xx

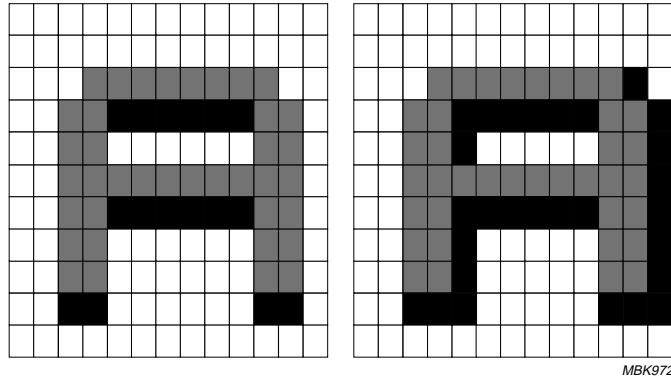

Fig.18 South and south-west fringing.

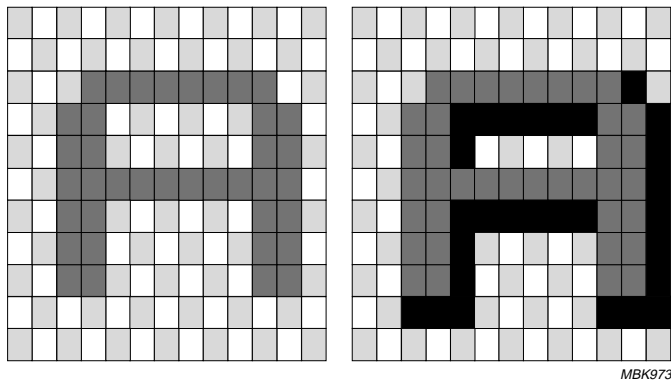

Fig.19 Meshing and Meshing/fringing (south + west).



Fig.20 Cursor display.

TV microcontrollers with Closed Captioning (CC) and On-Screen Display (OSD)

SAA55xx

18.3.15 SPECIAL GRAPHICS CHARACTERS

CC/TXT: Several special characters are provided for improved OSD effects. These characters provide a choice of four colours within a character cell. The total number of special graphics characters is limited to 16. They are stored in the character codes 8XH and 9XH of the character table (32 ROM characters), or in the DRCs which overlay character codes 8XH and 9XH. Each special graphics character uses two consecutive normal characters.

Fringing, underline and overline is not possible for special graphics characters. Special graphics characters are activated when `TXT20.OSD PLANES = 1`.

Table 14 Special character colour allocation

PLANE 1	PLANE 0	COLOUR ALLOCATION
0	0	background colour
0	1	foreground colour
1	0	CLUT entry 6
1	1	CLUT entry 7

If the screen colour is transparent (implicit in mixed mode) and inside the object the box attribute is set, then the object is surrounded by video. If the box attribute is not set the background colour inside the object will also be displayed as transparent.

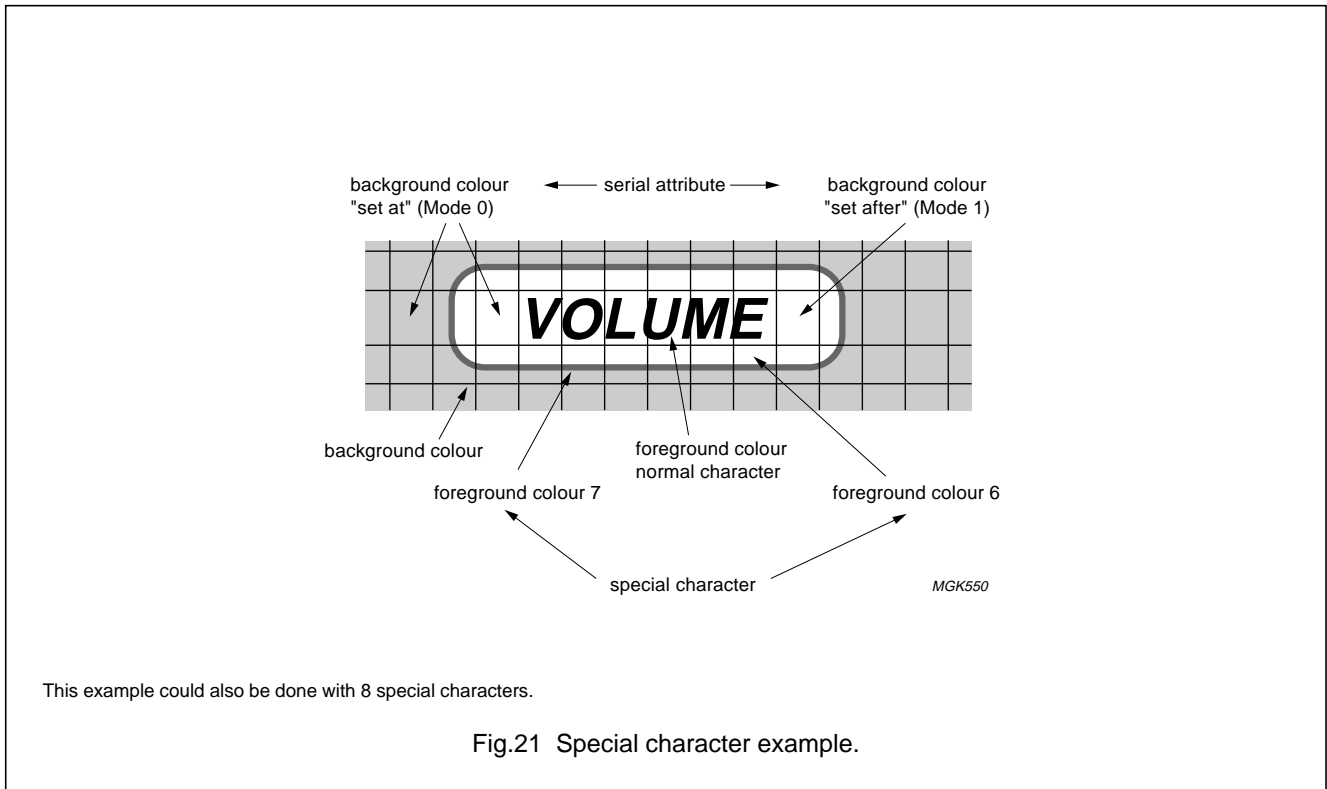

TV microcontrollers with Closed Captioning (CC) and On-Screen Display (OSD)

SAA55xx

18.4 Character and attribute coding

This section describes the character and attribute coding for each mode.

18.4.1 CC MODE

Character coding is split into character oriented attributes (parallel) and character group coding (serial). The serial attributes take effect either at the position of the attribute (set at), or at the following location (set after) and remain effective until either modified by a new serial attribute or until the end of the row. A serial attribute is represented as a space (the space character itself however is not used for this purpose), the attributes that are still active, e.g. overline and underline will be visible during the display of the space.

The default setting at the start of a row is:

- ×1 size
- Flash off
- Overline off
- Underline off
- Italics off
- Display mode = superimpose
- Fringing off
- Background colour duration = 0
- End of row = 0.

The coding is done in 12-bit words. The codes are stored sequentially in the Display memory. A maximum of 768 character positions can be defined for a single display.

Table 15 Parallel character coding

BITS	DESCRIPTION
0 to 7	8 bit character code
8 to 10	3 bits for 8 foreground colours
11	mode bit: 0 = Parallel code

18.4.2 TXT MODE

Character coding is in a serial format, with only one attribute being changed at any single location. The serial attributes take effect either at the position of the attribute (set at), or at the following location (set after). The attribute remains effective until either modified by new serial attributes or until the end of the row.

The default settings at the start of a row are:

- Foreground colour white (CLUT address 7)
- Background colour black (CLUT address 8)
- Horizontal size ×1, vertical size ×1 (normal size)
- Alphanumeric on
- Contiguous mosaic graphics
- Release mosaics
- Flash off
- Box off
- Conceal off
- Twist off.

The attributes have individual codes which are defined in the basic character table (see Fig.22).

TV microcontrollers with Closed Captioning (CC) and On-Screen Display (OSD)

SAA55xx

Table 16 Serial character coding

BIT	DESCRIPTION		
	SERIAL MODE 0 (SET AT)	SERIAL MODE 1	
		CHAR.POS. 1 (SET AT)	CHAR.POS. >1 (SET AFTER)
0 to 3	4 bits for 16 background colours	4 bits for 16 background colours	4 bits for 16 background colours
4	Underline switch: 0 = underline off 1 = underline on	Horizontal size: 0 = normal 1 = ×2	Underline switch: 0 = underline off 1 = underline on
5	Overline switch: 0 = overline off 1 = overline on	Vertical size: 0 = normal 1 = ×2	Overline switch: 0 = overline off 1 = overline on
6	Display mode: 0 = superimpose 1 = boxing	Display mode: 0 = superimpose 1 = boxing	Display mode: 0 = superimpose 1 = boxing
7	Flash switch: 0 = flash off 1 = flash on	Foreground colour switch: 0 = Bank 0 (colours 0 to 7) 1 = Bank 1 (colours 8 to 15)	Foreground colour switch: 0 = Bank 0 (colours 0 to 7) 1 = Bank 1 (colours 8 to 15)
8	Italics switch 0 = italics off 1 = italics on	Background colour duration: 0 = stop BGC 1 = set BGC to end of row	Background colour duration (set at): 0 = stop BGC 1 = set BGC to end of row
9	Fringing switch: 0 = fringing off 1 = fringing on	End of row: 0 = continue row 1 = end row	End of row (set at): 0 = continue row 1 = end row
10	Switch for serial coding: 0 = mode 0 1 = mode 1	Switch for serial coding: 0 = mode 0 1 = mode 1	Switch for serial coding 0 = mode 0 1 = mode 1
11	Mode bit: 1 = serial code	Mode bit: 1 = serial code	Mode bit: 1 = serial code

TV microcontrollers with Closed Captioning (CC) and On-Screen Display (OSD)

SAA55xx

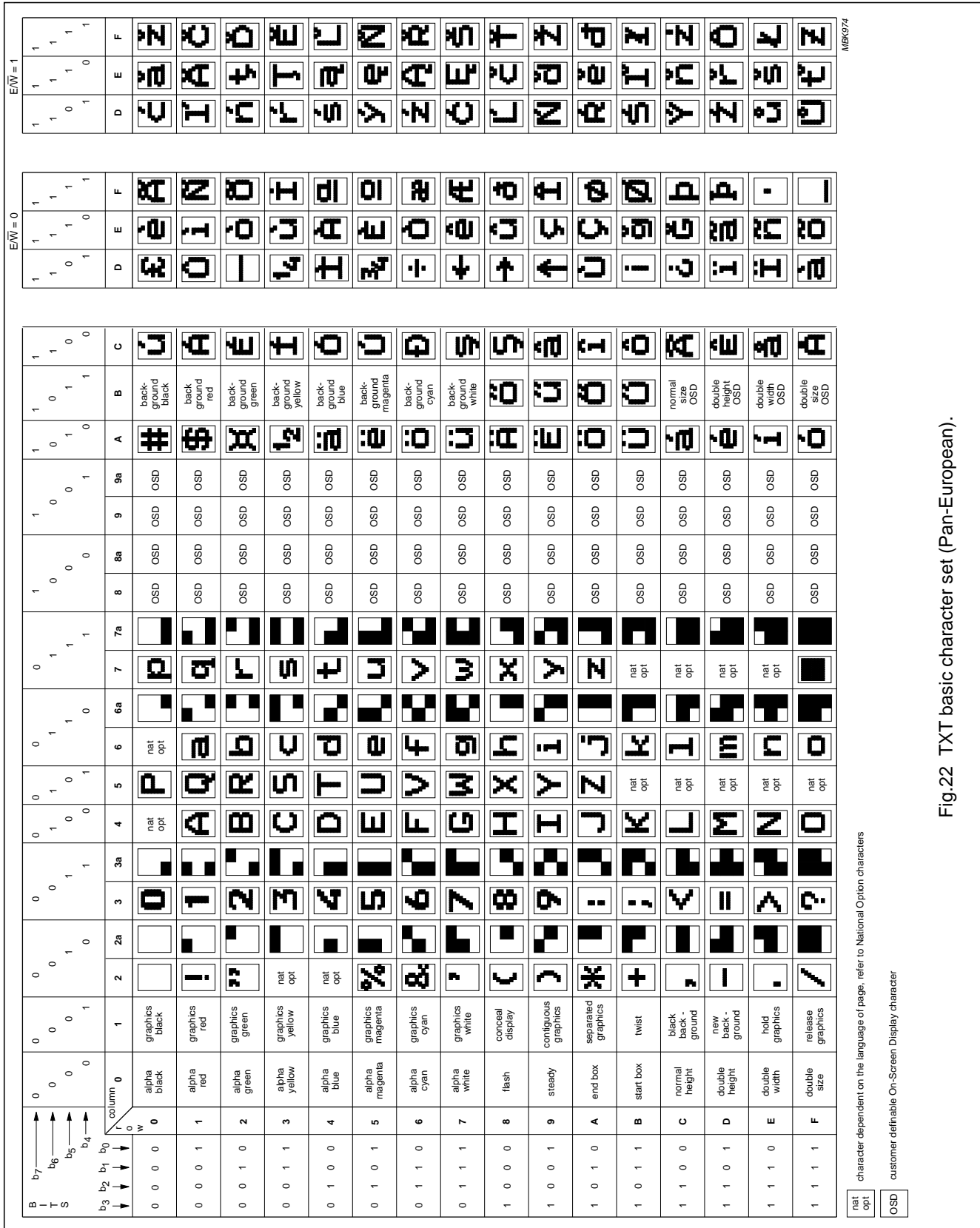

Fig.22 TXT basic character set (Pan-European).

TV microcontrollers with Closed Captioning (CC) and On-Screen Display (OSD)

SAA55xx

18.5 Screen and global controls

A number of attributes are available that affect the whole display region, and cannot be applied selectively to regions of the display.

18.5.1 TV SCAN LINES PER ROW

The number of TV scan lines per field used for each display row can be defined, the value is independent of the character size being used. The number of lines can be either 10, 13 or 16 per display row. The number of TV scan lines per row is defined `TXT21.DISPLAY LINES<1:0>`.

A value of 9 lines per row can be achieved if the display is forced into 525-line display mode by `TXT17.FORCE DISP<1:0>`, or if the device is in 10 line mode and the automatic detection circuitry within display finds 525-line display syncs.

18.5.2 CHARACTER MATRIX (H x V)

There are three different character matrices available, these are 12 x 10, 12 x 13 and 12 x 16. The selection is made using `TXT21.CHAR SIZE<1:0>` and is independent of the number of display lines per row.

If the character matrix is less than the number of TV scan lines per row then the matrix is padded with blank lines. If the character matrix is greater than the number of TV scan lines then the character is truncated.

18.5.3 DISPLAY MODES

CC: When attributes superimpose or boxing (see Table 16, Serial Mode 0/1, bit 6) are set, the resulting display depends on the setting of the following screen control mode bits in the MMR Display Control.

TXT: The display mode is controlled by the bits in the `TXT5` and `TXT6` registers. There are three control functions - Text on, Background on and Picture on. Separate sets of bits are used inside and outside teletext boxes so that different display modes can be invoked. `TXT6` is used if the newsflash (C5) or subtitle (C6) bits in row 25 of the basic page memory are set otherwise `TXT5` is used. This allows the software to set up the type of display required on newsflash and subtitle pages (e.g. text inside boxes, TV picture outside) this will be invoked without any further software intervention when such a page is acquired.

When teletext box control characters are present in the display page memory, the appropriate box control bit must be set, `TXT7.BOX ON 0`, `TXT7.BOX ON 1 – 23` or `TXT7.BOX ON 24`. This allows the display mode to be different inside the teletext box compared to outside. These bits are present to allow boxes in certain areas of the screen to be disabled. The use of teletext boxes for OSD messages has been superseded in this device by the OSD box concept, but these bits remain to allow teletext boxes to be used, if required.

Table 17 Display modes

MOD 0	MOD 1	DISPLAY MODE	DESCRIPTION
0	0	Video	Disables all display activities, sets the RGB to true black and VDS to video.
1	0	Full Text	Displays screen colour at all locations not covered by character foreground or background colour. The box attribute has no effect.
0	1	Mixed Screen Colour	Displays screen colour at all locations not covered by character foreground, within boxed areas or, background colour.
1	1	Mixed Video	Mixed Video mode displays video at all locations not covered by character foreground, within boxed areas or, background colour.

Table 18 TXT display control bits

PICTURE ON	TEXT ON	BACKGROUND ON	EFFECT
0	0	X	Text mode, black screen
0	1	0	Text mode, background always black
0	1	1	Text mode
1	0	X	Video mode
1	1	0	Mixed text and TV mode
1	1	1	Text mode, TV picture outside text area

18.5.4 SCREEN COLOUR

TV microcontrollers with Closed Captioning (CC) and On-Screen Display (OSD)

SAA55xx

Screen colour is displayed from 10.5 ms to 62.5 ms after the active edge of the HSYNC input and on TV lines 23 to 310 inclusive, for a 625-line display, and lines 17 to 260 inclusive for a 525-line display.

CC: The screen colour is defined by the MMR Display Control and points to a location in the CLUT table. The screen colour covers the full video width. It is visible when the Full Text or Mixed Screen Colour mode is set and no foreground or background pixels are being displayed.

TXT: The register bits TXT17.SCREEN COL<2:0> can be used to define a colour to be displayed in place of TV picture and the black background colour. If the bits are all set to zero, the screen colour is defined as 'transparent' and TV picture and background colour are displayed as normal. Otherwise the bits define CLUT entries 9 to 15.

18.6 Text display controls

18.6.1 TEXT DISPLAY CONFIGURATION (CC MODE)

Two types of areas are possible. The one area is static and the other is dynamic. The dynamic area allows scrolling of a region to take place. The areas cannot cross each other. Only one scroll region is possible.

18.6.2 DISPLAY MAP

The display map allows a flexible allocation of data in the memory to individual rows.

Sixteen words are provided in the display memory for this purpose. The lower 10 bits address the first word in the memory where the row data starts. This value is an offset in terms of 16-bit words from the start of Display memory (8000H). The most significant bit enables the display when not within the scroll (dynamic) area.

The display map memory is fixed at the first 16 words in the Closed Caption display memory.

Table 19 Display map bit allocation

BIT	FUNCTION
11	Text display enable, valid outside soft scroll area. 0 = disable; 1 = enable.
10	This bit is reserved, should be set to logic 0.
9 to 0	Pointer to row data.

TV microcontrollers with Closed Captioning (CC)
and On-Screen Display (OSD)

SAA55xx

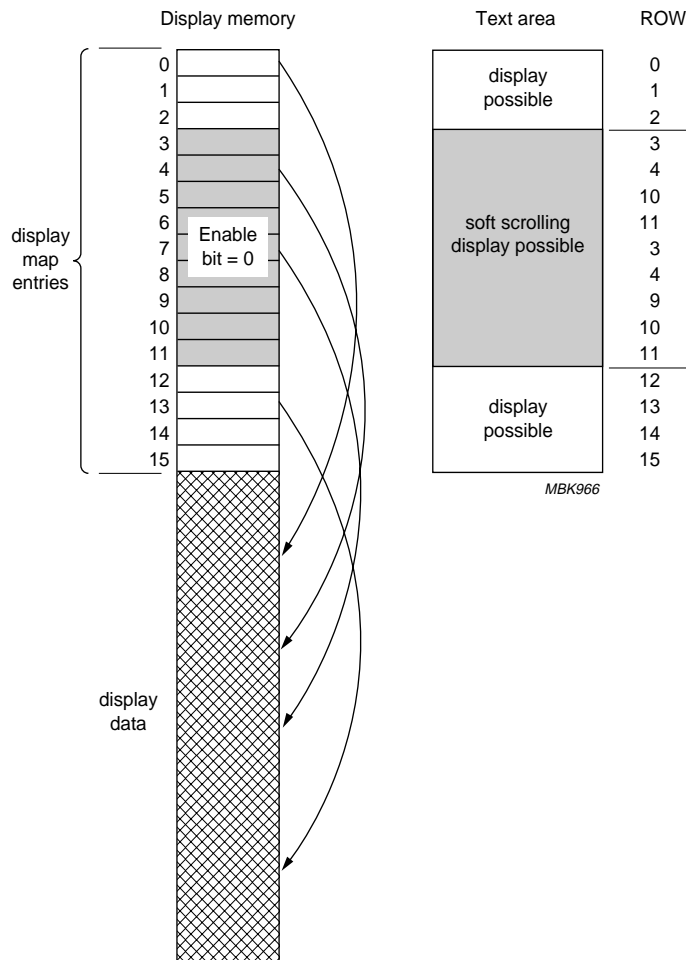

Fig.23 Display map and data pointers.

TV microcontrollers with Closed Captioning (CC) and On-Screen Display (OSD)

SAA55xx

18.6.3 SOFT SCROLL ACTION

The dynamic scroll region is defined by the MMR Scroll Area, MMR Scroll Range, MMR Top Scroll line and the MMR Status. The scroll area is enabled when the SCON bit is set in MMR Status.

The position of the soft scroll area window is defined using the Soft Scroll Position (SSP<3:0>), and the height of the window is defined using the Soft Scroll Height (SSH<3:0>) both are in MMR Scroll Range. The rows that are scrolled through the window are defined using the Start Scroll Row (STS<3:0>) and the Stop Scroll Row (SPS<3:0>) both are in MMR Scroll Area.

The soft scrolling function is done by modifying the Scroll Line (SCL<3:0>) in MMR Top Scroll Line. and the first scroll row value SCR<3:0> in the MMR Status.

If the number of rows allocated to the scroll counter is larger than the defined visible scroll area, this allows parts of rows at the top and bottom to be displayed during the scroll function. The registers can be written throughout the field and the values are updated for display with the next field sync. Care should be taken that the register pairs are written to by the software in the same field.

Only a region that contains only single height rows or only double height rows can be scrolled.

TXT: The display is organised as a fixed size of 25 rows (0 to 24) of 40 columns (0 to 39), This is the standard size for teletext transmissions. The control data in row 25 is not displayed but is used to configure the display page correctly.

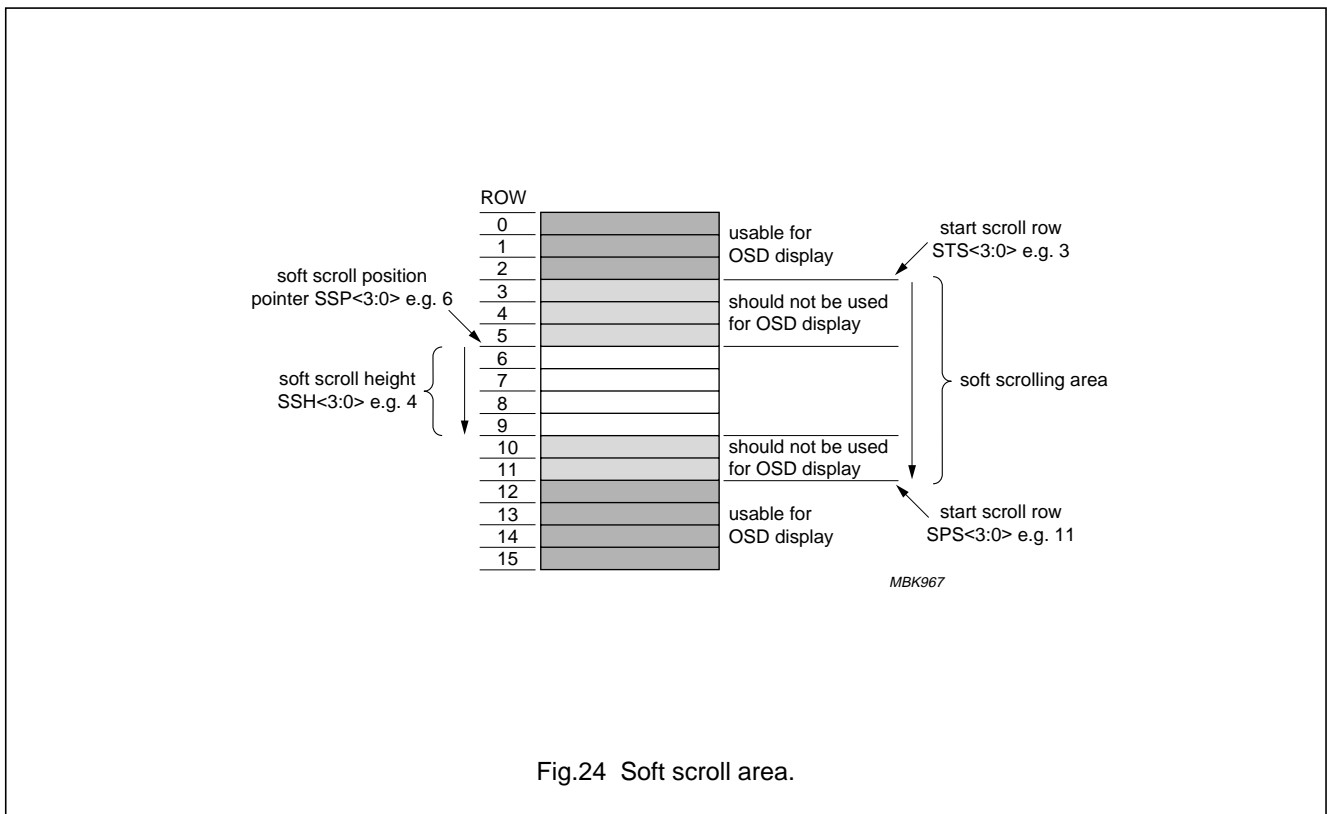

Fig.24 Soft scroll area.

TV microcontrollers with Closed Captioning (CC) and On-Screen Display (OSD)

SAA55xx

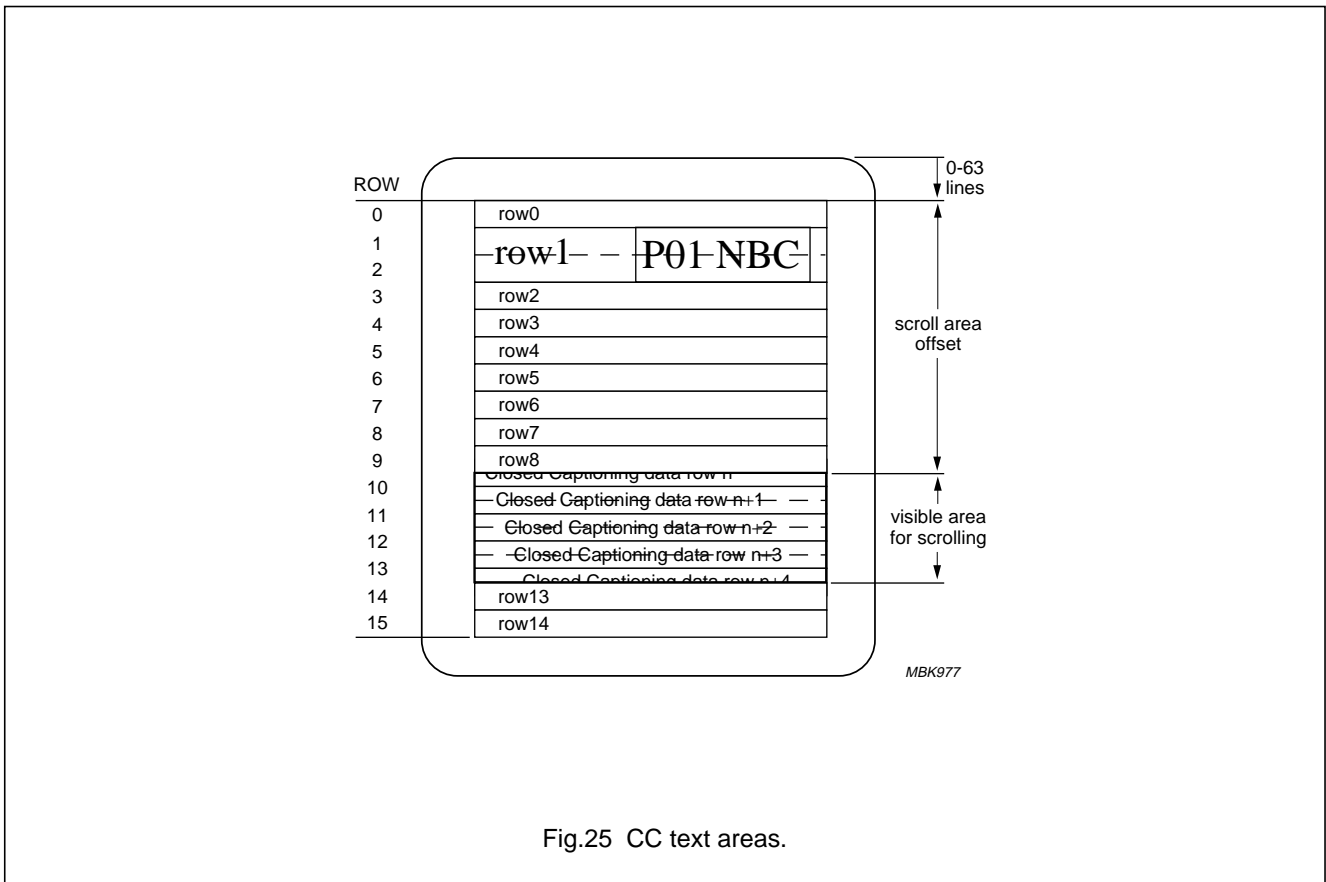

Fig.25 CC text areas.

TV microcontrollers with Closed Captioning (CC) and On-Screen Display (OSD)

SAA55xx

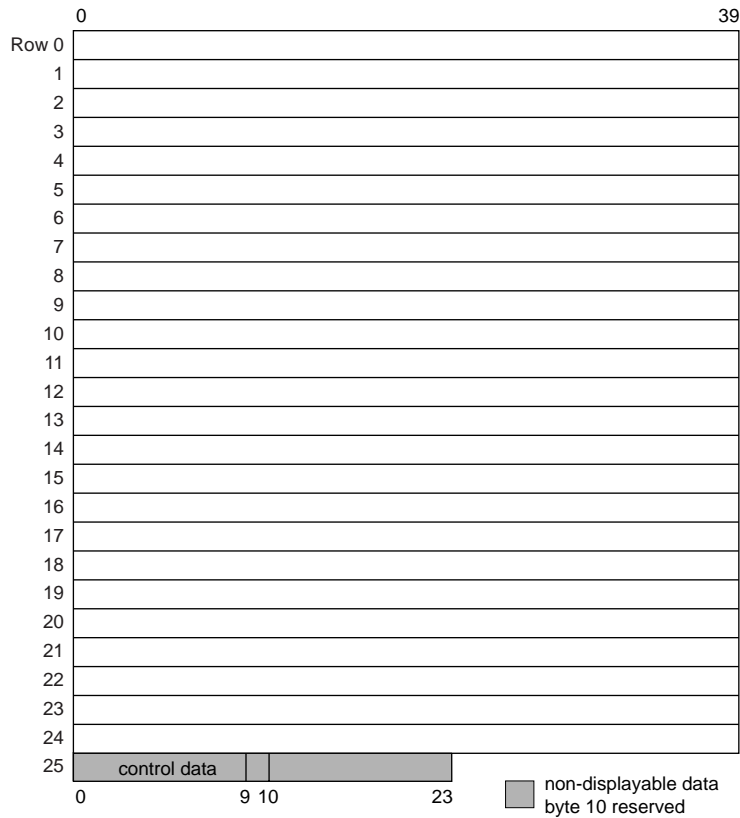

Fig.26 TXT text area.

TV microcontrollers with Closed Captioning (CC) and On-Screen Display (OSD)

SAA55xx

18.7 Display positioning

The display consists of the **screen colour** covering the whole screen and the **text area** that is placed within the visible screen area.

The screen colour extends over a large vertical and horizontal range so that no offset is needed. The text area is offset in both directions relative to the vertical and horizontal sync pulses.

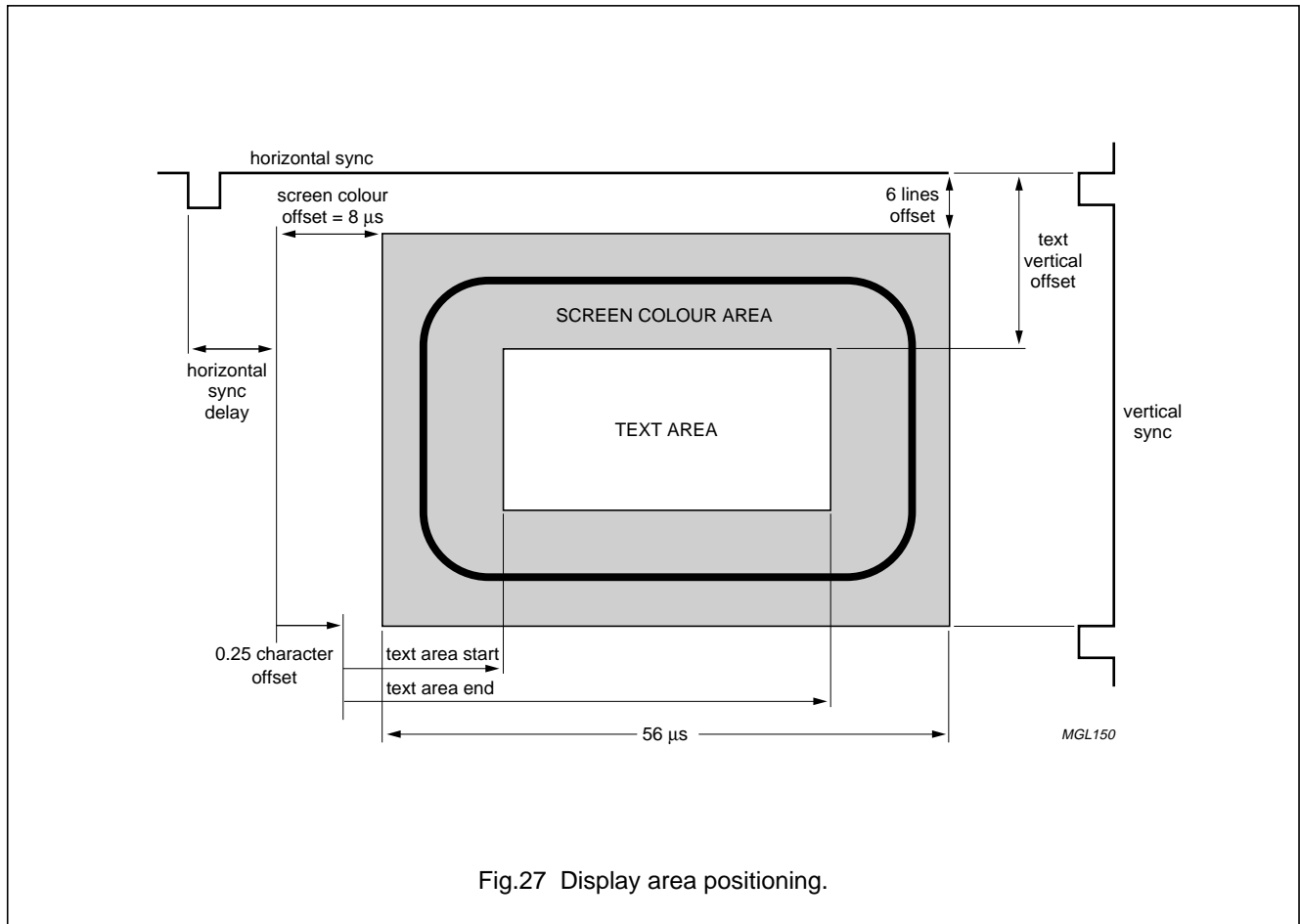

TV microcontrollers with Closed Captioning (CC) and On-Screen Display (OSD)

SAA55xx

18.7.1 SCREEN COLOUR DISPLAY AREA

This area is covered by the screen colour. The screen colour display area starts with a fixed offset of 8 μ s from the leading edge of the horizontal sync pulse in the horizontal direction. A vertical offset is not necessary.

Table 20 Screen colour display area

POSITION	525-LINE
Horizontal	Start at 8 μ s after leading edge of horizontal sync for 56 μ s.
Vertical	Line 9, Field 1 (321, Field 2) to leading edge of vertical sync (line numbering using 625 standard).

18.7.2 TEXT DISPLAY AREA

The text area can be defined to start with an offset in both the horizontal and vertical direction.

Table 21 Text display area

POSITION	DESCRIPTION
Horizontal	Up to 48 full sized characters per row. Start position setting from 8 to 64 characters from the leading edge of horizontal sync. Fine adjustment in quarter characters.
Vertical	256 lines (nominal 41 to 297). Start position setting from leading edge of vertical sync, legal values are 4 to 64 lines (line numbering using 625 standard).

The horizontal offset is set in the MMR Text Area Start. The offset is done in full width characters using TAS<5:0> and quarter characters using HOP<1:0> for fine setting. The values 00H to 08H for TAS<5:0> will result in a corrupted display.

The value 09H should also be avoided in the MMR Text Area Start as corruption of the row 24 display can occur. Alternative values are C8H or 49H to overcome this problem.

The width of the text area is defined in the MMR Text Area End Register by setting the end character value TAE<5:0>. This number determines where the background colour of the Text Area will end if set to extend to the end of the row. It will also terminate the character fetch process thus eliminating the necessity of a **row end** attribute. This entails however writing to all positions.

The vertical offset is set in the MMR Text Position Vertical. The offset value VOL<5:0> is done in number of TV scan lines.

Note that the Text Position Vertical Register should not be set to 00H as the Display Busy interrupt is not generated in these circumstances.

18.8 Character set

To facilitate the global nature of the device the character set has the ability to accommodate a large number of characters, which can be stored in different matrices.

18.8.1 CHARACTER MATRICES

The character matrices that can be accommodated in both display modes are:

(H \times V \times planes) 12 \times 9 \times 1, 12 \times 10 \times 1, 12 \times 13 \times 1, 12 \times 16 \times 1.

These modes allow two colours per character position.

In CC mode two additional character matrices are available to allow four colours per character.

(H \times V \times planes) 12 \times 13 \times 2, 12 \times 16 \times 2.

The characters are stored physically in ROM in a matrix of size either 12 \times 10 or 12 \times 16.

TV microcontrollers with Closed Captioning (CC) and On-Screen Display (OSD)

SAA55xx

18.8.2 CHARACTER SET SELECTION

Four character sets are available in the device. A set can consist of alphanumeric characters as required by the WST or US Closed Captioning, Customer definable On-Screen Display characters, and Special Graphic characters.

CC: Only a single character set can be used for display and this is selected using the Basic Set selection TXT18.BS<1:0>. When selecting a character set in CC mode, the Twist Set selection TXT19.TS<1:0> should be set to the same value as TXT18.BS<1:0> for correct operation.

TXT: Two character sets can be displayed at once. These are the basic G0 set or the alternative G0 set (Twist Set). The basic set is selected using TXT18.BS<1:0>.

The alternative/twist character set is defined by TXT19.TS<1:0>. Since the alternative character set is an option it can be enabled or disabled using TXT19.TEN, and the language code that is defined for the alternative set is defined by TXT19.TC<2:0>.

The National option table is selected using TXT18.NOT<3:0>. A maximum of 31 National option tables can be defined when combined with the EAST/WEST control bit located in register TXT4.

An example of the character set selection and definitions is show in Table 22.

An example of the National option reference table is shown in Table 23. Only a certain number of national options will be relevant for each of the Character sets.

Table 22 Character set selection

BS1/TS1	BS0/TS0	CHARACTER SET	EXAMPLE LANGUAGE
0	0	Set 0	Latin
0	1	Set 1	Greek
1	0	Set 2	–
1	1	Set 3	Closed Caption

Table 23 National option selection

C12	C13	C14	NOT<3:0> = 0000	NOT<3:0> = 0001	NOT<3:0> = 0010	...	NOT<3:0> = 1110
0	0	0	English	Polish	English	...	Polish
0	0	1	German	German	German	...	German
0	1	0	Swedish	Swedish	Swedish	...	Estonian
0	1	1	Italian	Italian	Italian	...	Lettish
1	0	0	French	French	French	...	Russian
1	0	1	Spanish	–	Spanish	...	Serb-Croat
1	1	0	Czech	Czech	Turkish	...	Czech
1	1	1	–	–	–	...	–

TV microcontrollers with Closed Captioning (CC) and On-Screen Display (OSD)

SAA55xx

18.9 ROM addressing

Three ROMs are used to generate the correct pixel information. The first contains the National option look-up table, the second contains the Basic character look-up table and the third contains the Character pixel information.

Although these are individual ROMs, since they do not need to be accessed simultaneously they are all combined into a single ROM unit.

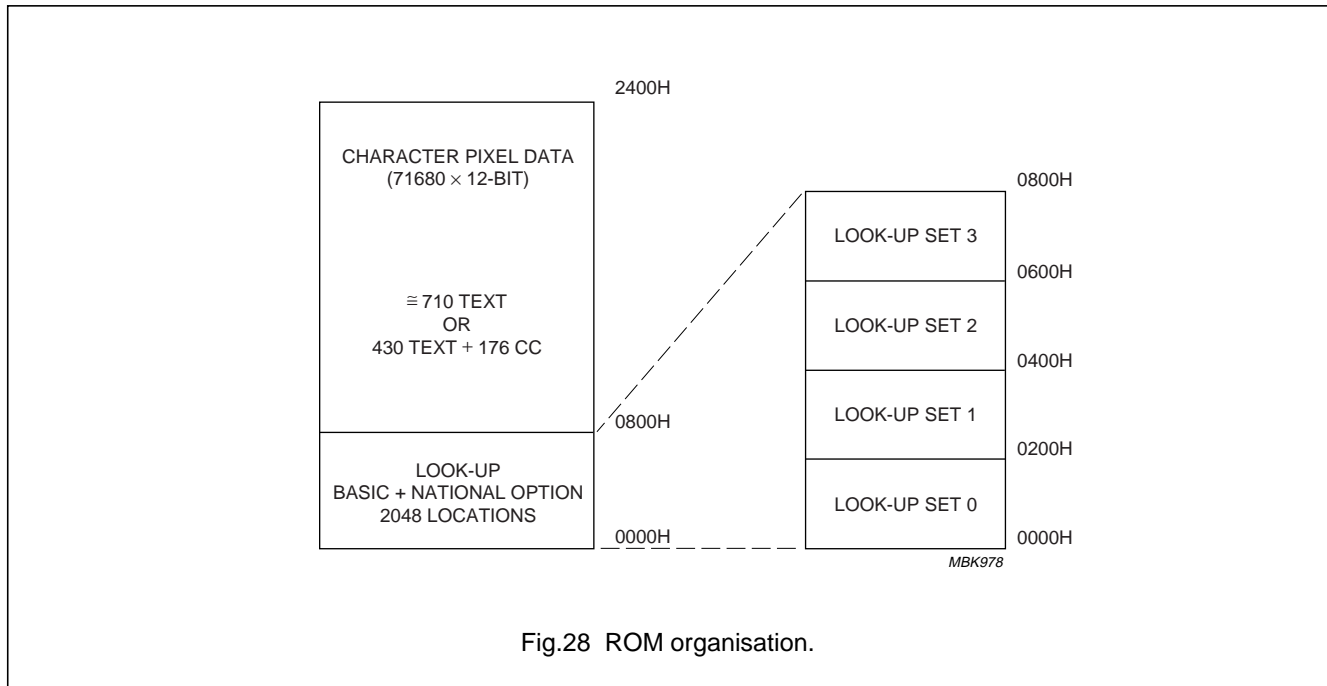

Fig.28 ROM organisation.

TV microcontrollers with Closed Captioning (CC) and On-Screen Display (OSD)

SAA55xx

18.9.1 CHARACTER TABLE

CC: The character table is shown in Fig.29.

TXT: One of the character set options (Pan-European: Latin) is shown in Fig.22.

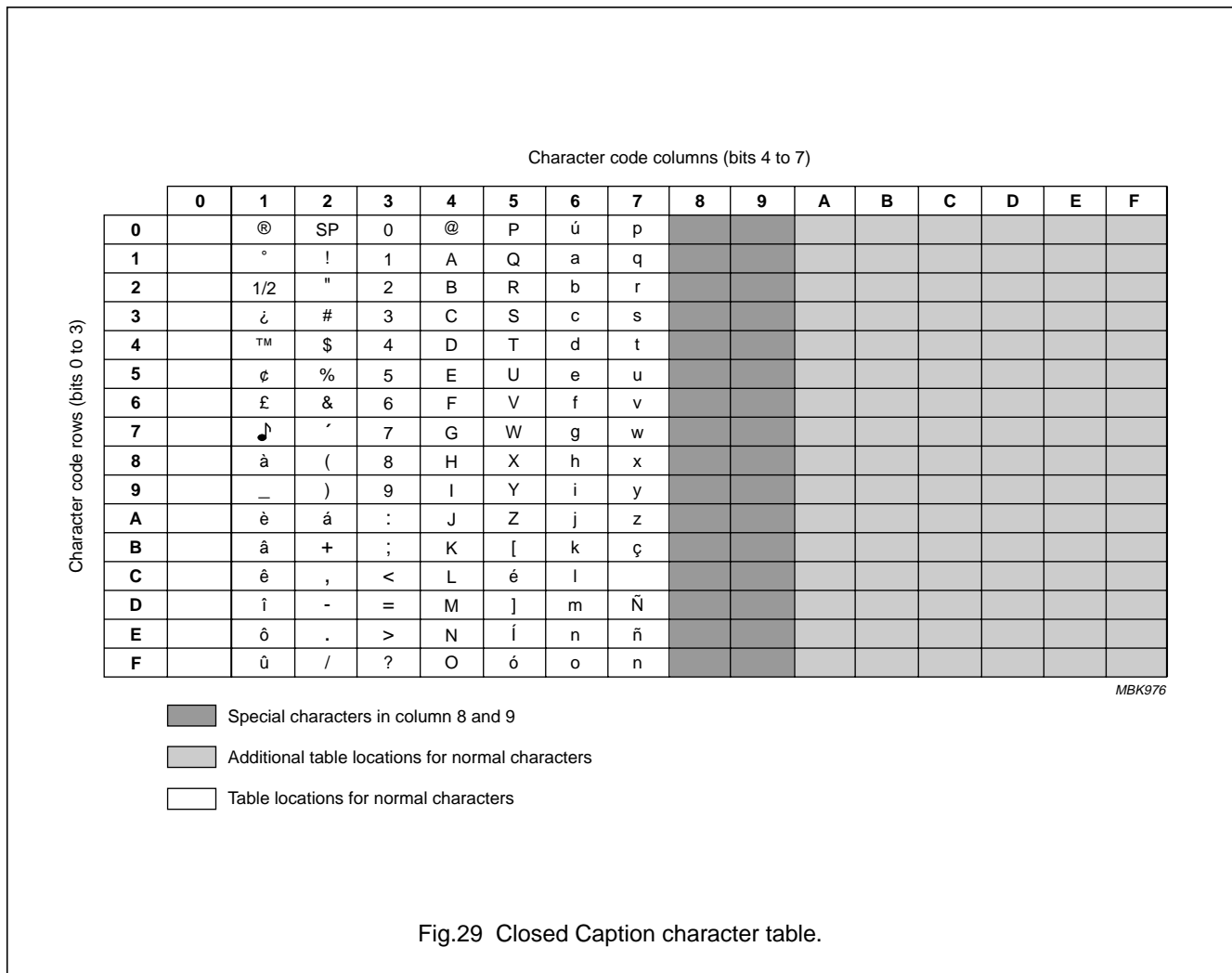

TV microcontrollers with Closed Captioning (CC) and On-Screen Display (OSD)

SAA55xx

18.10 Redefinable characters

A number of Dynamically Redefinable Characters (DRCs) are available. These are mapped onto the normal character codes, and replace the predefined ROM value.

There are 32 DRCs, the first 16 occupy the character codes 80H to 8FH, the second 16 occupy the locations 90H to 9FH. This allows for 32 DRCs or 16 Special DRCs.

The remapping of the standard OSD to the DRCs is activated when the TXT20.DRCS ENABLE bit is set. The selection of Normal or Special OSD symbols is defined by the TXT20.OSD PLANES.

Each character is stored in a matrix of $12 \times 16 \times 1$ (V \times H \times planes), this allows for all possible character matrices to be defined within a single location.

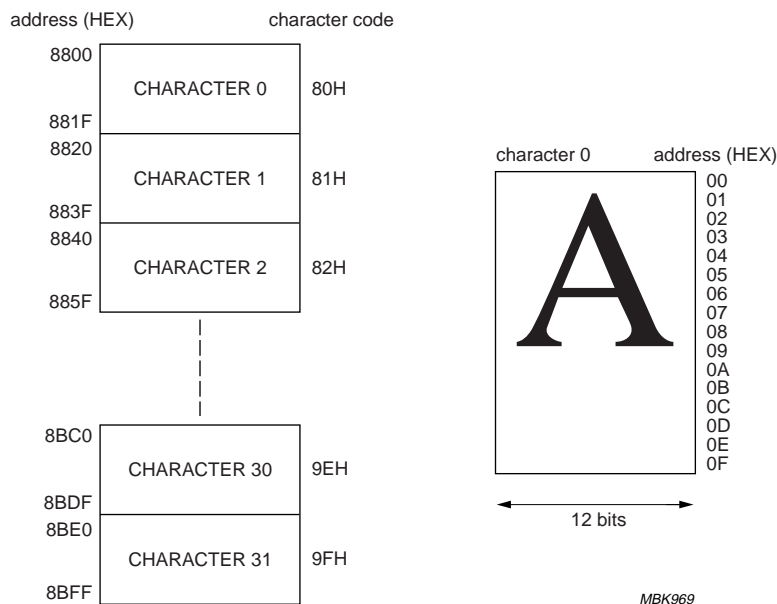

Fig.30 Organisation of DRC RAM.

TV microcontrollers with Closed Captioning (CC) and On-Screen Display (OSD)

SAA55xx

18.11 Display synchronization

The horizontal and vertical synchronizing signals from the TV deflection are used as inputs. Both signals can be inverted before being delivered to the Phase Selector section.

CC: The polarity is controlled using either VPOL or HPOL bits in the MMR Text Position Vertical.

TXT: The TXT1.H POLARITY and TXT1.V POLARITY bits control the polarity.

A line locked 12 MHz clock is derived from the 12 MHz free running oscillator by the Phase Selector. This line locked clock is used to clock the whole of the Display block.

The horizontal and vertical sync signals are synchronized with the 12 MHz clock before being used in the display section.

18.12 Video/Data switch (Fast Blanking) polarity

The polarity of the video/data (Fast Blanking) signal can be inverted. The polarity is set with the VDSPOL bit in the MMR RGB Brightness.

Table 24 Fast blanking signal polarity

VDSPOL	VDS	CONDITION
0	1	RGB display
0	0	Video display
1	0	RGB display
1	1	Video display

18.13 Video/data switch adjustment

To take into account the delay between the RGB values and the VDS signal due to external buffering, the VDS signal can be moved in relation to the RGB signals. The VDS signal can be set to be either a clock cycle before or after the RGB signal, or coincident with the RGB signal. This is done using VDEL<2:0> in the MMR Configuration.

18.14 RGB brightness control

A brightness control is provided to allow the RGB upper output voltage level to be modified. The nominal value is 1 V into a 150 Ω resistor, but can be varied between 0.7 V and 1.2 V.

The brightness is set in MMR RGB Brightness.

Table 25 RGB brightness

BRI3 TO BRI0	RGB BRIGHTNESS
0000	lowest value
...	...
1111	highest value

18.15 Contrast reduction

CC: This feature is not available in CC mode.

TXT: The \overline{COR} bits in SFRs TXT5 and TXT6 control when the \overline{COR} output of the device is activated (i.e. pulled LOW). This output is intended to act on the TV's display circuits to reduce contrast of the video when it is active. The result of contrast reduction is to improve the readability of the text in a mixed teletext and video display.

The bits in the TXT5 and TXT6 SFRs allow the display to be set up so that, for example, the areas inside teletext boxes will be contrast reduced when a subtitle is being displayed but that the rest of the screen will be displayed as normal video.

19 MEMORY MAPPED REGISTERS (MMR)

The memory mapped registers are used to control the display. The registers are mapped into the microcontroller MOVX address space, starting at address 87F0H and extending to 87FFH.

Table 26 MMR address summary

REGISTER NUMBER	MEMORY ADDRESS	FUNCTION
0	87F0H	Display Control
1	87F1H	Text Position Vertical
2	87F2H	Text Area Start
3	87F3H	Fringing Control
4	87F4H	Text Area End
5	87F5H	Scroll Area
6	87F6H	Scroll Range
7	87F7H	RGB Brightness
8	87F8H	Status
9	87F9H	reserved
10	87FAH	reserved
11	87FBH	reserved
12	87FCH	HSYNC Delay
13	87FDH	VSYNC Sync Delay
14	87FEH	Top Scroll Line
15	87FFH	Configuration

TV microcontrollers with Closed Captioning (CC) and On-Screen Display (OSD)

SAA55xx

Table 27 MMR map

ADD	R/W	NAME	7	6	5	4	3	2	1	0	RESET
87F0	R/W	Display Control	SRC3	SRC2	SRC1	SRC0	–	MSH	MOD1	MOD0	00H
87F1	R/W	Text Position Vertical	VPOL	HPOL	VOL5	VOL4	VOL3	VOL2	VOL1	VOL0	00H
87F2	R/W	Text Area Start	HOP1	HOP0	TAS5	TAS4	TAS3	TAS2	TAS1	TAS0	00H
87F3	R/W	Fringing Control	FRC3	FRC2	FRC1	FRC0	FRDN	FRDE	FRDS	FRDW	00H
87F4	R/W	Text Area End	–	–	TAE5	TAE4	TAE3	TAE2	TAE1	TAE0	00H
87F5	R/W	Scroll Area	SSH3	SSH2	SSH1	SSH0	SSP3	SSP2	SSP1	SSP0	00H
87F6	R/W	Scroll Range	SPS3	SPS2	SPS1	SPS0	STS3	STS2	STS1	STS0	00H
87F7	R/W	RGB Brightness	VDSPOL	–	–	–	BRI3	BRI2	BRI1	BRI0	00H
87F8	R	Status	BUSY	FIELD	SCON	FLR	SCR3	SCR2	SCR1	SCR0	00H
	W		–	–	SCON	FLR	SCR3	SCR2	SCR1	SCR0	00H
87FC	R/W	HSYNC Delay	–	HSD6	HSD5	HSD4	HSD3	HSD2	HSD1	HSD0	00H
87FD	R/W	VSYNC Delay	–	VSD6	VSD5	VSD4	VSD3	VSD2	VSD1	VSD0	00H
87FE	R/W	Top Scroll Line	–	–	–	–	SCL3	SCL2	SCL1	SCL0	00H
87FF	R/W	Configuration	CC	VDEL2	VDEL1	VDEL0	TXT/V	–	–	–	00H

TV microcontrollers with Closed Captioning (CC) and On-Screen Display (OSD)

SAA55xx

Table 28 MMR bit definition

REGISTER BIT	FUNCTION
Display Control	
SRC3 to SRC0	screen colour definition
MSH	meshing all background colours (logic 1)
MOD1 to MOD0	00 = Video 01 = Full Text 10 = Mixed Screen Colour 11 = Mixed Video
Text Position Vertical	
VPOL	inverted input polarity (logic 1)
HPOL	inverted input polarity (logic 1)
VOL5 to VOL0	display start vertical offset from VSYNC (lines)
Text Area Start	
HOP1 to HOP0	fine horizontal offset in quarter of characters
TAS5 to TAS0	text area start
Fringing Control	
FRC3 to FRC0	fringing colour, value address of CLUT
FRDN	fringe in north direction (logic 1)
FRDE	fringe in east direction (logic 1)
FRDS	fringe in south direction (logic 1)
FRDW	fringe in west direction (logic 1)
Text Area End	
TAE5 to TAE0	text area end, in full characters
Scroll Area	
SSH3 to SSH0	soft scroll height
SSP3 to SSP0	soft scroll position
Scroll Range	
SPS3 to SPS0	stop scroll row
STS3 to STS0	start scroll row
RGB Brightness	
VDSPOL	VDS polarity 0 = RGB (1), Video (0) 1 = RGB (0), Video (1)
BRI3 to BRI0	RGB brightness control

TV microcontrollers with Closed Captioning (CC) and On-Screen Display (OSD)

SAA55xx

REGISTER BIT	FUNCTION
Status read	
BUSY	access to display memory could cause display problems (logic 1)
FIELD	even field (logic 1)
FLR	active flash region background only displayed (logic 1)
SCR3 to SCR0	first scroll row
Status write	
SCON	scroll area enabled (logic 1)
FLR	active flash region background colour only displayed (logic 1)
SCR3 to SCR0	first scroll row
HSYNC Delay	
HSD6 to HSD0	HSYNC delay, in full size characters
VSYNC Delay	
VSD6 to VSD0	VSYNC delay in number of 8-bit 12 MHz clock cycles
Top Scroll Line	
SCL3 to SCL0	top line for scroll
Configuration	
CC	closed caption mode (logic 1)
VDEL2 to VDEL0	pixel delay between VDS and RGB output 000 = VDS switched to video, not active 001 = VDS active one pixel earlier then RGB 010 = VDS synchronous to RGB 100 = VDS active one pixel after RGB
TXT/V	BUSY signal switch; horizontal (logic 1)

TV microcontrollers with Closed Captioning (CC) and On-Screen Display (OSD)

SAA55xx

20 LIMITING VALUES

In accordance with Absolute Maximum Rating System (IEC 60134).

SYMBOL	PARAMETER	CONDITIONS	MIN.	MAX.	UNIT
V_{DDX}	supply voltage (all supplies)		-0.5	+4.0	V
V_I	input voltage (any input)	note 1	-0.5	$V_{DD} + 0.5$ or 4.1	V
V_O	output voltage (any output)	note 1	-0.5	$V_{DD} + 0.5$	V
I_O	output current (each output)		-	± 10	mA
$I_{I/OK}$	DC input or output diode current		-	± 20	mA
T_{amb}	ambient temperature		-20	+70	°C
T_{stg}	storage temperature		-55	+125	°C

Note

1. This maximum value refers to 5 V tolerant I/Os and may be 6 V maximum, but only when V_{DD} is present.

21 CHARACTERISTICS

$V_{DD} = 3.3 \text{ V} \pm 10\%$; $V_{SS} = 0 \text{ V}$; $T_{amb} = -20$ to $+70 \text{ °C}$; unless otherwise specified.

SYMBOL	PARAMETER	CONDITIONS	MIN.	TYP.	MAX.	UNIT
Supplies						
V_{DDX}	any supply voltage (V_{DD} to V_{SS})		3.0	3.3	3.6	V
I_{DDP}	Periphery supply current	note 1	1	-	-	mA
I_{DDC}	core supply current		-	12	18	mA
$I_{DDC(id)}$	Idle mode core supply current		-	383	600	μA
$I_{DDC(pd)}$	Power-down mode core supply current		-	666	900	μA
$I_{DDC(stb)}$	Standby mode core supply current		-	5.1	9	mA
I_{DDA}	analog supply current		-	45	48	mA
$I_{DDA(id)}$	Idle mode analog supply current		-	444	700	μA
$I_{DDA(pd)}$	Power-down mode analog supply current		-	433	700	μA
$I_{DDA(stb)}$	Standby mode analog supply current		-	809	950	μA
Digital inputs						
RESET						
V_{IL}	LOW-level input voltage		-	-	1.00	V
V_{IH}	HIGH-level input voltage		1.85	-	-	V
V_{hys}	hysteresis voltage of Schmitt trigger input		0.44	-	0.58	V
I_{LI}	input leakage current	$V_I = 0$	-	-	0.17	μA
R_{pd}	equivalent pull-down resistance	$V_I = V_{DD}$	55.73	70.71	92.45	$\text{k}\Omega$

TV microcontrollers with Closed Captioning (CC) and On-Screen Display (OSD)

SAA55xx

SYMBOL	PARAMETER	CONDITIONS	MIN.	TYP.	MAX.	UNIT
HSYNC AND VSYNC						
V_{IL}	LOW-level input voltage		–	–	0.96	V
V_{IH}	HIGH-level input voltage		1.80	–	–	V
V_{hys}	hysteresis voltage of Schmitt trigger input		0.40	–	0.56	V
I_{LI}	input leakage current	$V_I = 0$ to V_{DD}	–	–	0.00	μ A
Digital outputs						
FRAME, VDS						
V_{OL}	LOW-level output voltage	$I_{OL} = 3$ mA	–	–	0.13	V
V_{OH}	HIGH-level output voltage	$I_{OH} = 3$ mA	2.84	–	–	V
t_r	output rise time	10% to 90%; $C_L = 70$ pF	7.50	8.85	10.90	ns
t_f	output fall time	10% to 90%; $C_L = 70$ pF	6.70	7.97	10.00	ns
\overline{COR} (OPEN-DRAIN OUTPUT)						
V_{OL}	LOW-level output voltage	$I_{OL} = 3$ mA	–	–	0.14	V
V_{OH}	HIGH-level pull-up output voltage	$I_{OL} = -3$ mA; push-pull	2.84	–	–	V
V_{IL}	LOW-level input voltage		–	–	0.00	V
V_{IH}	HIGH-level input voltage		0.00	–	5.50	V
I_{LI}	input leakage current	$V_I = 0$ to V_{DD}	–	–	0.12	μ A
t_r	output rise time	10% to 90%; $C_L = 70$ pF	7.20	8.64	11.10	ns
	output fall time	10% to 90%; $C_L = 70$ pF	4.90	7.34	9.40	ns
Digital input/outputs						
P0.0 TO P0.4, P0.7, P1.0 TO P1.1, P2.1 TO P2.7, P3.0 TO P3.7						
V_{IL}	LOW-level input voltage		–	–	0.98	V
V_{IH}	HIGH-level input voltage		1.78	–	–	V
V_{hys}	hysteresis voltage of Schmitt trigger input		0.41	–	0.55	V
I_{LI}	input leakage current	$V_I = 0$ to V_{DD}	–	–	0.01	μ A
V_{OL}	LOW-level output voltage	$I_{OL} = 4$ mA	–	–	0.18	V
V_{OH}	HIGH-level output voltage	$I_{OH} = -4$ mA push-pull	2.81	–	5.50	V
t_r	output rise time	10% to 90%; $C_L = 70$ pF push-pull	6.50	8.47	10.70	ns
t_f	output fall time	10% to 90%; $C_L = 70$ pF	5.70	7.56	10.00	ns

TV microcontrollers with Closed Captioning (CC) and On-Screen Display (OSD)

SAA55xx

SYMBOL	PARAMETER	CONDITIONS	MIN.	TYP.	MAX.	UNIT
P1.2, P1.3 AND P2.0						
V _{IL}	LOW-level input voltage		–	–	0.99	V
V _{IH}	HIGH-level input voltage		1.80	–	–	V
V _{hys}	hysteresis voltage of Schmitt trigger input		0.42	–	0.56	V
I _{LI}	input leakage current	V _I = 0 to V _{DD}	–	–	0.02	μA
V _{OL}	LOW-level output voltage	I _{OL} = 4 mA	–	–	0.17	V
V _{OH}	HIGH-level output voltage	I _{OH} = –4 mA push-pull	2.81	–	5.50	V
t _r	output rise time	10% to 90%; C _L = 70 pF push-pull	7.00	8.47	10.50	ns
t _f	output fall time	10% to 90%; C _L = 70 pF	5.40	7.36	9.30	ns
P0.5 AND P0.6						
V _{IL}	LOW-level input voltage		–	–	0.98	V
V _{IH}	HIGH-level input voltage		1.82	–	–	V
I _{LI}	input leakage current	V _I = 0 to V _{DD}	–	–	0.11	μA
V _{hys}	hysteresis of Schmitt trigger input		0.42	–	0.58	V
V _{OL}	LOW-level output voltage	I _{OL} = 8 mA	–	–	0.20	V
V _{OH}	HIGH-level output voltage	I _{OH} = –8 mA push-pull	2.76	–	5.50	V
t _r	output rise time	10% to 90%; C _L = 70 pF push-pull	7.40	8.22	8.80	ns
t _f	output fall time	10% to 90%; C _L = 70 pF	4.20	4.57	5.20	ns
P1.4 TO P1.7 (OPEN-DRAIN)						
V _{IL}	LOW-level input voltage		–	–	1.08	V
V _{IH}	HIGH-level input voltage		1.99	–	–	V
V _{hys}	hysteresis voltage of Schmitt trigger input		0.49	–	0.60	V
I _{LI}	input leakage current	V _I = 0 to V _{DD}	–	–	0.13	μA
V _{OL}	LOW-level output voltage	I _{OL} = 8 mA	–	–	0.35	V
t _f	output fall time	10% to 90%; C _L = 70 pF	69.70	83.67	103.30	ns
Analog inputs						
CVBS0 AND CVBS1						
V _{sync}	sync voltage amplitude		0.1	0.3	0.6	V
V _{vid(p-p)}	video input voltage amplitude (peak-to-peak value)		0.7	1.0	1.4	V
Z _{source}	source impedance		0	–	250	Ω

TV microcontrollers with Closed Captioning (CC) and On-Screen Display (OSD)

SAA55xx

SYMBOL	PARAMETER	CONDITIONS	MIN.	TYP.	MAX.	UNIT
V_{IH}	HIGH-level input voltage		3.0	–	$V_{DDA} + 0.3$	V
C_I	input capacitance		–	–	10	pF
IREF						
R_{gnd}	resistor to ground	resistor tolerance 2%	–	24	–	k Ω
ADC0 TO ADC3						
V_{IH}	HIGH-level input voltage		–	–	V_{DDA}	V
C_I	input capacitance		–	–	10	pF
VPE						
V_{IH}	HIGH-level input voltage		–	–	9.0	V
Analog outputs						
R, G AND B						
I_{OL}	output current (Black Level)	$V_{DDA} = 3.3$ V	–10	–	+10	μ A
I_{OH}	output current (maximum Intensity)	$V_{DDA} = 3.3$ V Intensity level code = 15 dec	6.0	6.67	7.3	mA
	output current (70% of full Intensity)	$V_{DDA} = 3.3$ V Intensity level code = 0 dec	4.2	4.7	5.1	mA
R_{load}	load resistor to V_{SSA}	resistor tolerance 5%	–	150	–	Ω
C_L	load capacitance		–	–	15	pF
Analog input/output						
SYNC_FILTER						
C_{sync}	storage capacitor to ground		–	100	–	nF
V_{sync}	sync filter level voltage for nominal sync amplitude		0.35	0.55	0.75	V
Crystal oscillator						
XTALIN						
V_{IL}	LOW-level input voltage		V_{SSA}	–	–	V
V_{IH}	HIGH-level input voltage		–	–	V_{DDA}	V
C_I	input capacitance		–	–	10	pF
XTALOUT						
C_O	output capacitance		–	–	10	pF

TV microcontrollers with Closed Captioning (CC) and On-Screen Display (OSD)

SAA55xx

SYMBOL	PARAMETER	CONDITIONS	MIN.	TYP.	MAX.	UNIT
Crystal specification; notes 2 and 3						
f_{xtal}	nominal frequency	fundamental mode	–	12	–	MHz
C_L	crystal load capacitance		–	–	30	pF
C_1	crystal motional capacitance	$T_{\text{amb}} = 25\text{ °C}$	–	–	20	fF
R_r	resonance resistance	$T_{\text{amb}} = 25\text{ °C}$	–	–	60	Ω
C_{osc}	capacitors at XTALIN, XTALOUT	$T_{\text{amb}} = 25\text{ °C}$	–	note 4	–	pF
C_0	crystal holder capacitance	$T_{\text{amb}} = 25\text{ °C}$	–	–	note 5	pF
T_{xtal}	temperature range		–20	+25	+85	$^{\circ}\text{C}$
X_j	adjustment tolerance	$T_{\text{amb}} = 25\text{ °C}$	–	–	$\pm 50 \times 10^{-6}$	
X_d	drift		–	–	$\pm 100 \times 10^{-6}$	

Notes

- Peripheral current is dependent on external components and voltage levels on I/Os.
- Crystal order number 4322 143 05561.
- If the 4322 143 05561 crystal is not used, then the formulae in the crystal specification should be used. Where $C_{\text{IO}} = 7\text{ pF}$, the mean of the capacitances due to the chip at XTALIN and at XTALOUT. C_{ext} is a value for the mean of the stray capacitances due to the external circuit at XTALIN and XTALOUT. The maximum value for the crystal holder capacitance is to ensure start-up – C_{osc} may need to be reduced from the initially selected value.
- $C_{\text{osc}(\text{typ})} = 2C_L - (C_{\text{IO}} - C_{\text{ext}})$
- $C_{0(\text{max})} = 35 - \frac{1}{2}(C_{\text{osc}} + C_{\text{IO}} + C_{\text{ext}})$

TV microcontrollers with Closed Captioning (CC) and On-Screen Display (OSD)

SAA55xx

Table 29 I²C-bus characteristics

SYMBOL	PARAMETER	FAST-MODE I ² C-bus		UNIT
		MIN.	MAX.	
f _{SCL}	SCL clock frequency	0	400	kHz
t _{BUF}	bus free time between a STOP and START condition	1.3	–	μs
t _{HD;STA}	hold time (repeated) START condition. After this period, the first clock pulse is generated.	0.6	–	μs
t _{LOW}	LOW period of the SCL clock	1.3	–	μs
t _{HIGH}	HIGH period of the SCL clock	0.6	–	μs
t _{SU;STA}	set up time for a repeated START condition	0.6	–	μs
t _{HD;DAT}	data hold time; notes 1 and 2	0	0.9	μs
t _{SU;DAT}	data set up time; note 3	100	–	ns
t _r	rise time of both SDA and SCL signals; note 4	20	300	ns
t _f	fall time of both SDA and SCL signals; note 4	20	300	ns
t _{SU;STO}	set up time for STOP condition	0.6	–	μs
C _b	capacitive load for each bus line	–	400	pF

Notes

1. A device must internally provide a hold time of at least 300 ns for the SDA signal (referred to the V_{IH(min)} of the SCL signal) in order to bridge the undefined region of the falling edge of SCL.
2. The maximum f_{HD;DAT} has only to be met if the device does not stretch the LOW period t_{LOW} of the SCL signal.
3. A fast-mode I²C-bus device can be used in a standard-mode I²C-bus system, but the requirement t_{SU;DAT} ≥ 250 ns must then be met. This will automatically be the case if the device does not stretch the LOW period of the SCL signal. If such a device does stretch the LOW period of the SCL signal, it must output the next data bit to the SDA line t_{rmax} + t_{SU;DAT} = 1000 + 250 = 1250 ns (according to the standard-mode I²C-bus specification) before the SCL line is released.
4. C_b = total capacitance of one bus line in pF.

TV microcontrollers with Closed Captioning (CC) and On-Screen Display (OSD)

SAA55xx

22 QUALITY AND RELIABILITY

This device will meet Philips Semiconductors General Quality Specification for Business group "Consumer Integrated Circuits SNW-FQ-611-Part E". The principal requirements are shown in Tables 30 to 33.

Table 30 Acceptance tests per lot

TEST	REQUIREMENTS
Mechanical	cumulative target: <80 ppm
Electrical	cumulative target: <100 ppm

Table 31 Processability tests (by package family)

TEST	REQUIREMENTS
Solderability	0/16 on all lots
Mechanical	0/15 on all lots
Solder heat resistance	0/15 on all lots

Table 32 Reliability tests (by process family)

TEST	CONDITIONS	REQUIREMENTS
Operational life	168 hours at $T_j = 150\text{ }^\circ\text{C}$	<1000 FPM at $T_j = 150\text{ }^\circ\text{C}$
Humidity life	temperature, humidity, bias 1000 hours, $85\text{ }^\circ\text{C}$, 85% RH (or equivalent test)	<2000 FPM
Temperature cycling performance	$T_{\text{stg}(\text{min})}$ to $T_{\text{stg}(\text{max})}$	<2000 FPM

Table 33 Reliability tests (by device type)

TEST	CONDITIONS	REQUIREMENTS
ESD and latch-up	ESD Human body model 100 pF, 1.5 kW	2000 V
	ESD Machine model 200 pF, 0 W	200 V
	latch-up	100 mA, $1.5 \times V_{\text{DD}}$ (absolute maximum)

Notes to Tables 30 to 33

1. ppm = fraction of defective devices, in parts per million.
2. FPM = fraction of devices failing at test condition, in Failures Per Million.
3. FITS = Failures In Time Standard.

TV microcontrollers with Closed Captioning (CC) and On-Screen Display (OSD)

SAA55xx

23 APPLICATION INFORMATION

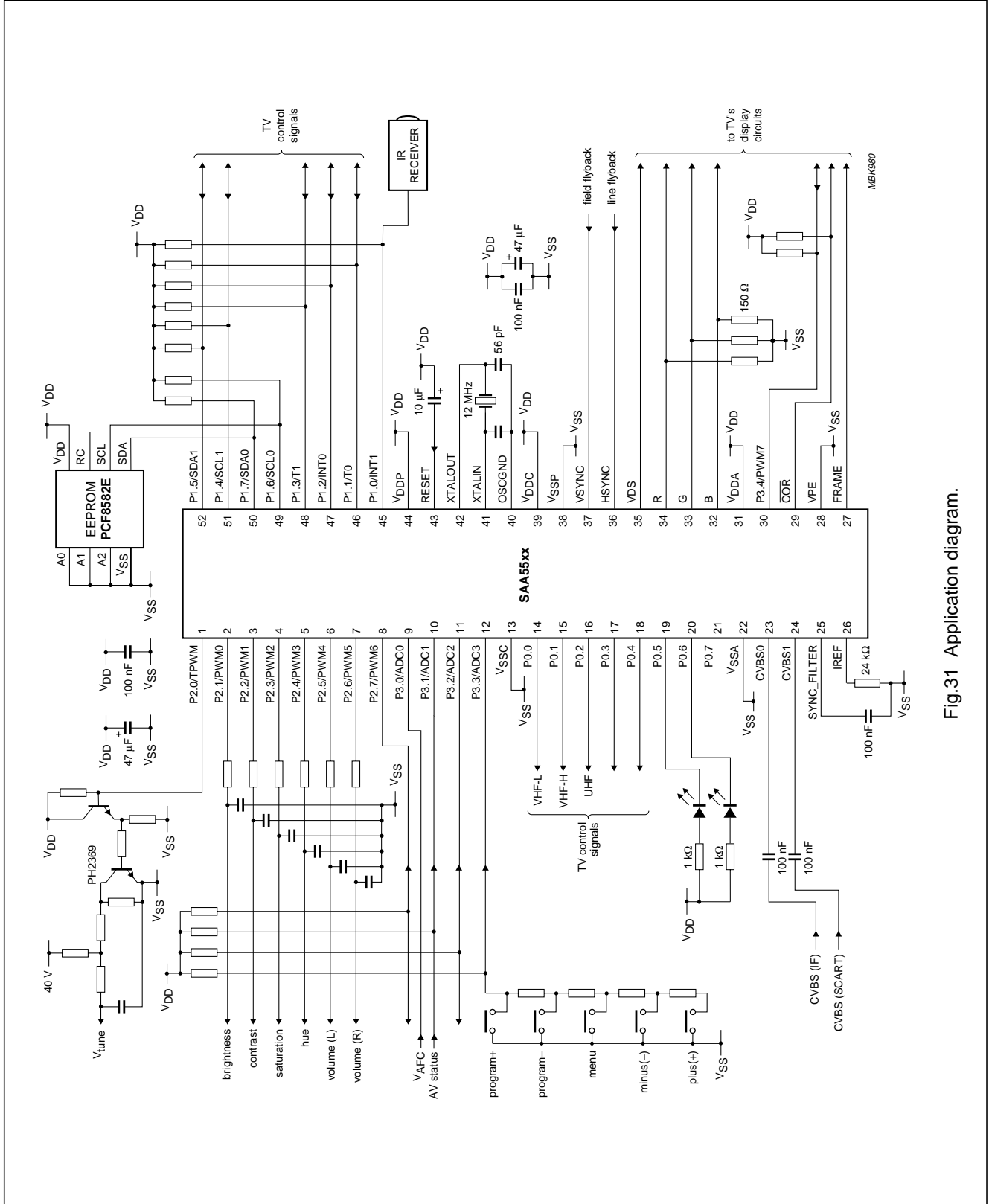

Fig.31 Application diagram.

TV microcontrollers with Closed Captioning (CC) and On-Screen Display (OSD)

SAA55xx

24 ELECTROMAGNETIC COMPATIBILITY (EMC) GUIDELINES

Optimization of circuit return paths and minimisation of common mode emission will be assisted by using a double sided printed-circuit board (PCB) with low inductance ground plane.

On a single-sided PCB a local ground plane under the whole Integrated Circuit (IC) should be present as shown in Fig.32. This should be connected by the widest possible connection back to the PCB ground connection, and bulk electrolytic decoupling capacitor. It should preferably not connect to other grounds on the way, and no wire links should be present in this connect. The use of wire links increases ground bounce by introducing inductance into the ground.

The supply pins can be decoupled at the pin to the ground plane under the IC. This is easily accomplished using surface mount capacitors, which are more effective than leaded components at high frequency.

Using a device socket will unfortunately add to the area and inductance of the external bypass loop.

A ferrite bead or inductor with resistive characteristics at high frequencies may be utilised in the supply line close to the decoupling capacitor to provide a high impedance. To prevent pollution by conduction onto the signal lines (which may then radiate) signals connected to the V_{DD} supply via a pull up resistor should not be connected to the IC side of this ferrite component.

OSCGND should be connected only to the crystal load capacitors and not the local or circuit ground.

Physical connection distances to associated active devices should be short.

Output traces should be routed with close proximity to mutually coupled ground return paths.

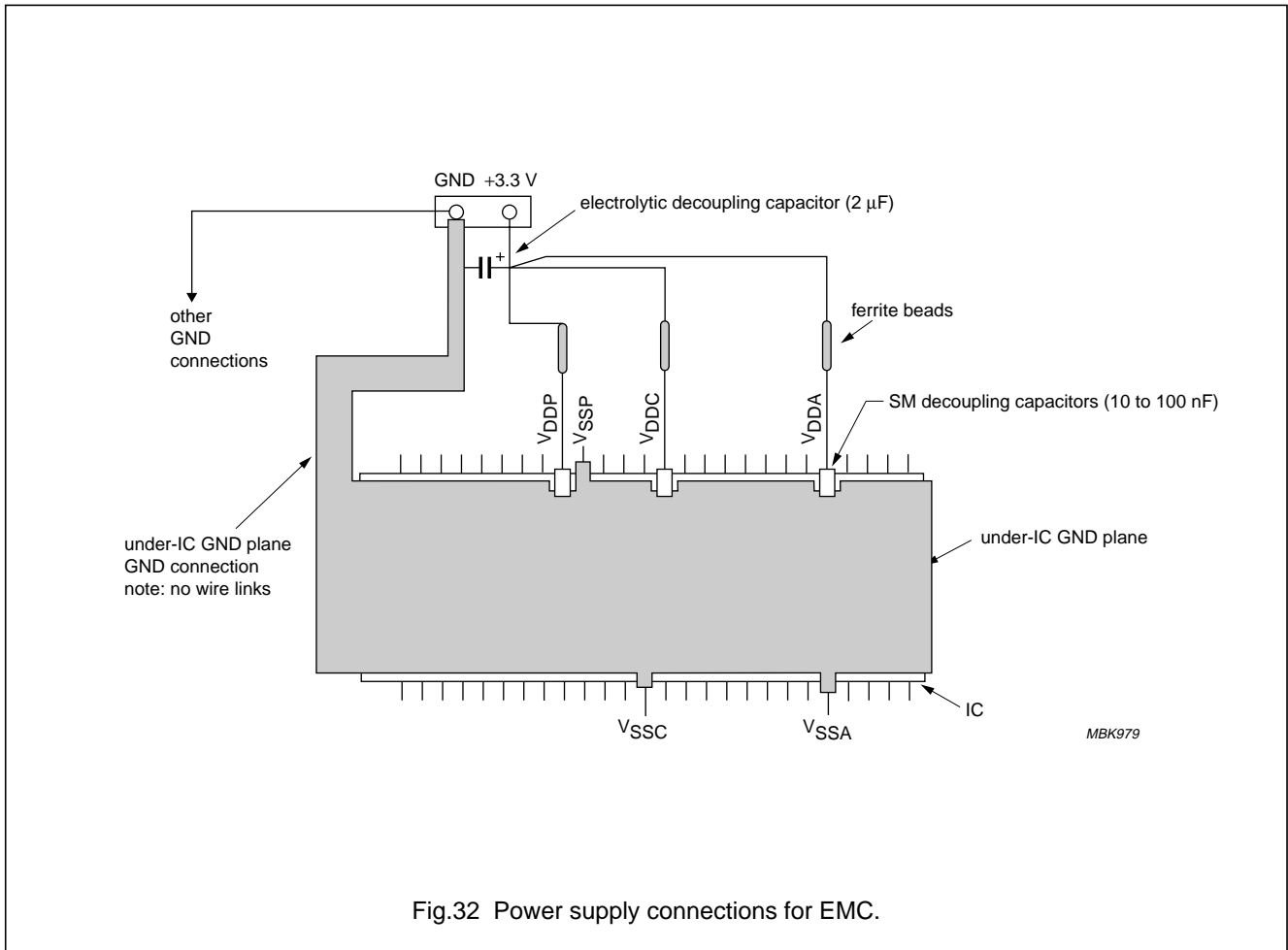

Fig.32 Power supply connections for EMC.

TV microcontrollers with Closed Captioning (CC)
and On-Screen Display (OSD)

SAA55xx

25 PACKAGE OUTLINES

SDIP52: plastic shrink dual in-line package; 52 leads (600 mil)

SOT247-1

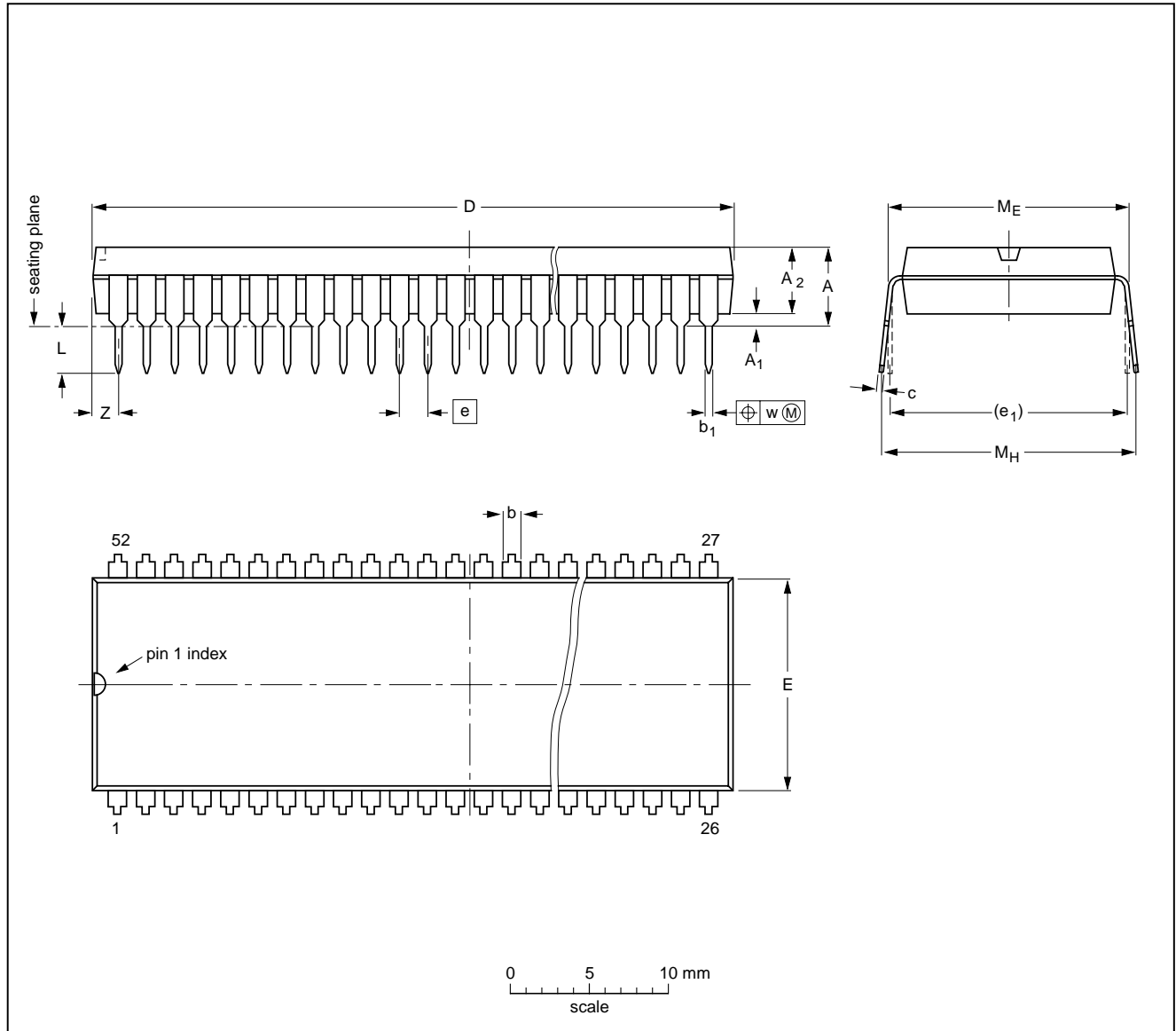

DIMENSIONS (mm are the original dimensions)

UNIT	A max.	A1 min.	A2 max.	b	b1	c	D ⁽¹⁾	E ⁽¹⁾	e	e1	L	ME	MH	w	Z ⁽¹⁾ max.
mm	5.08	0.51	4.0	1.3 0.8	0.53 0.40	0.32 0.23	47.9 47.1	14.0 13.7	1.778	15.24	3.2 2.8	15.80 15.24	17.15 15.90	0.18	1.73

Note

1. Plastic or metal protrusions of 0.25 mm maximum per side are not included.

OUTLINE VERSION	REFERENCES				EUROPEAN PROJECTION	ISSUE DATE
	IEC	JEDEC	EIAJ			
SOT247-1		MS-020				95-03-11 99-12-27

TV microcontrollers with Closed Captioning (CC) and On-Screen Display (OSD)

SAA55xx

LQFP100: plastic low profile quad flat package; 100 leads; body 14 x 14 x 1.4 mm

SOT407-1

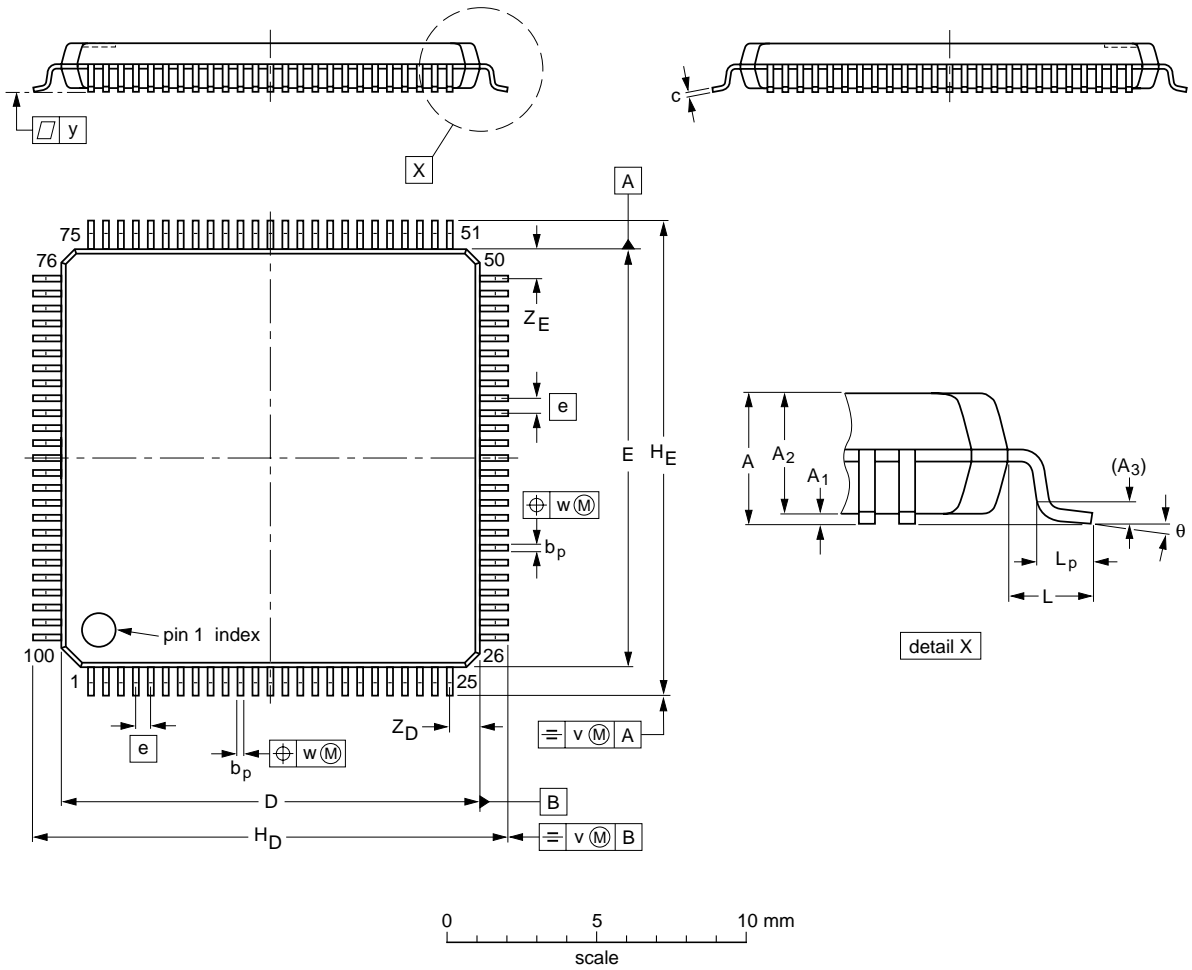

DIMENSIONS (mm are the original dimensions)

UNIT	A max.	A ₁	A ₂	A ₃	b _p	c	D ⁽¹⁾	E ⁽¹⁾	e	H _D	H _E	L	L _p	v	w	y	Z _D ⁽¹⁾	Z _E ⁽¹⁾	θ
mm	1.6	0.15 0.05	1.45 1.35	0.25	0.27 0.17	0.20 0.09	14.1 13.9	14.1 13.9	0.5	16.25 15.75	16.25 15.75	1.0	0.75 0.45	0.2	0.08	0.08	1.15 0.85	1.15 0.85	7° 0°

Note

1. Plastic or metal protrusions of 0.25 mm maximum per side are not included.

OUTLINE VERSION	REFERENCES			EUROPEAN PROJECTION	ISSUE DATE
	IEC	JEDEC	EIAJ		
SOT407-1	136E20	MS-026			00-01-19 00-02-01

TV microcontrollers with Closed Captioning (CC) and On-Screen Display (OSD)

SAA55xx

26 SOLDERING

26.1 Introduction to soldering through-hole mount packages

This text gives a brief insight to wave, dip and manual soldering. A more in-depth account of soldering ICs can be found in our *"Data Handbook IC26; Integrated Circuit Packages"* (document order number 9398 652 90011).

Wave soldering is the preferred method for mounting of through-hole mount IC packages on a printed-circuit board.

26.2 Soldering by dipping or by solder wave

The maximum permissible temperature of the solder is 260 °C; solder at this temperature must not be in contact with the joints for more than 5 seconds.

26.4 Suitability of through-hole mount IC packages for dipping and wave soldering methods

PACKAGE	SOLDERING METHOD	
	DIPPING	WAVE
DBS, DIP, HDIP, SDIP, SIL	suitable	suitable ⁽¹⁾

Note

- For SDIP packages, the longitudinal axis must be parallel to the transport direction of the printed-circuit board.

The total contact time of successive solder waves must not exceed 5 seconds.

The device may be mounted up to the seating plane, but the temperature of the plastic body must not exceed the specified maximum storage temperature ($T_{stg(max)}$). If the printed-circuit board has been pre-heated, forced cooling may be necessary immediately after soldering to keep the temperature within the permissible limit.

26.3 Manual soldering

Apply the soldering iron (24 V or less) to the lead(s) of the package, either below the seating plane or not more than 2 mm above it. If the temperature of the soldering iron bit is less than 300 °C it may remain in contact for up to 10 seconds. If the bit temperature is between 300 and 400 °C, contact may be up to 5 seconds.

TV microcontrollers with Closed Captioning (CC) and On-Screen Display (OSD)

SAA55xx

27 DEFINITIONS

Data sheet status	
Objective specification	This data sheet contains target or goal specifications for product development.
Preliminary specification	This data sheet contains preliminary data; supplementary data may be published later.
Product specification	This data sheet contains final product specifications.
Limiting values	
Limiting values given are in accordance with the Absolute Maximum Rating System (IEC 134). Stress above one or more of the limiting values may cause permanent damage to the device. These are stress ratings only and operation of the device at these or at any other conditions above those given in the Characteristics sections of the specification is not implied. Exposure to limiting values for extended periods may affect device reliability.	
Application information	
Where application information is given, it is advisory and does not form part of the specification.	

28 LIFE SUPPORT APPLICATIONS

These products are not designed for use in life support appliances, devices, or systems where malfunction of these products can reasonably be expected to result in personal injury. Philips customers using or selling these products for use in such applications do so at their own risk and agree to fully indemnify Philips for any damages resulting from such improper use or sale.

29 PURCHASE OF PHILIPS I²C COMPONENTS



Purchase of Philips I²C components conveys a license under the Philips' I²C patent to use the components in the I²C system provided the system conforms to the I²C specification defined by Philips. This specification can be ordered using the code 9398 393 40011.

TV microcontrollers with Closed Captioning (CC)
and On-Screen Display (OSD)

SAA55xx

NOTES

TV microcontrollers with Closed Captioning (CC)
and On-Screen Display (OSD)

SAA55xx

NOTES

Philips Semiconductors – a worldwide company

Argentina: see South America

Australia: 3 Figtree Drive, HOME BUSH, NSW 2140,
Tel. +61 2 9704 8141, Fax. +61 2 9704 8139

Austria: Computerstr. 6, A-1101 WIEN, P.O. Box 213,
Tel. +43 1 60 101 1248, Fax. +43 1 60 101 1210

Belarus: Hotel Minsk Business Center, Bld. 3, r. 1211, Volodarski Str. 6,
220050 MINSK, Tel. +375 172 20 0733, Fax. +375 172 20 0773

Belgium: see The Netherlands

Brazil: see South America

Bulgaria: Philips Bulgaria Ltd., Energoproject, 15th floor,
51 James Bourchier Blvd., 1407 SOFIA,
Tel. +359 2 68 9211, Fax. +359 2 68 9102

Canada: PHILIPS SEMICONDUCTORS/COMPONENTS,
Tel. +1 800 234 7381, Fax. +1 800 943 0087

China/Hong Kong: 501 Hong Kong Industrial Technology Centre,
72 Tat Chee Avenue, Kowloon Tong, HONG KONG,
Tel. +852 2319 7888, Fax. +852 2319 7700

Colombia: see South America

Czech Republic: see Austria

Denmark: Sydhavnsgade 23, 1780 COPENHAGEN V,
Tel. +45 33 29 3333, Fax. +45 33 29 3905

Finland: Sinikalliontie 3, FIN-02630 ESPOO,
Tel. +358 9 615 800, Fax. +358 9 6158 0920

France: 51 Rue Carnot, BP317, 92156 SURESNES Cedex,
Tel. +33 1 4099 6161, Fax. +33 1 4099 6427

Germany: Hammerbrookstraße 69, D-20097 HAMBURG,
Tel. +49 40 2353 60, Fax. +49 40 2353 6300

Hungary: see Austria

India: Philips INDIA Ltd, Band Box Building, 2nd floor,
254-D, Dr. Annie Besant Road, Worli, MUMBAI 400 025,
Tel. +91 22 493 8541, Fax. +91 22 493 0966

Indonesia: PT Philips Development Corporation, Semiconductors Division,
Gedung Philips, Jl. Buncit Raya Kav.99-100, JAKARTA 12510,
Tel. +62 21 794 0040 ext. 2501, Fax. +62 21 794 0080

Ireland: Newstead, Clonskeagh, DUBLIN 14,
Tel. +353 1 7640 000, Fax. +353 1 7640 200

Israel: RAPAC Electronics, 7 Kehilat Saloniki St, PO Box 18053,
TEL AVIV 61180, Tel. +972 3 645 0444, Fax. +972 3 649 1007

Italy: PHILIPS SEMICONDUCTORS, Via Casati, 23 - 20052 MONZA (MI),
Tel. +39 039 203 6838, Fax +39 039 203 6800

Japan: Philips Bldg 13-37, Kohnan 2-chome, Minato-ku,
TOKYO 108-8507, Tel. +81 3 3740 5130, Fax. +81 3 3740 5057

Korea: Philips House, 260-199 Itaewon-dong, Yongsan-ku, SEOUL,
Tel. +82 2 709 1412, Fax. +82 2 709 1415

Malaysia: No. 76 Jalan Universiti, 46200 PETALING JAYA, SELANGOR,
Tel. +60 3 750 5214, Fax. +60 3 757 4880

Mexico: 5900 Gateway East, Suite 200, EL PASO, TEXAS 79905,
Tel. +9-5 800 234 7381, Fax +9-5 800 943 0087

Middle East: see Italy

Netherlands: Postbus 90050, 5600 PB EINDHOVEN, Bldg. VB,
Tel. +31 40 27 82785, Fax. +31 40 27 88399

New Zealand: 2 Wagener Place, C.P.O. Box 1041, AUCKLAND,
Tel. +64 9 849 4160, Fax. +64 9 849 7811

Norway: Box 1, Manglerud 0612, OSLO,
Tel. +47 22 74 8000, Fax. +47 22 74 8341

Pakistan: see Singapore

Philippines: Philips Semiconductors Philippines Inc.,
106 Valero St. Salcedo Village, P.O. Box 2108 MCC, MAKATI,
Metro MANILA, Tel. +63 2 816 6380, Fax. +63 2 817 3474

Poland: Al.Jerozolimskie 195 B, 02-222 WARSAW,
Tel. +48 22 5710 000, Fax. +48 22 5710 001

Portugal: see Spain

Romania: see Italy

Russia: Philips Russia, Ul. Usatcheva 35A, 119048 MOSCOW,
Tel. +7 095 755 6918, Fax. +7 095 755 6919

Singapore: Lorong 1, Toa Payoh, SINGAPORE 319762,
Tel. +65 350 2538, Fax. +65 251 6500

Slovakia: see Austria

Slovenia: see Italy

South Africa: S.A. PHILIPS Pty Ltd., 195-215 Main Road Martindale,
2092 JOHANNESBURG, P.O. Box 58088 Newville 2114,
Tel. +27 11 471 5401, Fax. +27 11 471 5398

South America: Al. Vicente Pinzon, 173, 6th floor,
04547-130 SÃO PAULO, SP, Brazil,
Tel. +55 11 821 2333, Fax. +55 11 821 2382

Spain: Balmes 22, 08007 BARCELONA,
Tel. +34 93 301 6312, Fax. +34 93 301 4107

Sweden: Kottbygatan 7, Akalla, S-16485 STOCKHOLM,
Tel. +46 8 5985 2000, Fax. +46 8 5985 2745

Switzerland: Allmendstrasse 140, CH-8027 ZÜRICH,
Tel. +41 1 488 2741 Fax. +41 1 488 3263

Taiwan: Philips Semiconductors, 6F, No. 96, Chien Kuo N. Rd., Sec. 1,
TAIPEI, Taiwan Tel. +886 2 2134 2886, Fax. +886 2 2134 2874

Thailand: PHILIPS ELECTRONICS (THAILAND) Ltd.,
209/2 Sanpavuth-Bangna Road Prakanong, BANGKOK 10260,
Tel. +66 2 745 4090, Fax. +66 2 398 0793

Turkey: Yukari Dudullu, Org. San. Blg., 2.Cad. Nr. 28 81260 Umraniye,
ISTANBUL, Tel. +90 216 522 1500, Fax. +90 216 522 1813

Ukraine: PHILIPS UKRAINE, 4 Patrice Lumumba str., Building B, Floor 7,
252042 KIEV, Tel. +380 44 264 2776, Fax. +380 44 268 0461

United Kingdom: Philips Semiconductors Ltd., 276 Bath Road, Hayes,
MIDDLESEX UB3 5BX, Tel. +44 208 730 5000, Fax. +44 208 754 8421

United States: 811 East Arques Avenue, SUNNYVALE, CA 94088-3409,
Tel. +1 800 234 7381, Fax. +1 800 943 0087

Uruguay: see South America

Vietnam: see Singapore

Yugoslavia: PHILIPS, Trg N. Pasica 5/v, 11000 BEOGRAD,
Tel. +381 11 3341 299, Fax.+381 11 3342 553

For all other countries apply to: Philips Semiconductors,
International Marketing & Sales Communications, Building BE-p, P.O. Box 218,
5600 MD EINDHOVEN, The Netherlands, Fax. +31 40 27 24825

Internet: <http://www.semiconductors.philips.com>

© Philips Electronics N.V. 2000

SCA 69

All rights are reserved. Reproduction in whole or in part is prohibited without the prior written consent of the copyright owner.

The information presented in this document does not form part of any quotation or contract, is believed to be accurate and reliable and may be changed without notice. No liability will be accepted by the publisher for any consequence of its use. Publication thereof does not convey nor imply any license under patent- or other industrial or intellectual property rights.

Printed in The Netherlands

753504/02/pp84

Date of release: 2000 Feb 23

Document order number: 9397 750 06788

Let's make things better.

Philips
Semiconductors



PHILIPS