

# PC-16T1

The Photocoupler consists of a Gallium Arsenide Infrared Emitting Diode and a Silicon NPN Phototransistor per a channel.  
 The PC-16T1 has one channel in a 4-pin package.

**FEATURES**

- Small Package Size
- Collector-Emitter Voltage : Min.35V
- Current Transfer Ratio : Min.50% (at IF=1mA, VCE=5V)
- Electrical Isolation Voltage : AC2500Vrms
- Creepage/Clearance between Input and Output : Min. 7.0mm
- UL Recognized File No. E107486

**APPLICATIONS**

- Interface between two circuits of different potential
- Vending Machine, Cordless Phone, Key Phone, Fax, Motor Control
- Programmable Logic Control
- Power Supply
- Computer Terminals

**DIMENSION**

(Unit : mm)

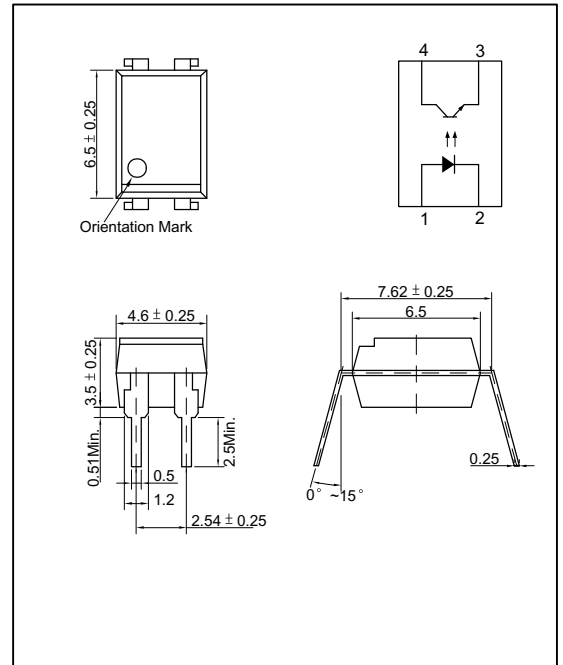

**MAXIMUM RATINGS**

(Ta=25°C)

Parameter		Symbol	Rating	Unit
Input	Forward Current	IF	50	mA
	Reverse Voltage	VR	5	V
	Peak Forward Current *1	IFP	1	A
	Power Dissipation	PD	70	mW
Output	Collector-Emitter Breakdown Voltage	BVCEO	35	V
	Emitter-Collector Breakdown Voltage	BVECO	6	V
	Collector Current	IC	50	mA
	Collector Power Dissipation	PC	150	mW
Input to Output Isolation Voltage *2		Viso	AC2500	Vrms
Storage Temperature		Tstg	-55~+125	°C
Operating Temperature		Topr	-30~+100	°C
Lead Soldering Temperature *3		Tsol	260	°C
Total Power Dissipation		Ptot	200	mW

\*1. Input current with 100µs pulse width, 1% duty cycle

\*2. Measured at RH=40~60% for 1min

\*3. 1/16 inch form case for 10sec

# PC-16T1

**ELECTRO-OPTICAL CHARACTERISTICS**

(Ta=25°C , unless otherwise noted)

Parameter		Symbol	Condition	Min.	Typ.	Max.	Unit.
Input	Forward Voltage	V <sub>F</sub>	I <sub>F</sub> =10mA	-	1.15	1.30	V
	Reverse Current	I <sub>R</sub>	V <sub>R</sub> =5V	-	-	10	μA
	Capacitance	C <sub>T</sub>	V=0, f=1MHz	-	30	-	pF
Output	Collector-Emitter Breakdown Voltage	BV <sub>CEO</sub>	I <sub>C</sub> =0.5mA	35	-	-	V
	Emitter-Collector Breakdown Voltage	BV <sub>ECO</sub>	I <sub>E</sub> =0.1mA	6	-	-	V
	Collector Dark Current	I <sub>CEO</sub>	I <sub>F</sub> =0, V <sub>CE</sub> =24V	-	-	100	nA
	Capacitance	C <sub>CE</sub>	V <sub>CE</sub> =0, f=1MHz	-	10	-	pF
Coupled	Current Transfer Ratio <sup>*4</sup>	CTR	I <sub>F</sub> =1mA, V <sub>CE</sub> =5V	50	-	600	%
	Collector-Emitter Saturation Voltage	V <sub>CE(SAT)</sub>	I <sub>F</sub> =5mA, I <sub>C</sub> =1mA	-	0.15	0.4	V
	Input-Output Capacitance	C <sub>IO</sub>	V=0, f=1MHz	-	1	-	pF
	Input-Output Isolation Resistance	R <sub>IO</sub>	RH=40~60%, V=500V	-	10 <sup>11</sup>	-	Ω
	Rise Time	t <sub>r</sub>	V <sub>CE</sub> =5V, R <sub>L</sub> =100Ω	-	4	-	μs
	Fall Time	t <sub>f</sub>	I <sub>C</sub> =2mA	-	4	-	μs

\*4. CTR=(I<sub>C</sub>/I<sub>F</sub>) X 100 (%)

# PC-16T1

**Forward Current vs. Ambient Temperature**

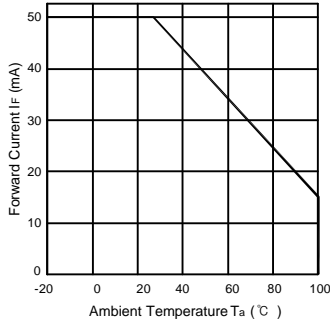

**Collector Power Dissipation vs. Ambient Temperature**

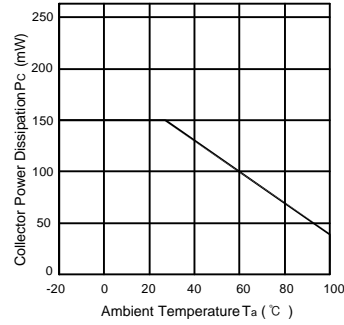

**Forward Current vs. Forward Voltage**

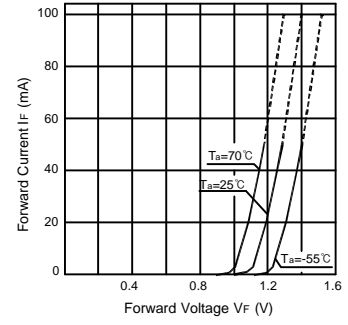

**Collector Current vs. Collector-Emitter Voltage**

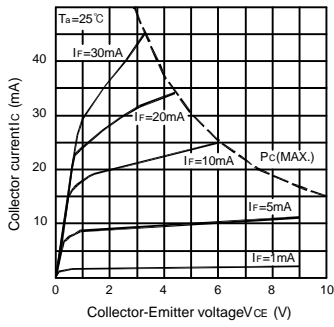

**Dark Current vs. Ambient Temperature**

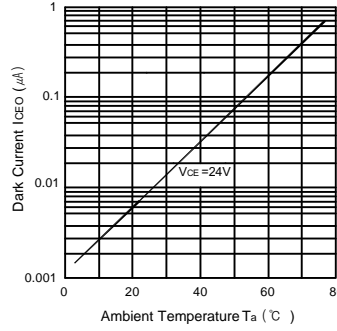

**Collector Current vs. Ambient Temperature**

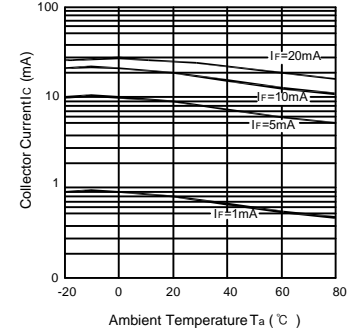

**Response Time vs. Load Resistance**

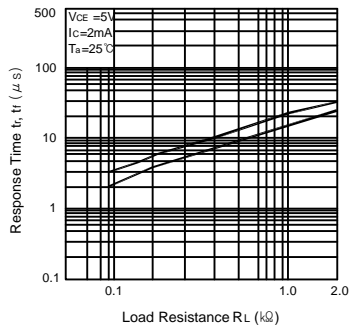

**Collector Current vs. Forward Current**

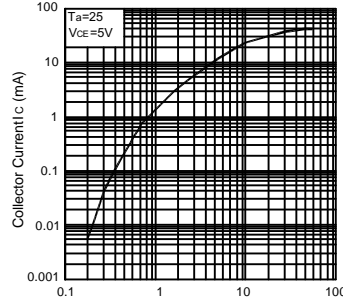

**Switching Time Test Circuit**

