

Panasonic

Digital Cordless Phone

Operating Instructions

Model No. **KX-TCD450NZ**

Contents

Preparation

Before Initial Use.....	2
Important Information.....	3
Setting up.....	4

Cordless Telephone

Using the Telephone.....	8
Making Calls.....	11
Caller ID.....	12
Phonebook.....	16
Handset Settings.....	24
Base Unit Settings.....	30
Initial Settings.....	32
Multi-unit User Operation.....	34
Intercom.....	38
Walkie-Talkie.....	39

Useful Information

Using the Belt Clip.....	41
Optional Headset.....	41
Wall Mounting.....	41
Before Requesting Help.....	42
Technical Information.....	44
Index.....	45



Preparation

Cordless Telephone

Useful Information

Caller ID Compatible

PLEASE READ BEFORE USE AND SAVE.

Charge the battery for about 7 hours before initial use.

Before Initial Use

Thank you for purchasing your new Panasonic digital cordless telephone.

Dear purchaser,

You have acquired a KX-TCD450NZ, which is a product made in regard with the Digital Enhanced Cordless Telecommunications (DECT). DECT technology is characterized by high-security protection against interceptions as well as high-quality digital transmission. This telephone was designed for a wide range of applications. For example, this telephone can be used within a network of base units and handsets, constituting a telephone system which:

- operates up to 6 handsets at one base unit.
- allows an intercom between 2 handsets.
- allows the operation of a handset at up to 4 base units, expanding the communication radio area.

Caller ID Service, where available, is a telephone company service. After subscribing to Caller ID, this phone will display the caller's phone number.

Accessories (included)

AC Adaptor
PQLV19AL

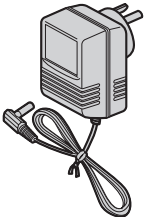

Telephone Line Cord



Rechargeable Batteries
(AAA size)
HHR-4EPT/BA2
(HHR-4EPT)



Battery Cover

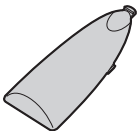

Belt Clip



Additional accessories are available for purchase. Contact your Panasonic Service Centre for further details.

General Warning:

The grant of a Telepermit for any item of terminal equipment indicates only that Telecom has accepted that the item complies with minimum conditions for connection to its network. It indicates no endorsement of the product by Telecom, nor does it provide any sort of warranty. Above all, it provides no assurance that any item will work correctly in all respects with another item of Telepermitted equipment of a different make or model, nor does it imply that any product is compatible with all of Telecom's network services.

Only use the power supply included with the product.

Do not connect the AC Adaptor to any AC outlet other than the standard AC230 V.

The apparatus is approved for use with PQLV19AL power supply.

This apparatus is unable to make emergency telephone calls under the following conditions:

- The portable handset batteries need recharging, or have failed.
- During a mains power failure.
- When the Key Lock is set to ON.
- When the unit is in Direct Call mode.

Do not open the base unit or handset (other than to change the batteries).

This apparatus should not be used near emergency/intensive care medical equipment and should not be used by people with pacemakers.

Care should be taken that objects do not fall onto, and liquids are not spilled into the unit. Do not subject this unit to excessive smoke, dust, mechanical vibration or shock.

Environment

Do not use this unit near water.

This unit should be kept away from heat sources such as radiators, cookers, etc. It should also not be placed in rooms where the temperature is less than 5 °C or greater than 40 °C.

The AC Adaptor is used as the main disconnect device. Ensure that the AC outlet is located/installed near the unit and is accessible.

WARNING:

TO PREVENT THE RISK OF ELECTRICAL SHOCK, DO NOT EXPOSE THIS PRODUCT TO RAIN OR ANY OTHER TYPE OF MOISTURE.

Battery Caution

Use only specified batteries.

Only use rechargeable batteries.

Do not mix old and new batteries.

Do not dispose of batteries in a fire, as they may explode.

Check local waste management codes for special disposal instructions.

Do not open or mutilate the batteries.

Released electrolyte is corrosive and may cause burns or injury to the eyes or skin.

The electrolyte may be toxic if swallowed.

Exercise care in handling the batteries in order not to short the batteries with conductive materials such as rings, bracelets and keys.

The batteries and/or conductor may overheat and cause burns.

Charge the batteries provided in accordance with the information given in this operating guide.

Location

- For maximum distance and noise-free operation, place your base unit:
 - Away from electrical appliances such as TVs, radios, personal computers or other phones.
 - In a convenient high and central location.

Setting up

◆◆ Connection

Plug in the AC adaptor and the telephone line cord in order **1, 2, 3, 4**.

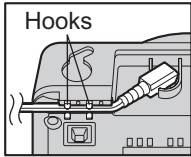

Fasten the AC adaptor cord to prevent it from being disconnected.

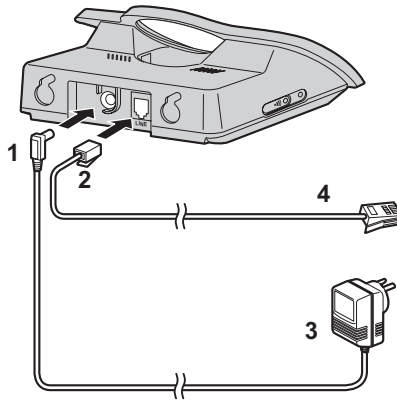

The AC adaptor must remain connected at all times. (It is normal for the adaptor to feel warm during use.)

- Never install telephone wiring during a lightning storm.

◆◆ Battery Installation

Please ensure the batteries are inserted as shown. ⊖ part should be inserted first. Close the cover as indicated by the arrow.

- When you replace the batteries, ⊕ part should be removed first.

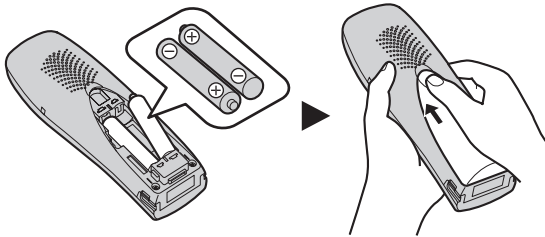

To replace the batteries:

Press the notch on the cover firmly and slide it as indicated by the arrow. Replace both batteries and close the cover then charge the handset for about 7 hours.



◆◆ Battery Charge

At the time of shipment, the batteries are not charged. To charge, place the handset on the base unit. **Please charge the batteries for about 7 hours before initial use.** During charging, the battery icon is as shown below.

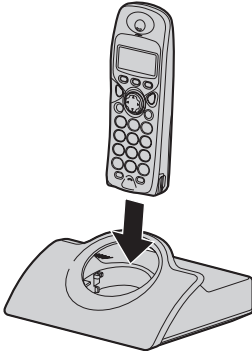

Fully charged

During charging

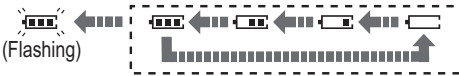

Display icon	Battery strength
	High
	Medium
	Low
	Needs to be charged

The handset, when off, will be turned on automatically when it is placed on the base unit.

In normal use, the handset and the base unit should be turned on at all times.

◆◆ Battery Life

Battery life is dependent on use and conditions but in general when using fully charged Ni-MH batteries (700 mAh):

Talk time: 10hrs approx.

Standby time: 120hrs approx.

When using Ni-Cd batteries (250 mAh):

Talk time: 4hrs approx.

Standby time: 40hrs approx.

(Times indicated are for peak performance.)

The batteries reach peak performance after several full charge/discharge cycles. The batteries cannot be overcharged unless they are repeatedly removed and replaced.





If battery life is shortened then please check that battery and charge terminals are clean.

For maximum battery life, it is recommended that the handset not be recharged until the battery icon flashes

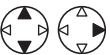

Setting up

◆◆ Symbols Used in This Operating Instructions

Symbol	Meaning
	To search for the desired item, press UP or DOWN .
	To select the desired item, press RIGHT .
	To search for and then select the desired item, press UP or DOWN then RIGHT .
	To move the cursor to the right or to the left, press RIGHT or LEFT .
	To go to the next step.
" "	The words in " " indicate the words in display.

◆◆ Replacing the Batteries





If the  icon flashes after a few telephone calls even when the handset batteries have been fully charged, both batteries must be replaced.

Charge new batteries for approximately 7 hours before initial use.

(The telephone line cord must not be connected to the telephone socket at this time.)

When replacing the batteries, ensure that the correct battery type is selected.

Selecting the Battery Type

1 	2 	3 	4 
Press MENU .	Search/Select "Setting Handset".	Search/Select "Other Option".	Search/Select "Battery Type".
5 	Search/Select "Ni-Cd" or "Ni-MH".		

- To exit the operation, press  any time.
- Do not use non-rechargeable batteries. If non-rechargeable batteries are fitted and start charging, it may cause the leakage of the battery electrolyte.

Please use only Panasonic HHR-4EPT(Ni-MH) or P-4NPT(Ni-Cd) batteries.

◆◆ Location of Controls

Handset

Rear side

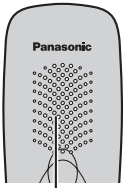

Speaker

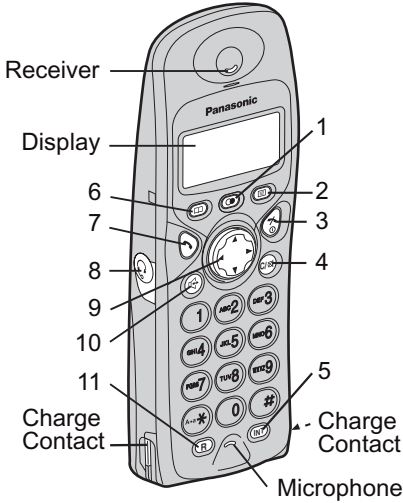

- 1 - **REDIAL/PAUSE** Button
- 2 - **MENU/OK** Button
- 3 - **OFF/POWER** Button
- 4 - **CLEAR/MUTE** Button
- 5 - **INTERCOM** Button
- 6 - **PHONEBOOK** Button
- 7 - **TALK** Button
- 8 - **Headset Jack**
- 9 - **Navigator Key**
- 10 - **SPEAKERPHONE** Button
- 11 - **RECALL** Button

Base unit

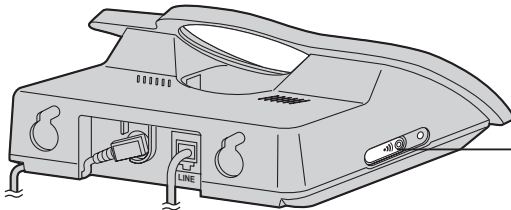

- PAGE** Button and Indicator

◆◆ Handset Display

- Within range of a base unit
- Out of range/No registration/
No power on base unit
- Paging
- Making or answering calls
- Battery strength is low.
- Battery strength is high.
- Call Bar On** (p. 27)
- Direct Call On** (p. 28)
- Key Lock On** (p. 29)

Using the Telephone

◆◆ Power On/Off

Power on



Press for more than
2 seconds.*1

Power off







Press for more than
2 seconds.*2

*1 When  button is released, the display changes to the standby mode.

*2 The display goes blank.





◆◆ Setting the Clock/Date

After a mains power failure the clock needs to be reset. Ensure that the  icon is not flashing.

1  Press MENU .	2  Search/Select "Setting Base".	➔ "Input Command"
3 $\left(\begin{array}{l} \text{Time} \\ \text{OR} \\ \text{Date} \end{array} \right)$ $\left(\begin{array}{l} \text{✖} \text{ Enter time. 4-digit.*1} \text{ } \text{✖} \text{ Select AM or PM.*2} \\ \text{✖} \text{ twice} \text{ } \text{✖} \text{ Enter day, month then year.*3} \end{array} \right)$		4  Press OK .

• To exit the operation, press  any time.

*1 You can enter the time in 12 hour clock or 24 hour clock.

For example, to set 7:15 (12 hour clock), press    .

If you enter the time in 24 hour clock, go to step 4.

*2 If AM or PM is not selected, display will show 24 hour clock even if the time has been entered in 12 hour clock.

*3 For example, to set the 16th of February, 2003, press      .

◆◆ Making a Call

Pre-dialling

1 Phone Number *1

2



Press **TALK**.*2

Post-dialling

1



Press **TALK**.*2

2 Phone Number

*1 If you need to make a correction, press **CLEAR**. The digit is cleared to the left, then you can enter numbers. All digits are cleared if you press and hold **CLEAR**.

*2 You can also press **SPEAKERPHONE** to make a call.

Using the Telephone

◆◆ Answering a Call

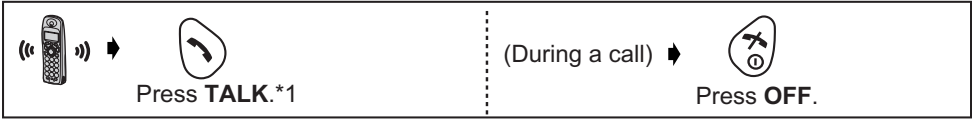

Terminating a Call

*1 You can also answer a call by pressing a dialling button, **INTERCOM**, **#**, ***** or **SPEAKERPHONE**.

◆◆ Auto Talk

If you set Auto Talk to on, you can answer the phone by lifting the handset off the base unit.

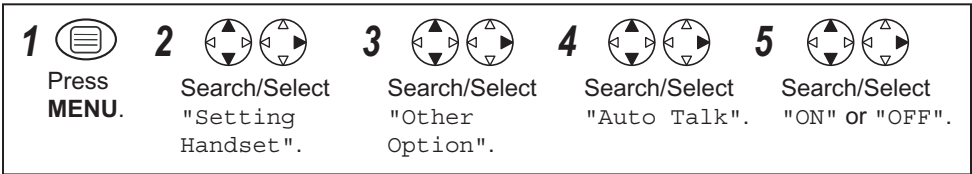

- To exit the operation, press any time.

◆◆ Temporary Bell Off

When an external call is ringing, you can temporarily turn off the handset ringer. This function will not work when the handset is on the base unit or if an internal call is ringing.



◆◆ Receiver Volume/Speaker Volume

During a call, press **UP** or **DOWN** to change the receiver/speaker volume setting. There are 6 levels for speaker volume, and 3 levels for receiver volume.



Using the Telephone

◆◆ Handset Locator/Paging

You can locate a misplaced handset by paging it.

1 Press  on the base unit. **2** All registered handsets ring for 1 minute.

<To stop paging>

3 Press  on the base unit OR *1 on one of the handsets.

*1 You can also stop paging by pressing a dialling button, **INTERCOM**, **#**, ***** or **SPEAKERPHONE**.

◆◆ Speakerphone

Have a Hands-Free Phone Conversation (using Digital Speakerphone)

Handsfree allows you to talk to your caller without holding the handset and allows other persons in the room to listen to the conversation.

1 
Press **SPEAKERPHONE**.

2 Phone Number **3** 
Press **OFF**
to finish conversation.

- For best performance, please note the following:
 - Talk alternately with the caller in a quiet environment.
 - If either party has difficulty hearing, press **UP** or **DOWN** to change the volume accordingly. The choices for the receiver (or headset receiver) volume are 3 levels, and 6 levels for speakerphone volume.
 - During a conversation you can switch to hands-free by pressing **SPEAKERPHONE**. To switch back to the receiver, press **TALK** or **SPEAKERPHONE**.

◆◆ Turning the Mic On/Off

During a telephone conversation, you can mute the mic. When the mic is turned off, it disables the caller from hearing your conversation. This feature is useful if you want to say something to someone in the same room as yourself without the caller being able to hear your conversation.

(During a call) **1**  Press **MUTE** to turn the mic off.

2  Press **MUTE** to return to the conversation.

3  Press **OFF** to finish conversation.

◆◆ Redialling







The last 10 numbers dialled are stored in the redial list automatically.

Dialling with the Redial List





1  Press REDIAL .*1	2  Search for the desired dialled item.	3  Press TALK .*2	1  Press TALK .*3	2  Press REDIAL .
---	--	---	---	--

Dialling the Last Number Dialled

Editing the Dialled Number in the Redial List

1  Press REDIAL .*1	2  Search/Select the desired dialled item.	3  Search/Select "Edit For Call".	▶ The 1st digit of the desired dialled number blinks.
4  Move the cursor.	5  Press CLEAR .*4	AND/OR Edit the phone number.*5	▶ Name Follow from step 3 on page 16.
6  Press TALK .*2 OR  Press OK twice to store the number.			

Clearing One/All Dialled Item(s) in the Redial List

1  Press REDIAL .*1	2  Search/Select the desired dialled item.	3  Search/Select "Clear" or "All Clear".	4  Search/Select "YES".
---	---	---	--

- To exit the operation, press  any time.
- *1 If there is no item stored in the redial list, the display shows "No Stored Memory".
- *2 You can also press **SPEAKERPHONE** to make a call.
- *3 If the other party's line is busy, the call is redialled automatically when dialling with **SPEAKERPHONE** (Auto Redial). When using Auto Redial, press **SPEAKERPHONE** again after pressing **REDIAL** if the muting has not be cancelled.
- *4 Digits are cleared to the left of the flashing digit.
- *5 Digits are added to the left of the flashing digit. If you need to clear and/or add more than one number, repeat from step 4.

Caller ID

◆◆ Caller ID Service

Caller ID is a service of your Network provider and will only operate if you have subscribed to this feature.

After subscribing to Caller ID, this phone will display the caller information.

If your unit is connected to a PBX or a telephone line that does not support this service, you will not be able to use it.

Caller ID does not display caller information while using the handset for an intercom call. However, the caller information will be stored to the Caller ID List.

For all local and national incoming calls put, your display will show the area code (e.g. 09 for Auckland) or the cellular prefix (e.g. 025 for Telecom Cellular) followed by the caller's telephone number. An Auckland caller's number will be displayed as 09XXXXXXXX. The seven X's represent the seven digits of the caller's telephone number. A call from a 7-digit Telecom Cellular number will be displayed as 025XXXXXXXX. For incoming international calls put, your display may only show the digits "0000". For business users on a Centrex line, your display will show the Centrex extension numbers in the shorter extension number format used within your company.

Call Waiting: Call Waiting is a service of your Network provider and will only operate if you have subscribed to this service.

You can answer the second call, keeping the first call on hold.

Please consult your Network provider for details of this service.

◆◆ For Using Telecom's or Another Company's Toll Services

Your telephone company may charge you for a local call if the number dialled has the area code prefix included. If the charge for local call is unacceptable, only the 7-digits of the local number should be dialled from your telephone. Do not dial the "0" prefix or the area code digit.

◆◆ Caller ID Display

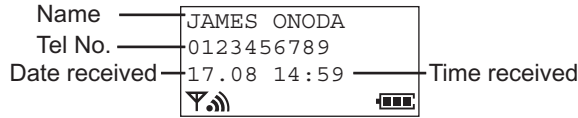

When receiving a call, the display shows the caller's phone number. For example, a caller whose phone number is 0123456789 has been received. If you store a phone number with a name in the phonebook, the display also shows caller's name when receiving a call.

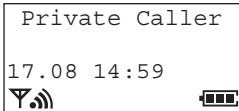

If the caller has requested not to display his/her information, the display shows "Private Caller".

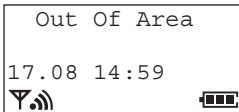

If the caller dialed from an area which does not provide Caller ID service, the display shows "Out Of Area".

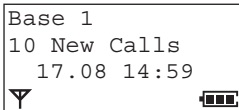

When new calls have been received, the display shows the number of calls. In the example on the left, 10 new calls have been received.

Caller ID

◆◆ Caller ID List

Information from up to 50 different callers is stored from the most recent call to the oldest call in the caller list. When the 51st call is received, the oldest caller information is cleared.







If you receive a call from the same phone number you stored with name in the phonebook, the display will show the caller's name.

Calling Back

1  Search for the desired received item.*1	2  Press TALK .*2
--	--



Editing a Received Number in the Caller List

The caller's telephone number, which is sent to your telephone from your local telephone exchange, includes the "0" and area code prefix. For local calls, the "0" and area code prefix can be omitted. See page 12 "For Using Telecom's or Another Company's Toll Services" for more information.

1  Search/Select the desired received item.*1	2  Search/Select "Edit For Call".	3  Move the cursor.
4  Press CLEAR .*3	Number Edit the number.*4	5  Press TALK .*2 OR  Press OK twice to store the number.
		▶ The 1st digit of the desired received number blinks.
		▶ Name Follow from step 3 on page 16.

- To exit the operation, press  any time.
- *1 If there is no item stored in the caller list, the display shows "No Stored Memory". When you answer a call, the caller information is stored in the list with a "✓" next to it. A "✓" will also be displayed next to an item after you have viewed it in the caller list.
- *2 You can also press **SPEAKERPHONE** to make a call.
- *3 Digits are cleared to the left of the flashing digit.
- *4 Digits are added to the left of the flashing digit. If you need to clear and/or add more than one number, repeat from step 3.

Clearing One/All Received Item(s) in the Caller List

1		2		3	
	Search/Select the desired received item.*1		Search/Select "Clear" or "All Clear".		Search/Select "YES".

- To exit the operation, press  any time.
- *1 If there is no item stored in the caller list, the display shows "No Stored Memory". When you answer a call, the caller information is stored in the list with a "✓" next to it. A "✓" will also be displayed next to an item after you have viewed it in the caller list.







Phonebook

You can store information from up to 200 callers in the phonebook. If you subscribe to caller ID and you receive a call from the same phone number you stored with a name in the phonebook, the display will show the caller's name.

Private Category Feature

You can categorise caller information in the phonebook. There are 9 categories available. For example, category 1 can be used to save all friends' numbers. For each category, you can select one of 20 ringer types (see "Handset Settings"). **This feature is only available after subscription to Caller ID.** Please contact your Network provider for further information.

◆◆ Storing a Caller Information

1  Press MENU .	2  Search/Select "New Phonebook".*1	3 Name Enter name. (max. 16 characters)*2	4  Press OK .
5 Phone Number Enter phone number. (max. 24 digits)*2	6  Press OK .	7  Search/Select Private Category number (1-9) or "OFF".	8  Select "Save".*3

- To exit the operation, press  any time.







*1 The display shows the number of phonebook space available. If "Memory Full" is displayed, the phonebook is full. To store, clear other stored items in the phonebook.

*2 If you need to make a correction, press **RIGHT** or **LEFT** to move the cursor then clear the character/digit by pressing **CLEAR**, and/or enter characters/digits. Characters/digits are cleared or added to the left of the flashing character/digit. To enter characters, see page 19.

*3 To continue storing another caller information, repeat from step 3.

To change capital or lower case letters

Example: Enter the name using the letters on the keypad. For example, to enter Anne:





1 	2 	3 	4  twice	5 	6  twice	7  twice
--	--	--	--	--	--	--

- Pressing  changes between upper and lower case.







To change the Character Mode

You can select one of 6 character modes by pressing **PHONEBOOK** while entering a name. The factory preset is "ABC".

For the full character map, see Phonebook Character Table (p. 19).

<p>1  Press MENU.</p>	<p>2  Search/Select "New Phonebook".</p>	<p>3 Name Enter name. (max. 16 characters)</p>	<p>4  Press PHONEBOOK while entering name.</p>
<p>5  Search/Select the desired character mode.</p>			

To enter Names/Characters in the phonebook

Button	Note
	Press to move the cursor.
 to 	Press to enter letters/numbers. (Items are added to the left of the cursor. If the cursor is at the beginning of a line, the item is added over the cursor.)
	Press to delete characters. (Characters are deleted to the left of the cursor. If the cursor is at the beginning of a line, the first character will be deleted.) Press and hold to delete all characters.
	Press to change between upper and lower case.
	Press to insert a blank space (except when in Numeric 0-9 character mode).
	Press to insert a symbol (except when in Numeric 0-9 character mode).

- To enter two characters located on the same dialling button, enter the first character and then press **RIGHT** to move the cursor on one space to enter the next character.

Phonebook

◆◆ Finding Items in the Phonebook

All phonebook items are stored in the following order: Alphabet Letter/Symbol/Number/Telephone number (when a name is not stored).

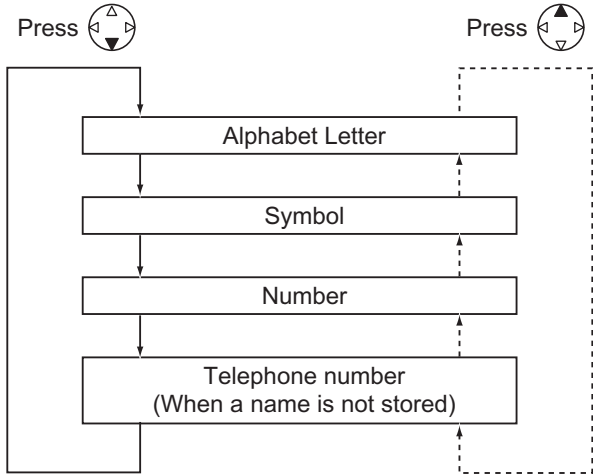

1  Press PHONEBOOK .	➔ The first item is displayed.	2  Search for the desired item.*1
--	--------------------------------	--

*1 Display order of characters













To Search for a Name by Initial

For example: “Felix”

1  Press PHONEBOOK .	➔ The first item is displayed.	2 Press dialling button 3 repeatedly until the first item under “F” is displayed.	3  Press DOWN until “Felix” is displayed.
--	--------------------------------	---	---

Phonebook



Editing Caller Information

1  Press PHONEBOOK . ^{*1}	2  Search/Select desired item.	3  → The 1st character of the desired name blinks.
<Name>		
4  Move the cursor.	5  Press CLEAR . ^{*2}	AND/OR Name 6  Press OK . Edit the name. ^{*3}
<Phone Number>		
7  Move the cursor.	8  Press CLEAR . ^{*4}	AND/OR Number 9  Press OK . Edit the phone number. ^{*5}
10  Search/Select Private Category number (1-9) or "OFF".	11  Select "Save".	

Clearing Caller Information

1  Press PHONEBOOK . ^{*1}	2  Search/Select desired item.	3  Search/Select "Clear".	4  Search/Select "YES". ^{*6}
--	---	--	--

Dialling with the Phonebook

1  Press PHONEBOOK . ^{*1}	2  Search for the desired item.	3  Press TALK . ^{*7}
--	--	---

- To exit the operation, press  any time.
- *1 If there is no item stored in the phonebook, the display shows "No Stored Memory".
- *2 Characters are cleared to the left of the flashing character.
- *3 Characters are added to the left of the flashing character. If you need to clear or add more than one character, repeat from step 4.
- *4 Digits are cleared to the left of the flashing digit.
- *5 Digits are added to the left of the flashing digit. If you need to clear or add more than one digit, repeat from step 7.
- *6 To continue clearing another caller information, repeat from step 2.
- *7 You can also press **SPEAKERPHONE** to make a call.



◆◆ Storing a Phone Number (Pre-dialling/Redial List/ Caller ID List)

<Pre-dialling>

Phone Number*1 →  Press **RIGHT**.

1 <Redial List>



 Press **REDIAL.*2**

→   Search/Select the desired dialled number.

2  Select "Save Phonebook".



3 Name
Enter name. (max. 16 characters)*3

4  Press **OK** twice.

5   Search/Select Private Category number (1-9) or "OFF".

6  Select "Save".

<Caller ID List>

1   Search/Select the desired received number.*2

2  Select "Save Phonebook".

3 Name
Follow from step 3 above.

• To exit the operation, press  any time.

*1 If you need to make a correction, press **CLEAR**. The digit is cleared to the left, then you can enter numbers.

*2 If there is no item stored in the redial/caller ID list, the display shows "No Stored Memory".





*3 If you need to make a correction, press **RIGHT** or **LEFT** to move cursor then clear a character by pressing **CLEAR**, and/or enter characters. Characters are cleared or added to the left of the flashing character. To enter characters, see Phonebook Character Table on page 19.

Phonebook

◆◆ Hot Key

You can assign the dialling buttons 1 through 9 as hot keys. You can choose phone numbers from the phonebook.

Registering a Phone Number as a Hot Key

1  Press PHONEBOOK . ^{*1}	2  Search/Select desired item.	3  Search/Select "Reg. To Hot Key".	4  Search/Select desired dialling button number. ^{*2}
5  Select "Save".			

Dialling with a Hot Key

1 Press and hold the dialling button registered as a hot key.	2  Press TALK . ^{*3}
--	---

Clearing Hot Key Registration

1 Press and hold the dialling button registered as a hot key.	2  Press RIGHT .	3  Select "Clear".	4  Search/Select "YES". ^{*4}
--	--	---	--

- To exit the operation, press  any time.
- *1 If there is no item stored in the phonebook, the display shows "No Stored Memory".
- *2 If an item is already stored to a hot key, "✓" will be displayed on the left of the key number. If a hot key number with "✓" is selected, press **RIGHT** to select "Overwrite".
- *3 You can also press **SPEAKERPHONE** to make a call.
- *4 Phonebook registration will not be erased when hot key registration is cleared.

◆◆ Phonebook Copy

You can copy phonebook information between handsets registered to the same base unit. The phonebook copy must be performed while in intercom mode.

To Copy an item/All items in the Phonebook

For example, Handset 2 is copying an item from its phonebook to Handset 1.

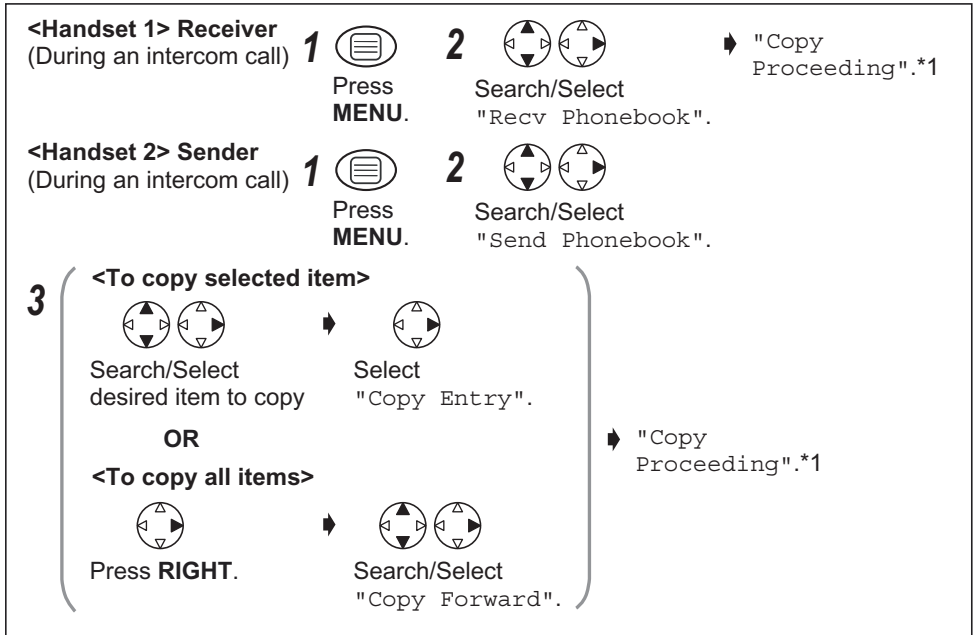

- To cancel copying at any time, press **CLEAR** to return to the intercom call or press  to return to the standby mode.

*1 If "Memory Full" is displayed, the receiver handset memory is full. When copying is completed, a beep sounds and "Copy Complete" is displayed. After a few seconds, the display will return to the intercom call. "Copy Incomplete" will display if the receiver handset memory is full. If "Copy Failure" is displayed, the receiver and/or sender did not prepare for copying within 60 seconds.

Handset Settings

◆◆ Time Alarm

Before programming, please follow steps 1 to 3.

You must set the clock before setting the time alarm.



Press **MENU**.



Search/Select

"Setting Handset".



Search/Select

"Time Alarm".

Setting Alarm Time



Search/Select

"Set Alarm
Time".



Enter time.

4-digit
(24 hour clock)



Press **OK**.



Select

"Save".



Search/Select

"OFF",
"Once" or
"Repeat Daily".

Setting Time Alarm On/Off



Search/Select

"Alarm ON/OFF".



Search/Select

"OFF",
"Once" or
"Repeat Daily".

- To exit the operation, press  any time.

To stop the time alarm: Time alarm will sound for 3 minutes. When the alarm sounds, press a dialling button, **TALK**, **#**, ***** or **SPEAKERPHONE**. The alarm stops and display returns to the standby mode.

If "Once" is selected, the setting is turned off. When in talk or intercom mode, the alarm will not sound until the call is ended.

◆◆ Ringer Option

Before programming, please follow steps 1 to 3.



Press **MENU**.



Search/Select
"Setting Handset".



Search/Select
"Ringer Option".

Setting the Ringer Volume

The choices are 6 levels and off.



Search/Select
"Ringer Volume".



Search/Select
desired ringer volume.

- If "OFF" is selected, "Ring Off" is displayed.

Setting the Ringer Pattern for External Call/Internal Call/Paging/Alarm

There are 20 patterns available on each ringer.



Search/Select
"Ext Ring Type",
"Int Ring Type",
"Paging Type" or
"Alarm Type".



Search/Select
desired ringer pattern.*1

Selecting the Ringer Pattern for Private Ring



Search/Select
"Private Ring".



Search/Select
desired category number (1-9).



Search/Select
desired ringer pattern.*1

- To exit the operation, press  any time.

*1 If you select one of the melody ringer pattern, it keeps ringing for 10 seconds even if a caller hang up a call. Therefore, you may hear dial tone or no one there after you answer a call.

Handset Settings

◆◆ Tone Option





You can set the following sounds on or off.

Key Tone: A key tone will sound when you press any key, and a confirmation tone and an error tone will be heard during operation.

Call Waiting Tone: A call waiting tone will sound when an incoming external call is received during an intercom call.

Range Warning Alarm: An alarm will sound when you move out of range of a base unit.





Battery Low Alarm: An alarm will sound when the batteries need to be charged.

1  Press MENU .	2  Search/Select "Setting Handset".	3  Search/Select "Tone Option".	4  Search/Select "Key Tone ON/OFF", "Call Waiting", "Range Alarm" or "Battery Alarm".
5  Search/Select "ON" or "OFF".			

- To exit the operation, press  any time.

◆◆ Display Option

Selecting the Standby Mode Display

1  Press MENU .	2  Search/Select "Setting Handset".	3  Search/Select "Display Option".
4  Search/Select "Standby Display".	5  Search/Select "Base Number"(Base unit number), "Handset Number"(Handset number) or "OFF".	

- To exit the operation, press  any time.

Handset Settings

Before programming, please follow steps 1 to 3.



Press **MENU**.



Search/Select
"Setting Handset".



Search/Select
"Display Option".

Selecting the Talk Mode Display

Even if you select "Phone No. ", the length of the call will appear on your display when you receive calls.



Search/Select
"Talk Display".



Search/Select
"Talk Time" (Length of the call) or
"Phone No." (Phone number).

Selecting the Display Language



Search/Select
"Select Language".



Search/Select
desired language.*1

- To exit the operation, press  any time.

*1 You can select one of 24 languages. If you set a language you cannot read, reset the handset to its initial settings. Press **MENU** \rightarrow **DOWN** \rightarrow **RIGHT** \rightarrow **UP** \rightarrow **RIGHT** \rightarrow **4-digit Handset PIN** \rightarrow **UP** \rightarrow **OK**.

All handset setting will be reset to their initial settings (p. 32), however, the Phonebook data will be saved.

◆◆ Call Option

Call Bar On/Off

This allows you to bar all calls except emergency and internal calls.



Press **MENU**.



Search/Select
"Setting Handset".



Search/Select
"Call Option".



Search/Select
"Call Bar".

5 **4-digit Handset PIN***1



Search/Select
"ON" or "OFF".*2

- To exit the operation, press  any time.

*1 The factory preset is 0000.

*2 If "ON" is selected,  is displayed.

Handset Settings

Before programming, please follow steps 1 to 3.



Press **MENU**.



Search/Select

"Setting Handset".



Search/Select

"Call Option".

Setting the Direct Call Number

After a direct call number has been set and the feature has been turned on, you can dial the direct call number only by pressing **TALK** or **SPEAKERPHONE**. Incoming calls are accepted.



Search/Select

"Direct Call No.".

5 Phone Number

Enter the direct call number. (max. 24 digits)



Press **OK** 3 times.*1

Setting the Direct Call On/Off



Search/Select

"Direct ON/OFF".



Search/Select

"ON" or "OFF".*1

- To exit the operation, press  any time.

*1 If "ON" is selected, "↪" is displayed.

◆◆ Other Options

Changing Handset PIN

The factory preset is 0000. **Once you have programmed the handset PIN, you cannot confirm it. We recommend you write down the handset PIN. If you forget it, please consult your nearest Panasonic Service Centre.**



Press **MENU**.



Search/Select

"Setting Handset".



Search/Select

"Other Option".



Search/Select

"Change Hset PIN".

5 Current 4-digit Handset PIN

6 New 4-digit Handset PIN 7 New 4-digit Handset PIN again to verify

- To exit the operation, press  any time.

◆◆ Key Lock

You can lock the handset dialling buttons. Only incoming calls are accepted while the key lock is on. The key lock is cancelled when the handset is turned off.

When the key lock is on, emergency calls cannot be made until key lock is cancelled.

Key Lock On



Press **OK** for more than 2 seconds.

Key Lock Off



Press **OK** for more than 2 seconds.

- " [X] " is displayed and all dialling buttons are locked.

◆◆ Recall Feature

RECALL is used to access special telephone services. Contact your Network provider for details. If your unit is connected to a PBX, pressing **RECALL** allows you to access some features of your host PBX such as transferring an extension call.

◆◆ Dialling Pause (for PBX line/long distance service users)

A dialling pause is used when a pause in the dialling of the phone number is necessary using a PBX or accessing a long distance service.

EXAMPLE; When 9 (line access number) is dialled followed by a pause to access an outside line through a PBX:



- Entering a pause prevents misdialling when you redial or dial a stored number.
- Pressing **PAUSE** once creates one pause. To extend the pause requirement time, press **PAUSE** accordingly.

*1 "P" is displayed on the LCD.

*2 You can also press **SPEAKERPHONE** to make a call.

Base Unit Settings

Before programming, please follow steps 1 to 2.



Press **MENU**.



Search/Select
"Setting Base".

▶ "Input Command"



Changing Base Unit PIN

The factory preset is 0000. **Once you have programmed the base unit PIN, you cannot confirm it. We recommend you write down the base unit PIN. If you forget it, please consult your nearest Panasonic Service Centre.**

3  4 Current 4-digit Base Unit PIN 5 New 4-digit Base Unit PIN
6 New 4-digit Base Unit PIN again to verify

Call Restriction



You can restrict selected handset(s) from dialling selected phone numbers. You can assign up to 10 call restriction numbers (up to 8 digits). If you dial a restricted number, the call does not connect and the restricted number flashes.

3  4 4-digit Base Unit PIN*1 5 Handset Number 6  Press **RIGHT**.
Select desired handset.*2

7 Phone Number 8  Press **RIGHT**.
Enter phone number to be restricted.
(up to 8 digits)

9  Press **OFF**.
OR
To continue entering call restriction numbers, repeat steps 7 and 8.
(up to 10 numbers)

Cancelling Call Restricted Handset(s)

3  4 4-digit Base Unit PIN*1 5 Handset Number 6  Press **RIGHT**. 7  Press **OFF**.
Select desired handset.*3

• To exit the operation, press  any time.

*1 The factory preset is 0000.

*2 The selected handset number flashes.

*3 The selected handset(s) will stop flashing.

Base Unit Settings

Before programming, please follow steps 1 to 2.

- 1**  Press **MENU**.
- 2**  Search/Select
"Setting Base".
- "Input Command"

Canceling Call Restricted Number

3  **4** 4-digit Base Unit PIN*1

5  Press **RIGHT** repeatedly until desired call restriction number is displayed.

6  Press **CLEAR**.

7  Press **RIGHT**.





8 <to continue> OR <to finish>
Repeat the steps 5 to 7.

 Press **OFF**.

Selecting the Flash Timing

You can select the flash timing, 100 msec (milliseconds), or 600 msec depending on your PBX requirements.

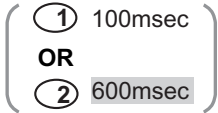
3  **4** 4-digit Base Unit PIN*1



5  **6**  **7**  **8**  Press **OK**.

① 100msec
OR
② 600msec

Pause Timing

You can set the pause time to 3 or 5 seconds, depending on your PBX requirements.

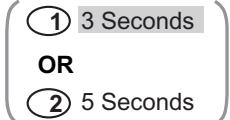
3  **4** 4-digit Base Unit PIN*1

5  **6**  **7**  Press **OK**.





① 3 Seconds
OR
② 5 Seconds

- To exit the operation, press  any time.
 - The factory preset is in shade.
- *1 The factory preset is 0000.

Initial Settings

◆◆ Reset Handset Settings

You can reset all of the handset settings to their initial settings.

<p>1 </p> <p>Press MENU.</p>	<p>2 </p> <p>Search/Select "Setting Handset".</p>	<p>3 </p> <p>Search/Select "Reset Handset".</p>
<p>4 4-digit Handset PIN*1</p>	<p>5 </p> <p>Search/Select "YES" or "NO".</p>	





- To exit the operation, press  any time.

*1 The factory preset is 0000.

Handset Initial Settings

Function	Initial Setting
Time Alarm Mode	OFF
Alarm Time	Clear
Handset Ringer Volume	3
Handset External Ringer Pattern	1
Handset Internal Ringer Pattern	1
Handset Paging Tone Pattern	1
Handset Alarm Tone Pattern	1
Key Tone	ON
Call Waiting Tone	ON
Range Warning Alarm	OFF
Battery Low Alarm	ON
Standby Mode Display	Base unit number
Talk Mode Display	Length of the Call
Display Language	English
Call Bar	OFF
Direct Call Mode	OFF
Direct Call Number	Clear
4-Digit Handset PIN	0000
Auto Talk	OFF
Base Unit Access	Automatic Base Unit Access
Redial Memory	All Clear
Handset Receiver Volume	Medium
Walkie-Talkie Setting	Group

◆◆ Reset Base Unit Settings

1		2		▶ "Input Command"	3	
	Press MENU .		Search/Select "Setting Base".			
4	4-digit Base Unit PIN*1		5		Press OK .	

- To exit the operation, press  any time.

*1 The factory preset is 0000.

Base Unit Initial Settings



Function	Initial Setting
Ringer Mode	All Handsets
Number of Rings	3
Flash Timing	600 msec
Pause Timing	3 seconds
Call Restricted Handsets	All Clear
Call Restriction Numbers	All Clear
4-Digit Base Unit PIN	0000

Multi-unit User Operation









◆◆ Handset Registration to a Base Unit

Handset Registration

The handset supplied with the base unit is already registered. If an optional handset is purchased, it must be registered. Additional **KX-A145NZ** handsets are available for purchase separately. Up to 6 handsets can be registered to a single base unit. Using additional handsets allows you to have an intercom call while simultaneously conducting a call to an outside line.

Handset registration must be completed within 1 minute after pressing the  button. If over 1 minute, press  then start over again.

Charge the optional handset batteries for 7 hours before initial use.

1  Press MENU .	2  Search/Select "Setting Handset".	3  Search/Select "Registration".	▶ "Register H/set"
4  Press RIGHT .	5 Press and hold  on the Base Unit (for about 5 seconds) until the green indicator flashes. • If all registered handsets start ringing (Paging), press  to stop paging then start over again.		
6  Search/Select desired base unit number available to register the handset.	7 4-digit Base Unit PIN after "Enter Base PIN" is displayed.*1	8  Press OK .	▶ When a handset is registered successfully, a confirmation tone sounds and the  icon lights.







• To exit the operation, press  any time.

*1 The factory preset is 0000.

Multi-unit User Operation

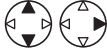
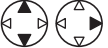



Canceling a Base Unit

You can cancel any base unit that your handset is registered to.

1  Press MENU .	2  Search/Select "Setting Handset".	3  Search/Select "Registration".
4  Search/Select "Cancel Base".	5 4-digit Handset PIN*1	6  Search/Select desired base unit number to cancel.*2
7  Press RIGHT .	8  Search/Select "YES" or "NO".	

Canceling a Handset





Each handset can cancel itself or another handset.

1  Press MENU .	2  → "Input Command"	3 
4 4-digit Base Unit PIN*1	5 Handset Number Select desired handset.*3	6  → Please wait until "Setting Base" is displayed.



- To exit the operation, press  any time.
- *1 The factory preset is 0000.
- *2 The selected base unit(s) is(are) marked with "✓".
- *3 The selected handset number flashes.

Multi-unit User Operation



Before programming, please follow steps 1 to 4.

- 1  Press MENU.
- 2  Search/Select "Setting Base".
- 3  "Input Command"
- 4  4-digit Base Unit PIN*1

Ringer Mode Selection; Setting the All Handsets Mode



- 5  All handsets mode
- 6  Press OK.



Setting the Selected Handsets Mode

- 5  Selected handsets mode
- 6 Handset Numbers*2 Press desired handset numbers.
- 7  Press OK.

Setting the Selected then All Handsets Mode

The specific handset(s) will ring for a selected number of rings.
If not answered, all handsets will ring.



- 5  Selected then all handsets mode
- 6 Handset Numbers*2 Press desired handset numbers.
- 7  Press RIGHT.
- 8 Number of Rings*3 Select how many times it rings. (up to 6 rings)
- 9  Press OK.

- To exit the operation, press  any time.
 - The factory preset is in shade.
- *1 The factory preset is 0000.
- *2 The selected handset number flashes.
- *3 Press dialling button  through  to enter the number of rings.

Multi-unit User Operation

◆◆ Base Unit Selection

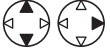
When Automatic Base Unit Access is selected, the handset automatically searches for other registered bases if you move outside of the radio range of the current base unit. When a specified base unit is selected, the handset will access that base unit only. Calls (both incoming and outgoing) can be conducted only via the selected base unit, even if the radio cells overlap with neighbouring base units.

1		2		3		4	
Press MENU .		Search/Select "Setting Handset".		Search/Select "Select Base".		Search/Select "Auto" or specific base unit number.	

- To exit the operation, press  any time.
- Even if "Auto" is selected, it is cancelled when the handset is registered to the other base unit.

Operating Additional Base Units: You can register and operate your handset with up to 4 base units. Each base unit forms 1 radio cell. If the individual bases are linked to the same telephone line then you can extend the operating range of the system by positioning the bases so that the two radio cells overlap. If the handset is set to AUTO base selection, then in standby mode the handset will automatically swap to the second base if the range on the first base is exceeded. It is not possible to transfer calls between bases (only between handsets linked to the same base unit).

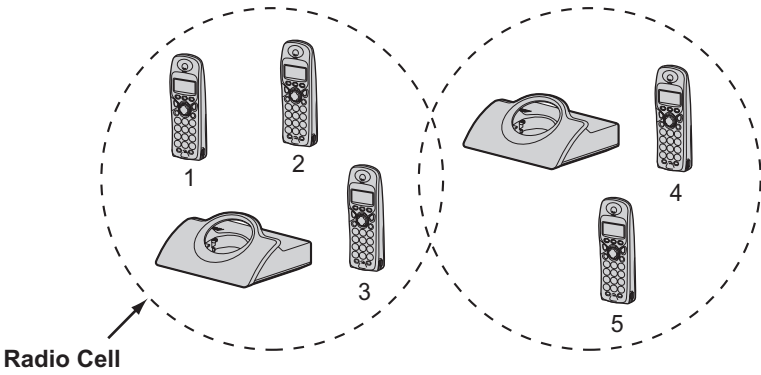

Example:
Additional
handsets
(KX-A145NZ)
registered with
2 base units.

Note: Calls are disconnected when the handset moves from one radio cell to another.

Cordless Telephone

Intercom

Intercom between Handsets

You can use your handsets as a 2-way intercom.

For example, when Handset 1 calls Handset 2:

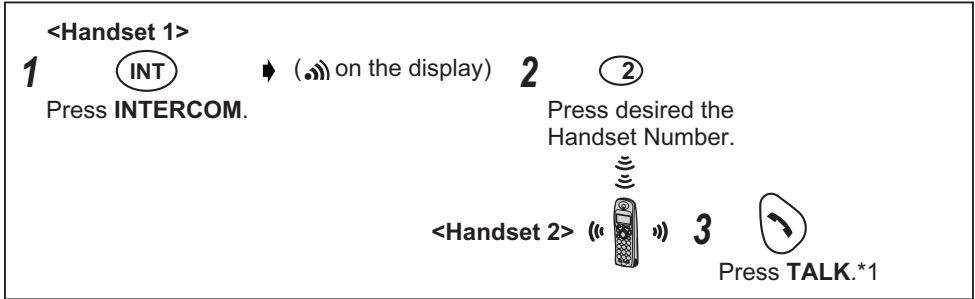

- To hang up, press .
- Intercom calls can be conducted within the radio cell of the current base unit, but not with units in neighbouring radio cells.

Transferring a Call to Another Handset/Conference Call

Intercom can be used during a call to transfer an external call between handsets that are registered to the same base unit. For example, when handset 1 transfers a call to Handset 2:

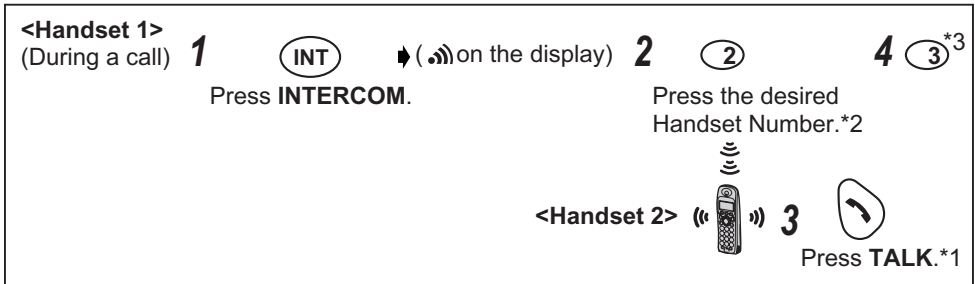

- To hang up, press .

*1 You can also press a dialling button, **INTERCOM**, **#**, ***X** or **SPEAKERPHONE**.

*2 If you press after pressing the desired handset number, a call can be transferred to another handset without speaking to another handset.

If the transferred call is not answered within 30 seconds, Handset 1 will ring again.

*3 When Handset 2 answers a call transferred, press to complete a call transfer or press dialling button **3** to establish a conference call.

The Walkie-Talkie feature allows handsets to communicate with each other outside the range of the base unit. When the handsets are in Walkie-Talkie mode, external calls cannot be received. Only KX-A145NZ handset with Walkie-Talkie feature can communicate with one another. Talk time in this mode is approximately 6 hours.

Range:

The maximum range between two handsets whilst in Walkie-Talkie mode is up to 50 metres indoors and 300 metres outdoors.

◆◆ Set the Walkie-Talkie Mode

You can set the Walkie-Talkie mode. There are two types. Common Base Station mode and Group mode. The factory preset is Group mode.

- In Common Base Station mode, communication is possible between handsets registered to a common base unit. If the handsets are registered to more than one base unit, the same base unit must be selected.

Please note, the feature will not operate if AUTO is set in the base unit selection.

If Common mode is selected and the handset is not registered to a base unit, an error tone sounds.

- In Group mode, communication is possible between handsets that are both set to this mode and whose Group ID's are common.

This allows the handsets not to be dependent upon the base unit to which they are registered and can operate outside of the base unit range.

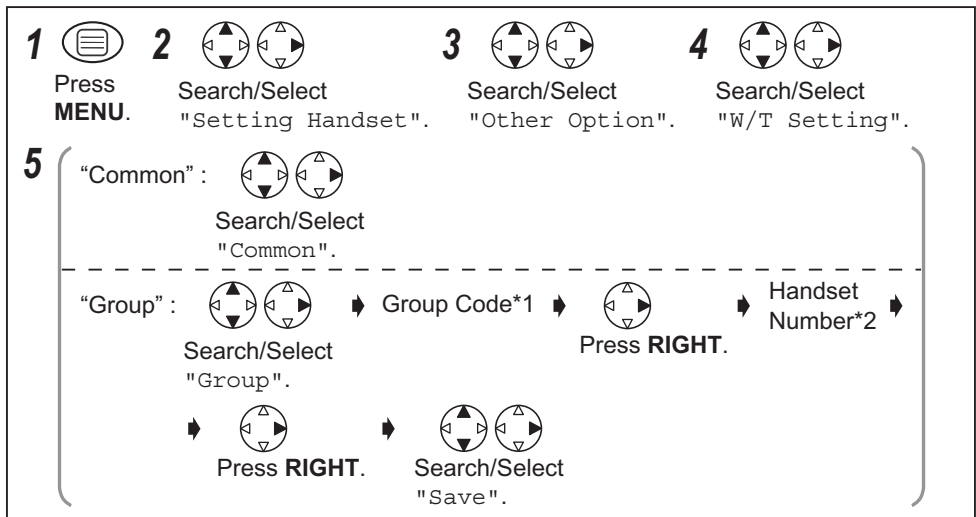

- To exit the operation, press any time.

*1 This can be 3 numbers of your choice. The default is 000. Make note of your code.



*2 The default is 1.

IMPORTANT: Each handset should have its own unique number.

Walkie-Talkie

◆◆ To turn the Walkie-Talkie Mode ON/OFF

To use the Walkie-Talkie feature, all handsets in conversation must be in Walkie-Talkie mode.

1  Press MENU .	2  Search/Select "Walkie-Talkie".	3  Search/Select "ON" or "OFF".*1
---	---	---







- To exit the operation, press  any time.

*1 When the Walkie-Talkie mode is ON, the handset number is displayed after "Walkie-Talkie" in the first line of the display.

◆◆ Talking in Walkie-Talkie Mode

Before proceeding with this function, please ensure Walkie-Talkie mode is turned on, and the appropriate Walkie-Talkie mode has been selected.

For example, when Handset 1 is calling Handset 2:

<Handset 1>		
1  Press INTERCOM .		2  Press desired handset number.*1
OR		
 Press TALK .		
OR		
 Press SPEAKERPHONE .	<Handset 2> 	3  Press TALK .*2

- To hang up, press .

- You can press **UP** or **DOWN** to adjust the volume while in Walkie-Talkie mode.

*1 The sender can input  as a remote internal number. In this case all handsets in the same Walkie-Talkie mode are called.

*2 You can also press a dialling button, **INTERCOM**, **#**,  or **SPEAKERPHONE**.

Using the Belt Clip

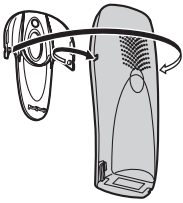

To remove the belt clip.

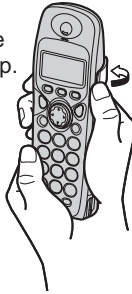

You can hang the handset on your belt or pocket using the belt clip.

Optional Headset

Plugging the optional headset into the handset allows hands-free phone conversations. Please use only the Panasonic KX-TCA88AL headset.

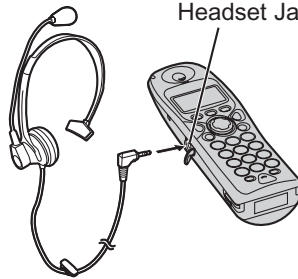

Headset Jack

Connecting the optional headset to the handset

Open the headset jack cover, and connect the optional headset to the headset jack as shown.

Wall Mounting

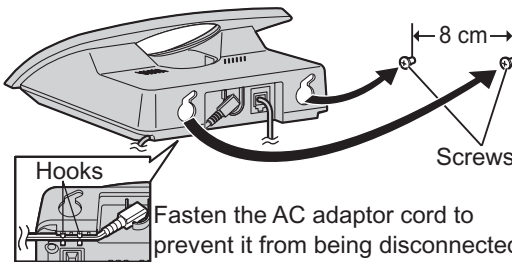

Fasten the AC adaptor cord to prevent it from being disconnected.

This unit can be mounted on a wall.

- Insert screws into the wall. The centre of the screw holes should be 8 cm horizontally apart.
- Connect the AC adaptor and the telephone line cord.
- Arrange the wires as shown, then mount the unit.

Wall Template

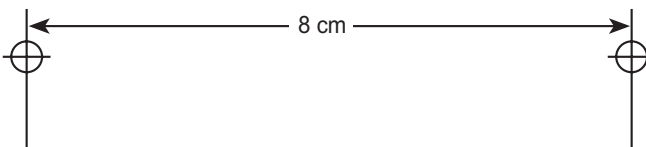

Before Requesting Help



If you experience any problems with the normal use of your apparatus, you should unplug it from the telephone outlet and connect a known working telephone in its place. If the known working telephone still has problems, then please contact the customer service department of your Network provider.

If it operates correctly, then the problem is likely to be a fault in your apparatus. In this case, contact your supplier for advice. Your Network provider may charge you if they attend a service call that is not due to an apparatus supplied by them.

Turn the power OFF then ON (Handset)/Disconnect then connect the AC adaptor (Base Unit).

Problem	Possible cause	Solution
Display is blank.	<ul style="list-style-type: none">• Handset not turned on.	<ul style="list-style-type: none">• Turn on power (p. 8).
Handset will not turn on.	<ul style="list-style-type: none">• Batteries not inserted.• Batteries not charged.	<ul style="list-style-type: none">• Insert the 2 rechargeable batteries supplied (p. 4).• Place handset on base and connect AC adaptor to base and AC outlet (full charge period 7 hrs).
Battery charge icon not counting up.	<ul style="list-style-type: none">• Dirty charge contact.• Base not powered up.	<ul style="list-style-type: none">• Clean charge/battery contact and retry charge.• Connect AC adaptor to base unit and AC outlet.
Y icon flashes.	<ul style="list-style-type: none">• Handset not registered to base.• Handset out of range of base.• No power into base unit.	<ul style="list-style-type: none">• Register handset to base.• Move handset closer to base.• Connect AC adaptor to base unit and AC outlet.
Handset busy tone heard when  is pressed.	<ul style="list-style-type: none">• Handset out of range of base.• Another handset in use.	<ul style="list-style-type: none">• Move handset closer to base.• Wait for the other user to complete call.
No dial tone.	<ul style="list-style-type: none">• Telephone line not connected.	<ul style="list-style-type: none">• Insert telephone cord to network.• Turn power OFF then ON.
Cannot dial out.	<ul style="list-style-type: none">• Call Bar set.• Particular dialled number is restricted.• Key lock mode ON.	<ul style="list-style-type: none">• Turn feature off.• Remove number from call restricted list.• Turn key lock OFF.
Handset will not ring.	<ul style="list-style-type: none">• Ringer switched off.	<ul style="list-style-type: none">• Set ringer to one of 6 volume levels.

Before Requesting Help

Problem	Possible cause	Solution
Last number redial does not work.	<ul style="list-style-type: none">• Number exceeded 24 digits.	<ul style="list-style-type: none">• Redial manually.
No Caller ID number displayed.	<ul style="list-style-type: none">• Service not supplied.• Caller has withheld info.	<ul style="list-style-type: none">• Caller ID service must be arranged with Network provider.
 icon flashes.	<ul style="list-style-type: none">• Battery low.	<ul style="list-style-type: none">• Recharge batteries.
 icon has disappeared.	<ul style="list-style-type: none">• Wrong battery type selected.	<ul style="list-style-type: none">• Set the correct battery type.
Cannot register handset to base.	<ul style="list-style-type: none">• Max. number of bases already registered to handset.• Max. number of handsets already registered to base unit.• Wrong PIN number entered (Default 0000).• Electrical noise in local area.	<ul style="list-style-type: none">• Delete unused base registrations from handset.• Delete unused handset registrations from base.• If PIN number is lost, contact the Panasonic Service Centre.• Move base/handset away from sources of electrical noise (TVs, radios, etc.).

Technical Information

Specifications

Standard:	DECT=(<u>D</u> igital <u>E</u> nhanced <u>C</u> ordless <u>T</u> elecommunications) GAP=(<u>G</u> eneric <u>A</u> ccess <u>P</u> rofile)
Number of channels:	120 Duplex Channels
Frequency range:	1.88 GHz to 1.9 GHz
Duplex procedure:	TDMA (Time Division Multiple Access)
Channel spacing:	1728 kHz
Bit rate:	1152 kbit/s
Modulation:	GFSK
RF Transmission Power:	approx. 250 mW
Voice coding:	ADPCM 32 kbit/s
Power source:	AC Adaptor 220 - 240 V, 50 Hz
Power consumption, base unit:	5 VA
Operating conditions:	5 - 40 °C, 20 - 80 % relative air humidity (dry)
Dimensions, Base Unit:	About (58 mm x 128 mm x 105 mm) x 170 g
Dimensions, Handset:	About (143 mm x 48 mm x 32 mm) x 120 g

- Specifications are subject to change.
- The illustrations used in this manual may differ slightly from the original device.

Connections:

The unit will not work during a power failure. We recommend you connect a standard telephone on the same line for power protection.

AC Adaptor	2, 4
Accessories	2
Auto Talk	9
Base Unit	
Initial Settings	33
PIN	30
Reset	33
Selection	37
Battery	
Caution	3
Charge	5
Installation	4
Life	5
Battery Low Alarm	26
Belt Clip	41
Call Restriction	
Cancelling Call Restricted	
Handset(s)	30
Cancelling Call Restricted Number ...	31
Call Waiting	12
Caller ID List	
Calling Back	14
Clearing	15
Editing	14
Storing	21
Calls	
Answering	9
Making	8, 11
Redialling	11
Terminating	9
Cancelling a Base Unit	35
Cancelling a Handset	35
Clock/Date	8
Conference Call	38
Dialling Pause	29
Direct Call Number	28
Display	
Standby Mode	26
Talk Mode	27
Flash Timing	31
Handset	
Display	7
Initial Settings	32
Locator	10
Paging	10
PIN	28
Registration	34
Reset	32
Ringer	25
Headset, optional	41
Intercom	38
Key	
Lock	29
Tone	26
Making Calls	
Calling Back	14
Redialling	11
with the Phonebook	20
Phonebook	
Hot Key	22
Storing	16, 21
Power On/Off	8
Range Warning Alarm	26
Recall	29
Receiver Volume	9
Ringer Pattern	25
Ringer Volume	25
Setting up	4
Speakerphone	10
Specifications	44
Time Alarm	24
Tone Option	26
Walkie-Talkie	39
Wall Mounting	41

For your future reference

Serial No.

Date of purchase

(found on the bottom of the unit)

Name and address of dealer

Technical specifications are subject to change.

Sales Department:

Panasonic New Zealand Ltd
350 Te Irirangi Drive
East Tamaki
Private Bag 14911
Panmure AUCKLAND
NEW ZEALAND

Panasonic Communications Co., Ltd.

1-62, 4-chome, Minoshima, Hakata-ku, Fukuoka 812-8531, Japan