

### Video Distribution Amplifier

The 5962-0721201QXC is a fully DSCC SMD compliant parts and the SMD data sheets is available on the DSCC website (<http://www.dsccl.dla.mil/programs/specfind/default.asp>). The 5962-0721201QXC is electrically equivalent to the EL8108. Reference equivalent "EL8108" data sheet for additional information. The 5962-0721201QXC is a dual current feedback operational amplifier designed for video distribution solutions. This device features a high drive capability of 450mA while consuming 13mA of supply current per amplifier and operating from a single 5V to 12V supply.

The 5962-0721201QXC is available in the industry standard 10 Ld Flatpack. The 5962-0721201QXC is ideal for driving multiple video loads while maintaining linearity.

### Ordering Information

PART NUMBER	PART MARKING	PACKAGE	PKG. DWG. #
5962-0721201QXC	07212 01QHC	10 Ld Flat Pack	K10.A

TABLE 1.

150Ω	150Ω	DIFF GAIN	DIFF PHASE
1	0	0.03	0.01
1	1	0.03	0.01
2	1	0.05	0.02
2	2	0.06	0.03
3	2	0.08	0.03
3	3	0.11	0.03
2	0	0.04	0.01
3	0	0.05	0.02
4	0	0.07	0.02
5	0	0.08	0.03
6	0	0.10	0.03

### Features

- Drives up to 450mA from a +12V supply
- 20V<sub>P-P</sub> differential output drive into 100Ω
- -85dBc typical driver output distortion at full output at 150kHz
- -70dBc typical driver output distortion at 3.75MHz
- Low quiescent current of 13mA per amplifier
- 300MHz bandwidth

### Applications

- Video distribution amplifiers

### Pinout

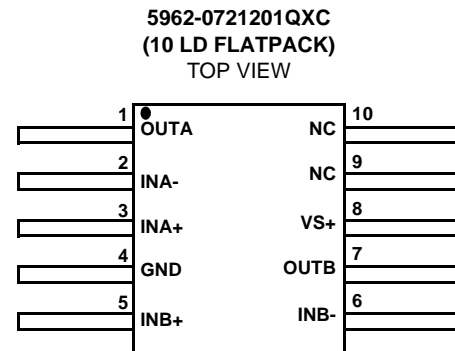

**Absolute Maximum Ratings** ( $T_A = +25^\circ\text{C}$ )

$V_{S+}$ Voltage to Ground	-0.3V to +13.2V
$V_{IN+}$ Voltage	GND to $V_{S+}$
Current into any Input	8mA
Continuous Output Current	60mA

**Thermal Information**

Thermal Resistance (Typical)	$\theta_{JA}$ ( $^\circ\text{C}/\text{W}$ )
10 Lead Flatpack	177
Ambient Operating Temperature Range	-55 $^\circ\text{C}$ to +125 $^\circ\text{C}$
Storage Temperature Range	-60 $^\circ\text{C}$ to +150 $^\circ\text{C}$
Operating Junction Temperature	+150 $^\circ\text{C}$

*CAUTION: Do not operate at or near the maximum ratings listed for extended periods of time. Exposure to such conditions may adversely impact product reliability and result in failures not covered by warranty.*

*IMPORTANT NOTE: All parameters having Min/Max specifications are guaranteed. Typical values are for information purposes only. Unless otherwise noted, all tests are at the specified temperature and are pulsed tests, therefore:  $T_J = T_C = T_A$*

**Electrical Specifications**  $V_S = 12\text{V}$ ,  $R_F = 750\Omega$ ,  $R_L = 100\Omega$  connected to mid supply,  $T_A = +25^\circ\text{C}$ , unless otherwise specified.

PARAMETER	DESCRIPTION	CONDITIONS	MIN	TYP	MAX	UNIT
<b>AC PERFORMANCE</b>						
BW	-3dB Bandwidth	$R_F = 500\Omega$ , $A_V = +2$		200		MHz
		$R_F = 500\Omega$ , $A_V = +4$		150		MHz
HD	Total Harmonic Distortion, Differential	$f = 200\text{kHz}$ , $V_O = 16\text{V}_{P-P}$ , $R_L = 50\Omega$		-83		dBc
		$f = 4\text{MHz}$ , $V_O = 2\text{V}_{P-P}$ , $R_L = 100\Omega$		-70		dBc
		$f = 8\text{MHz}$ , $V_O = 2\text{V}_{P-P}$ , $R_L = 100\Omega$		-60		dBc
		$f = 16\text{MHz}$ , $V_O = 2\text{V}_{P-P}$ , $R_L = 100\Omega$		-50		dBc
SR	Slew Rate, Single-ended	$V_{OUT}$ from -3V to +3V		800		V/ $\mu\text{s}$
<b>INPUT CHARACTERISTICS</b>						
$e_N$	Input Noise Voltage			6		nV/ $\sqrt{\text{Hz}}$
$i_N$	-Input Noise Current			13		pA/ $\sqrt{\text{Hz}}$
<b>OUTPUT CHARACTERISTICS</b>						
$I_{OUT}$	Output Current	$R_L = 0\Omega$		450		mA

**Typical Performance Curves**

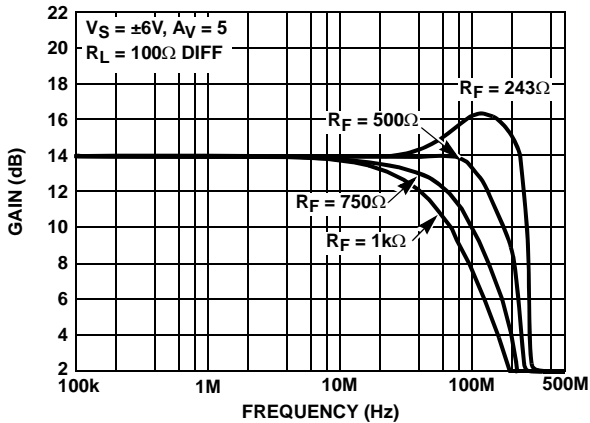

FIGURE 1. DIFFERENTIAL FREQUENCY RESPONSE WITH VARIOUS  $R_F$  (FULL POWER MODE)

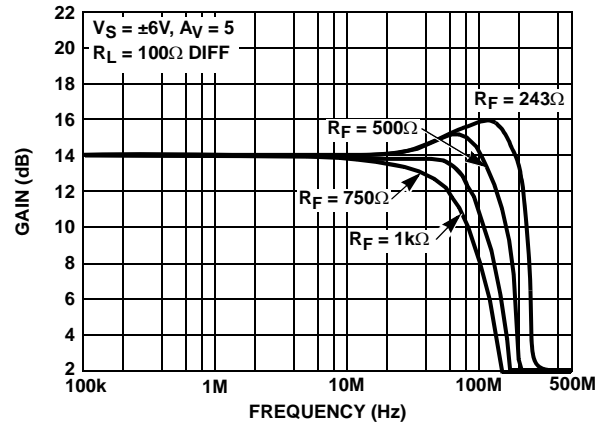

FIGURE 2. DIFFERENTIAL FREQUENCY RESPONSE WITH VARIOUS  $R_F$  (3/4 POWER MODE)

Typical Performance Curves (Continued)

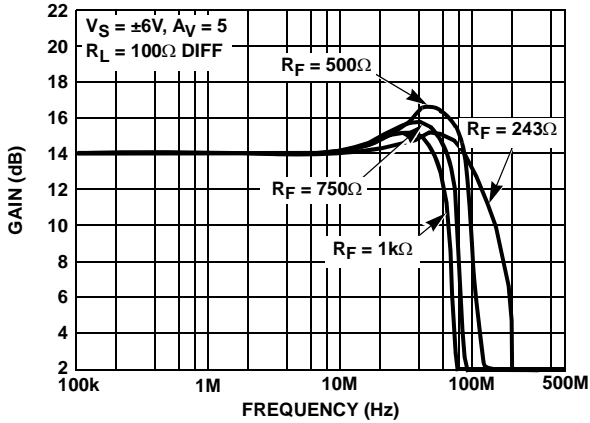

FIGURE 3. DIFFERENTIAL FREQUENCY RESPONSE WITH VARIOUS  $R_F$  (1/2 POWER MODE)

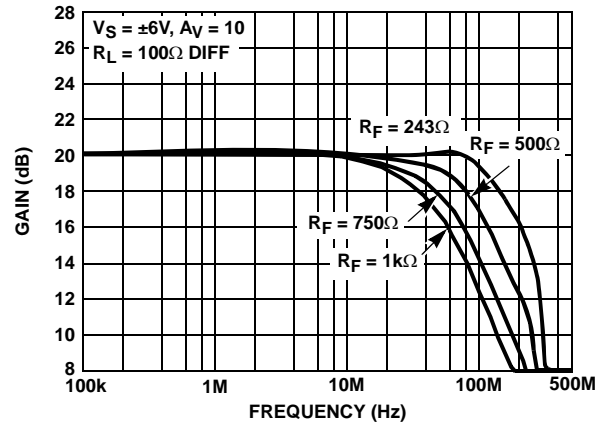

FIGURE 4. DIFFERENTIAL FREQUENCY RESPONSE WITH VARIOUS  $R_F$  (FULL POWER MODE)

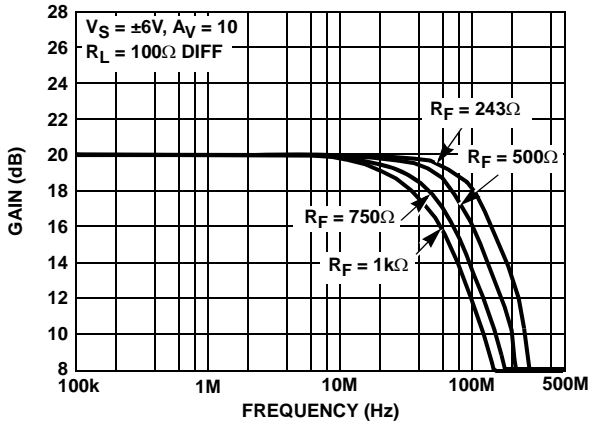

FIGURE 5. DIFFERENTIAL FREQUENCY RESPONSE WITH VARIOUS  $R_F$  (3/4 POWER MODE)

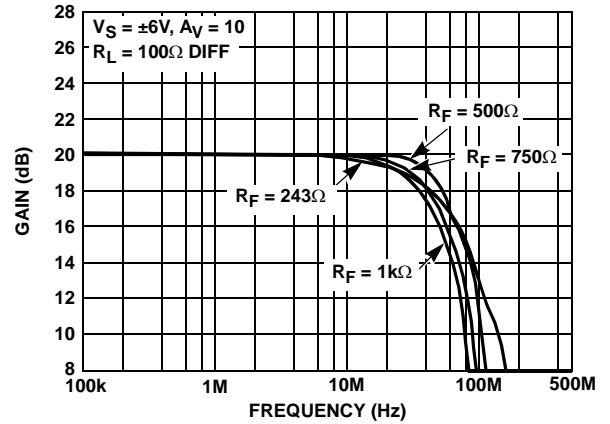

FIGURE 6. DIFFERENTIAL FREQUENCY RESPONSE WITH VARIOUS  $R_F$  (1/2 POWER MODE)

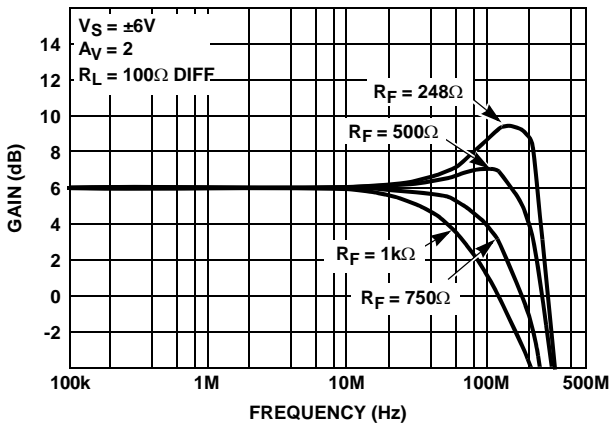

FIGURE 7. DIFFERENTIAL FREQUENCY RESPONSE WITH VARIOUS  $R_F$

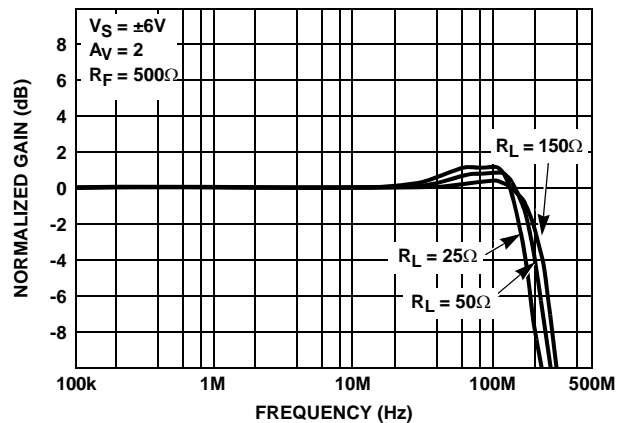

FIGURE 8. FREQUENCY RESPONSE FOR VARIOUS  $R_{LOAD}$

Typical Performance Curves (Continued)

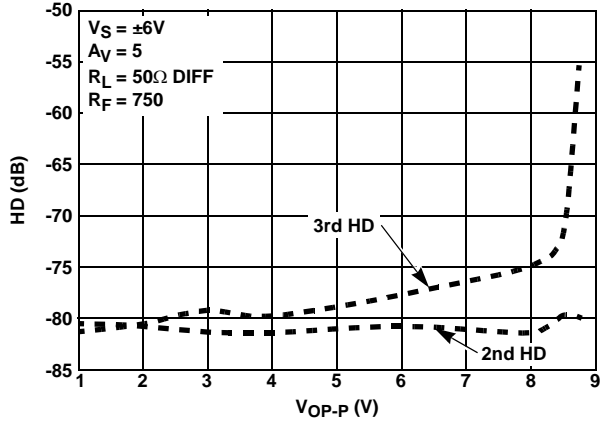

FIGURE 9. DISTORTION AT 2MHz

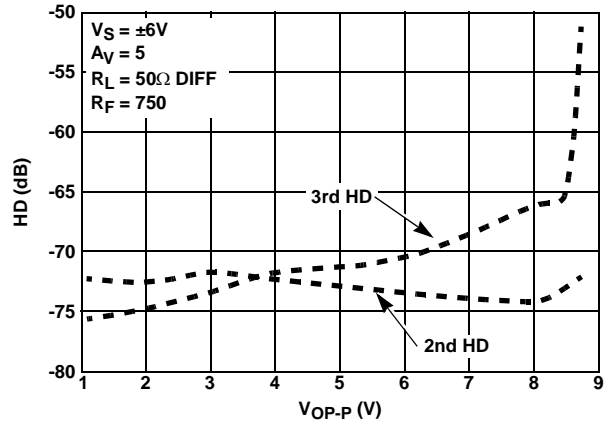

FIGURE 10. DISTORTION AT 3MHz

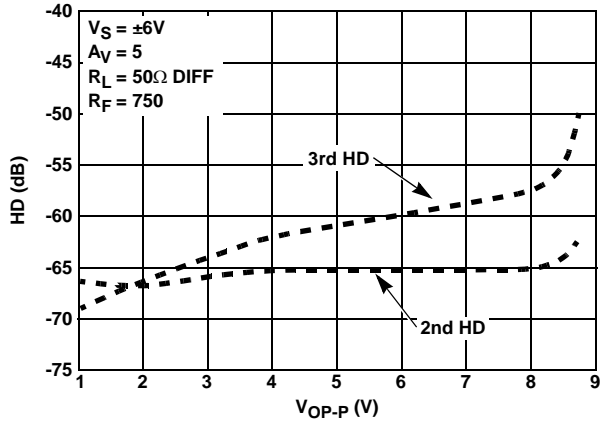

FIGURE 11. DISTORTION AT 5MHz

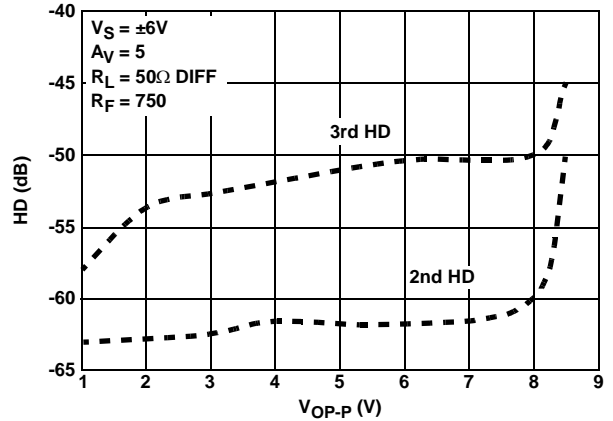

FIGURE 12. DISTORTION AT 10MHz

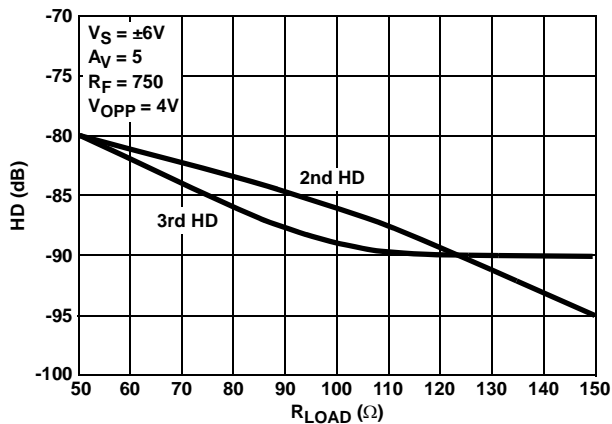

FIGURE 13. 2nd AND 3rd HARMONIC DISTORTION vs R<sub>LOAD</sub> @ 2MHz

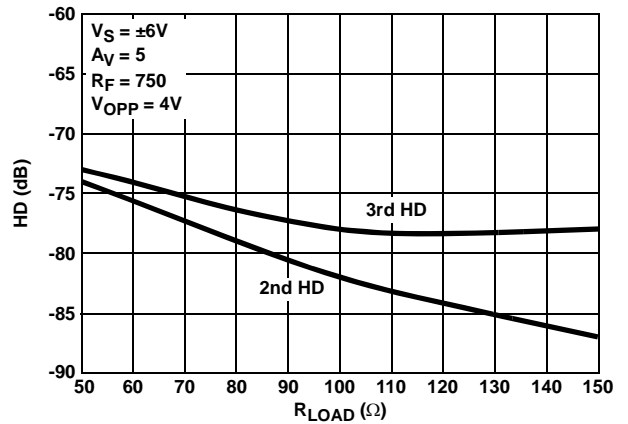

FIGURE 14. 2nd AND 3rd HARMONIC DISTORTION vs R<sub>LOAD</sub> @ 3MHz

Typical Performance Curves (Continued)

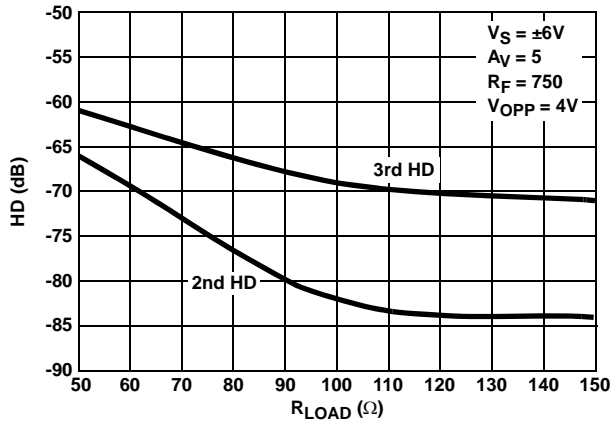

FIGURE 15. 2nd AND 3rd HARMONIC DISTORTION vs  $R_{LOAD}$  @ 5MHz

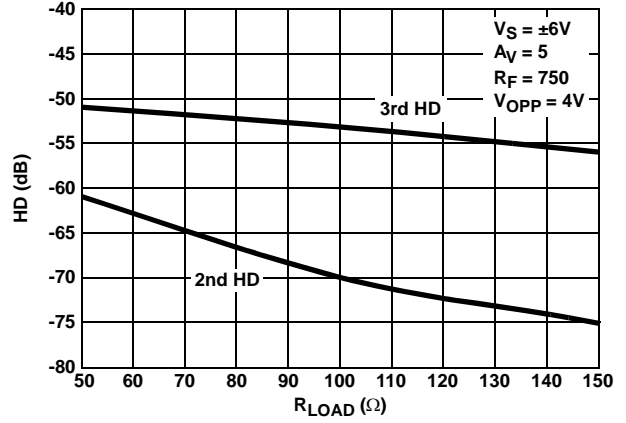

FIGURE 16. 2nd AND 3rd HARMONIC DISTORTION vs  $R_{LOAD}$  @ 10MHz

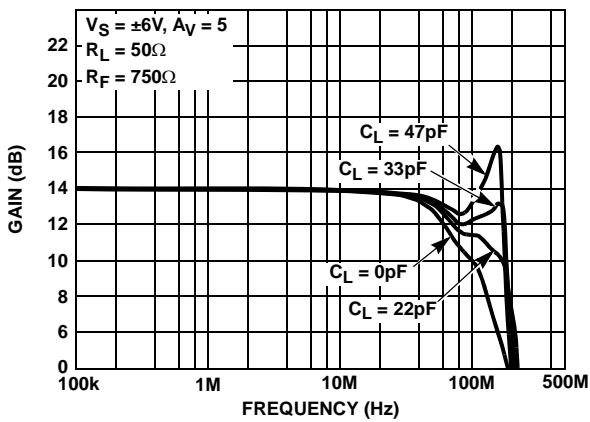

FIGURE 17. FREQUENCY RESPONSE WITH VARIOUS  $C_L$

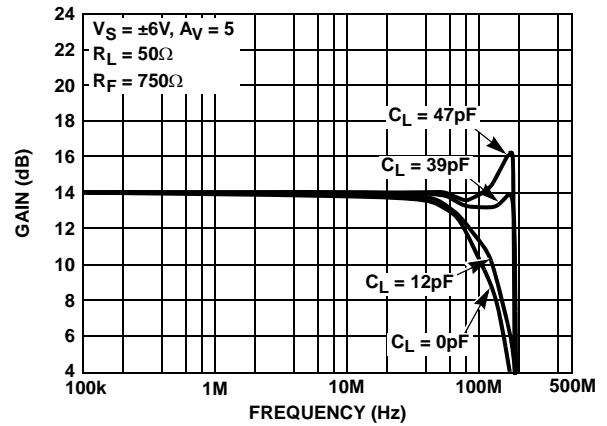

FIGURE 18. FREQUENCY RESPONSE vs VARIOUS  $C_L$  (3/4 POWER MODE)

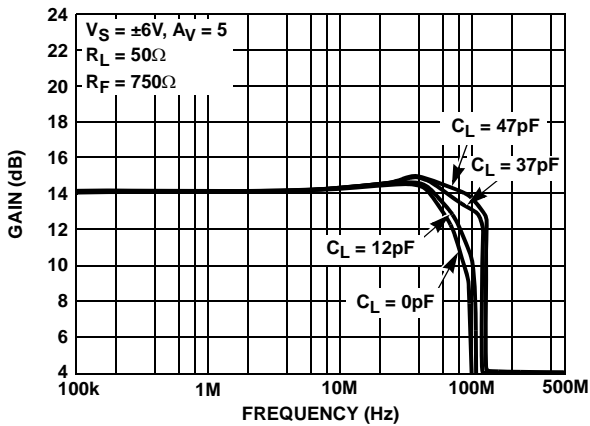

FIGURE 19. FREQUENCY RESPONSE WITH VARIOUS  $C_L$  (1/2 POWER MODE)

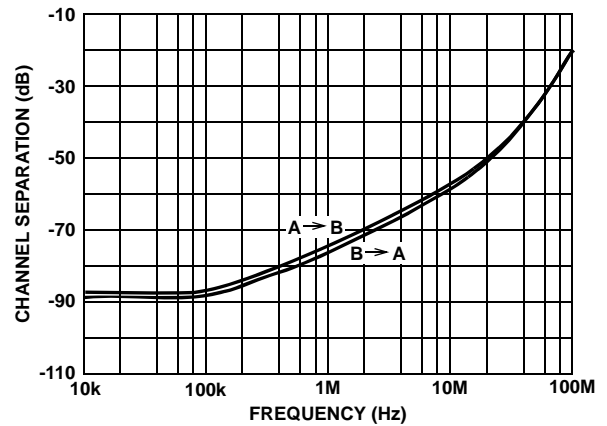

FIGURE 20. CHANNEL SEPARATION vs FREQUENCY

Typical Performance Curves (Continued)

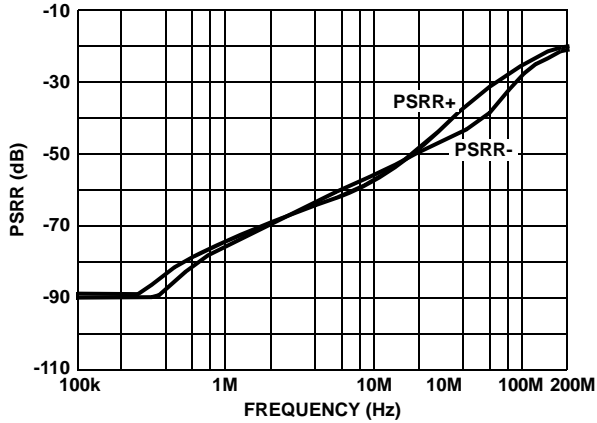

FIGURE 21. PSRR vs FREQUENCY

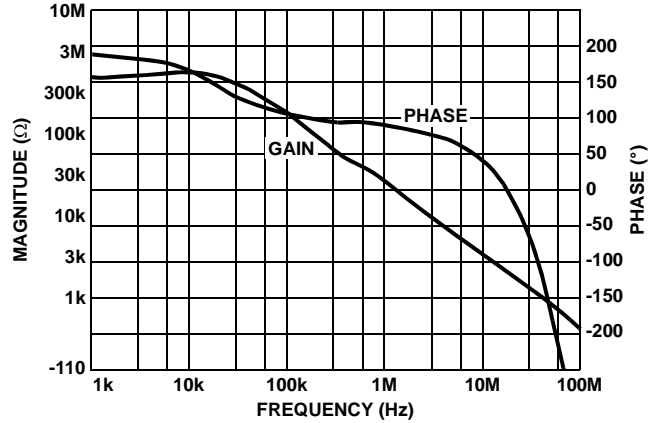

FIGURE 22. TRANSIMPEDANCE ( $R_{OL}$ ) vs FREQUENCY

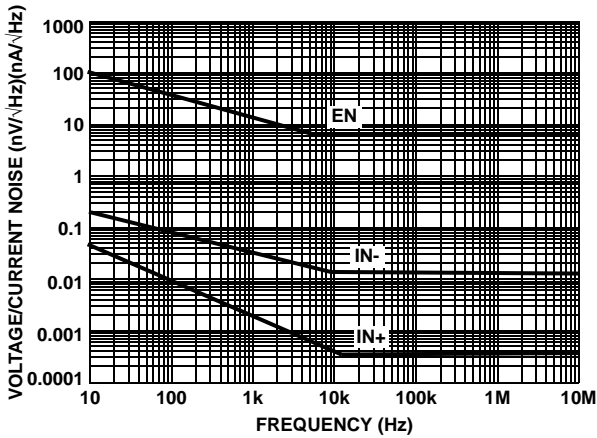

FIGURE 23. VOLTAGE AND CURRENT NOISE vs FREQUENCY

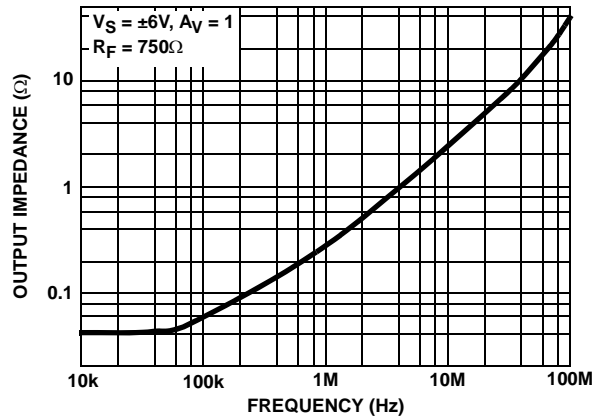

FIGURE 24. OUTPUT IMPEDANCE vs FREQUENCY

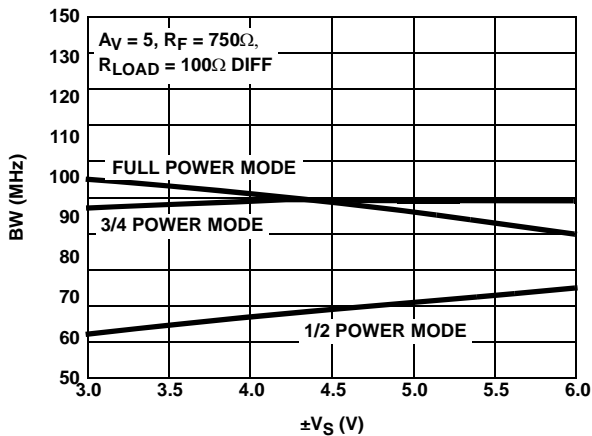

FIGURE 25. DIFFERENTIAL BANDWIDTH vs SUPPLY VOLTAGE

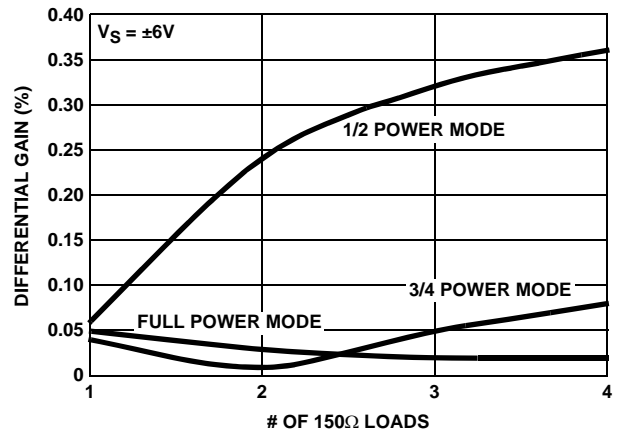

FIGURE 26. DIFFERENTIAL GAIN

Typical Performance Curves (Continued)

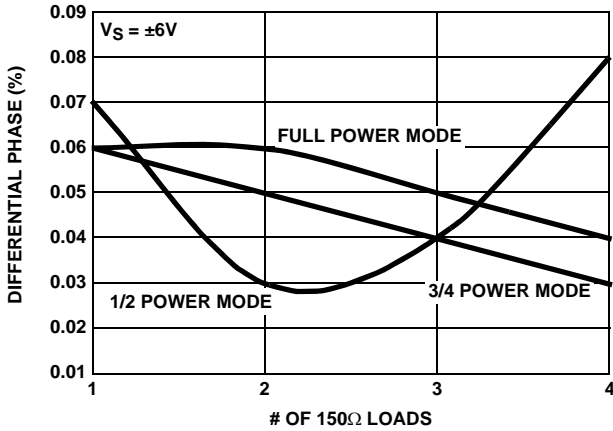

FIGURE 27. DIFFERENTIAL PHASE

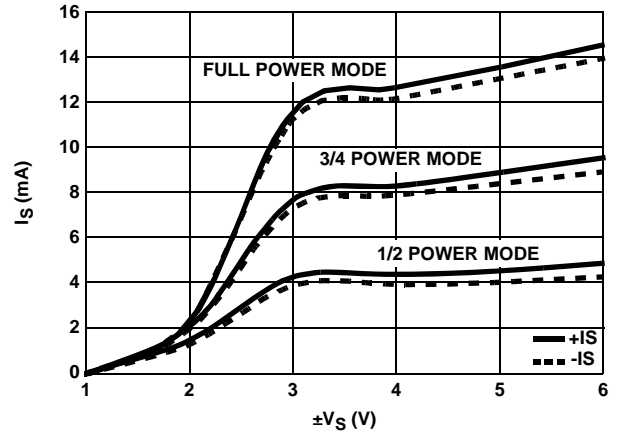

FIGURE 28. SUPPLY CURRENT vs SUPPLY VOLTAGE

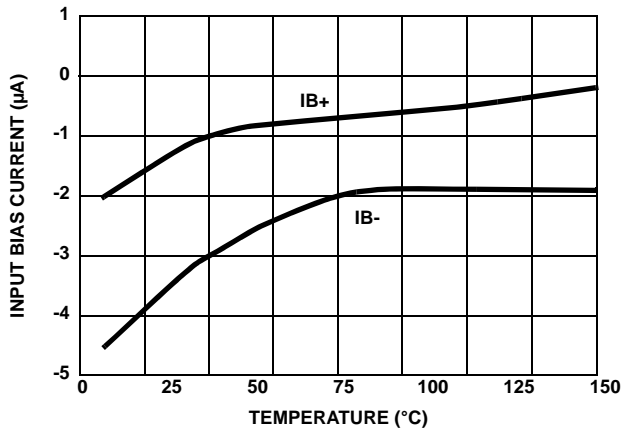

FIGURE 29. INPUT BIAS CURRENT vs TEMPERATURE

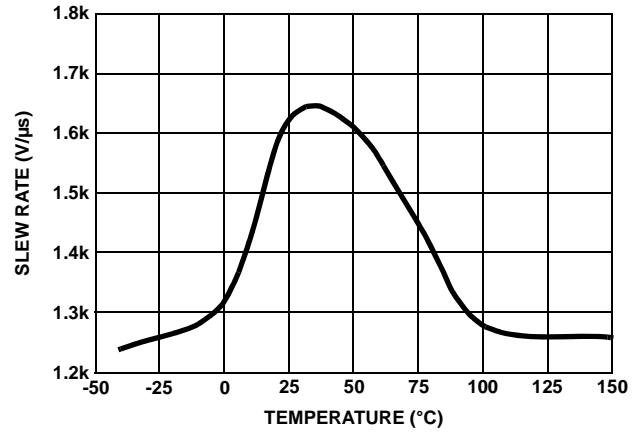

FIGURE 30. SLEW RATE vs TEMPERATURE

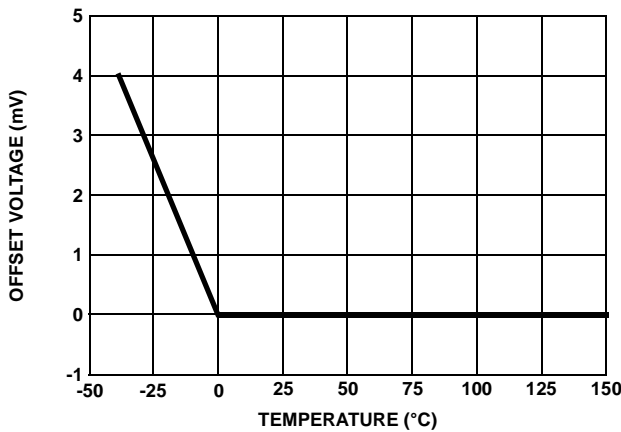

FIGURE 31. OFFSET VOLTAGE vs TEMPERATURE

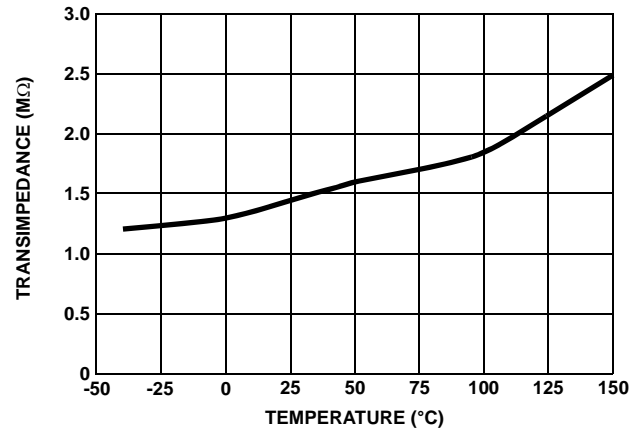

FIGURE 32. TRANSIMPEDANCE vs TEMPERATURE

## Typical Performance Curves (Continued)

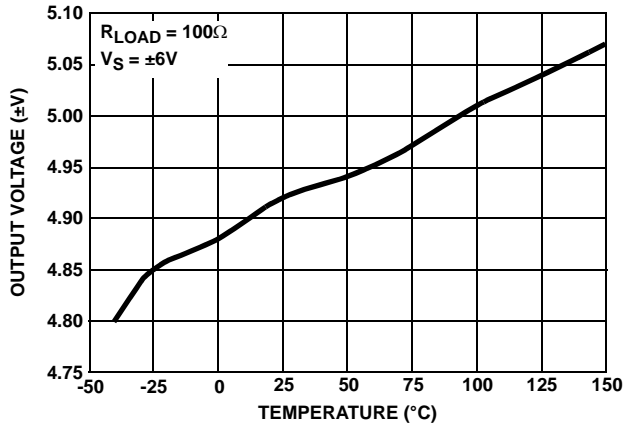

FIGURE 33. OUTPUT VOLTAGE vs TEMPERATURE

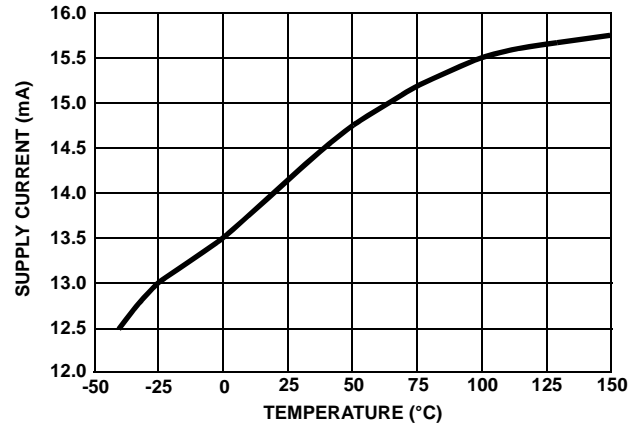

FIGURE 34. SUPPLY CURRENT vs TEMPERATURE

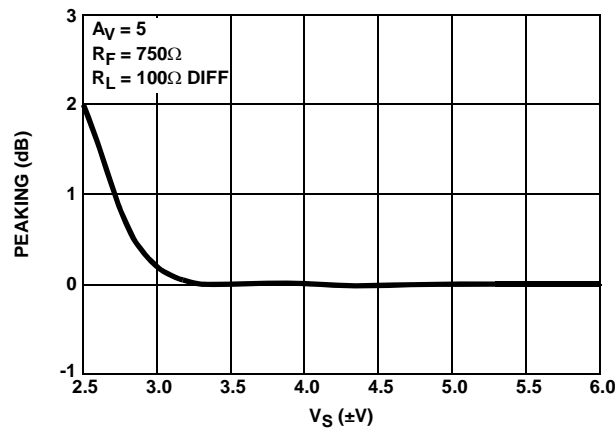

FIGURE 35. DIFFERENTIAL PEAKING vs SUPPLY VOLTAGE

## Applications Information

### Product Description

The 5962-0721201QXC is a dual current feedback operational amplifier designed for video distribution solutions. It is a dual current mode feedback amplifier with low distortion while drawing moderately low supply current. It is built using Intersil's proprietary complimentary bipolar process. Due to the current feedback architecture, the 5962-0721201QXC closed-loop 3dB bandwidth is dependent on the value of the feedback resistor. First the desired bandwidth is selected by choosing the feedback resistor,  $R_F$ , and then the gain is set by picking the gain resistor,  $R_G$ . The curves at the beginning of the Typical Performance Curves section show the effect of varying both  $R_F$  and  $R_G$ . The 3dB bandwidth is somewhat dependent on the power supply voltage.

### Power Supply Bypassing and Printed Circuit Board Layout

As with any high frequency device, good printed circuit board layout is necessary for optimum performance. Ground

plane construction is highly recommended. Lead lengths should be as short as possible, below  $\frac{1}{4}$ ". The power supply pins must be well bypassed to reduce the risk of oscillation. A  $4.7\mu\text{F}$  tantalum capacitor in parallel with a  $0.1\mu\text{F}$  ceramic capacitor is adequate for each supply pin.

For good AC performance, parasitic capacitances should be kept to a minimum, especially at the inverting input. This implies keeping the ground plane away from this pin. Carbon resistors are acceptable, while use of wire-wound resistors should not be used because of their parasitic inductance. Similarly, capacitors should be low inductance for best performance.

### Capacitance at the Inverting Input

Due to the topology of the current feedback amplifier, stray capacitance at the inverting input will affect the AC and transient performance of the 5962-0721201QXC when operating in the non-inverting configuration.

In the inverting gain mode, added capacitance at the inverting input has little effect since this point is at a virtual ground and stray capacitance is therefore not "seen" by the amplifier.



### Feedback Resistor Values

The 5962-0721201QXC has been designed and specified with  $R_F = 500\Omega$  for  $A_V = +2$ . This value of feedback resistor yields extremely flat frequency response with little to no peaking out to 200MHz. As is the case with all current feedback amplifiers, wider bandwidth, at the expense of slight peaking, can be obtained by reducing the value of the feedback resistor. Inversely, larger values of feedback resistor will cause rolloff to occur at a lower frequency. See the curves in the Typical Performance Curves section which show 3dB bandwidth and peaking vs. frequency for various feedback resistors and various supply voltages.

### Bandwidth vs Temperature

Whereas many amplifier's supply current and consequently 3dB bandwidth drop off at high temperature, the 5962-0721201QXC was designed to have little supply current variations with temperature. An immediate benefit from this is that the 3dB bandwidth does not drop off drastically with temperature.

### Supply Voltage Range

The 5962-0721201QXC has been designed to operate with supply voltages from  $\pm 2.5V$  to  $\pm 6V$ . Optimum bandwidth, slew rate, and video characteristics are obtained at higher supply voltages. However, at  $\pm 2.5V$  supplies, the 3dB bandwidth at  $A_V = +5$  is a respectable 200MHz.

### Single Supply Operation

If a single supply is desired, values from +5V to +12V can be used as long as the input common mode range is not exceeded. When using a single supply, be sure to either 1) DC bias the inputs at an appropriate common mode voltage and AC couple the signal, or 2) ensure the driving signal is within the common mode range of the 5962-0721201QXC.

### Driving Cables and Capacitive Loads

The 5962-0721201QXC was designed with driving multiple coaxial cables in mind. With 450mA of output drive and low output impedance, driving six, 75 $\Omega$  double terminated coaxial cables to  $\pm 11V$  with one 5962-0721201QXC is practical.

When used as a cable driver, double termination is always recommended for reflection-free performance. For those applications, the back termination series resistor will decouple the 5962-0721201QXC from the capacitive cable and allow extensive capacitive drive.

Other applications may have high capacitive loads without termination resistors. In these applications, an additional small value (5 $\Omega$  to 50 $\Omega$ ) resistor in series with the output will eliminate most peaking.

The schematic below shows the EL8108 driving 6 double terminated cables, each of average length of 50 feet.

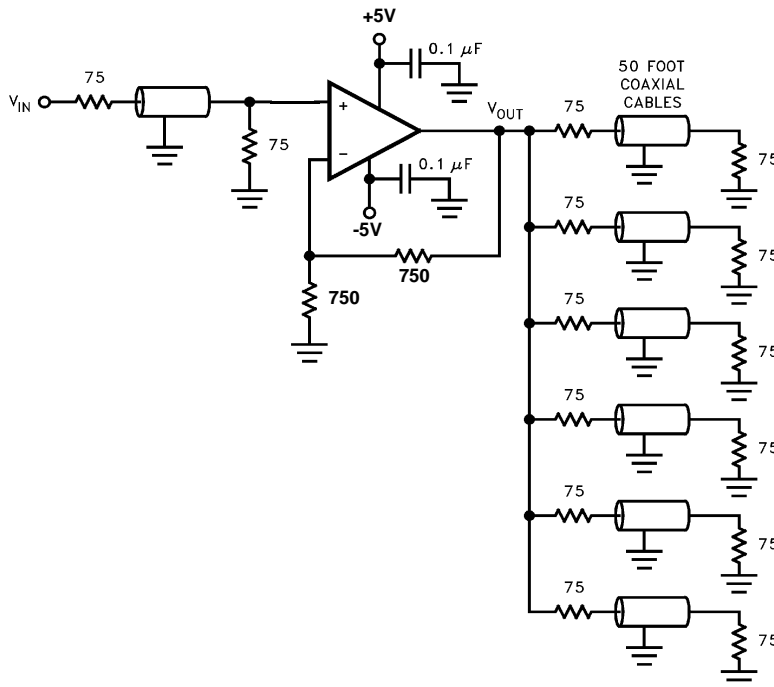

All Intersil U.S. products are manufactured, assembled and tested utilizing ISO9000 quality systems. Intersil Corporation's quality certifications can be viewed at [www.intersil.com/design/quality](http://www.intersil.com/design/quality)

*Intersil products are sold by description only. Intersil Corporation reserves the right to make changes in circuit design, software and/or specifications at any time without notice. Accordingly, the reader is cautioned to verify that data sheets are current before placing orders. Information furnished by Intersil is believed to be accurate and reliable. However, no responsibility is assumed by Intersil or its subsidiaries for its use; nor for any infringements of patents or other rights of third parties which may result from its use. No license is granted by implication or otherwise under any patent or patent rights of Intersil or its subsidiaries.*

For information regarding Intersil Corporation and its products, see [www.intersil.com](http://www.intersil.com)

**Ceramic Metal Seal Flatpack Packages (Flatpack)**

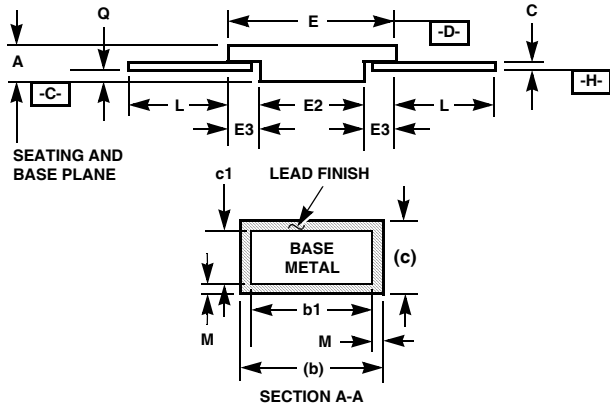
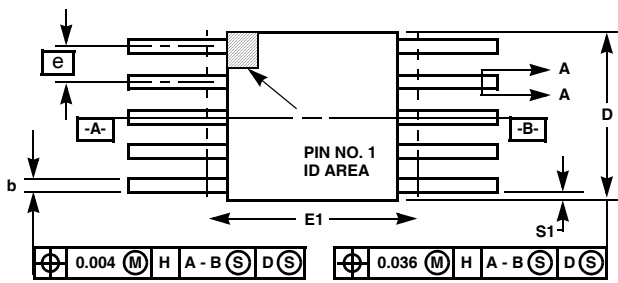

**K10.A MIL-STD-1835 CDFP3-F10 (F-4A, CONFIGURATION B)  
10 LEAD CERAMIC METAL SEAL FLATPACK PACKAGE**

SYMBOL	INCHES		MILLIMETERS		NOTES
	MIN	MAX	MIN	MAX	
A	0.045	0.115	1.14	2.92	-
b	0.015	0.022	0.38	0.56	-
b1	0.015	0.019	0.38	0.48	-
c	0.004	0.009	0.10	0.23	-
c1	0.004	0.006	0.10	0.15	-
D	-	0.290	-	7.37	3
E	0.240	0.260	6.10	6.60	-
E1	-	0.280	-	7.11	3
E2	0.125	-	3.18	-	-
E3	0.030	-	0.76	-	7
e	0.050 BSC		1.27 BSC		-
k	0.008	0.015	0.20	0.38	2
L	0.250	0.370	6.35	9.40	-
Q	0.026	0.045	0.66	1.14	8
S1	0.005	-	0.13	-	6
M	-	0.0015	-	0.04	-
N	10		10		-

Rev. 0 3/07

**NOTES:**

1. Index area: A notch or a pin one identification mark shall be located adjacent to pin one and shall be located within the shaded area shown. The manufacturer's identification shall not be used as a pin one identification mark. Alternately, a tab (dimension k) may be used to identify pin one.
2. If a pin one identification mark is used in addition to a tab, the limits of dimension k do not apply.
3. This dimension allows for off-center lid, meniscus, and glass overrun.
4. Dimensions b1 and c1 apply to lead base metal only. Dimension M applies to lead plating and finish thickness. The maximum limits of lead dimensions b and c or M shall be measured at the centroid of the finished lead surfaces, when solder dip or tin plate lead finish is applied.
5. N is the maximum number of terminal positions.
6. Measure dimension S1 at all four corners.
7. For bottom-brazed lead packages, no organic or polymeric materials shall be molded to the bottom of the package to cover the leads.
8. Dimension Q shall be measured at the point of exit (beyond the meniscus) of the lead from the body. Dimension Q minimum shall be reduced by 0.0015 inch (0.038mm) maximum when solder dip lead finish is applied.
9. Dimensioning and tolerancing per ANSI Y14.5M - 1982.
10. Controlling dimension: INCH.