

## Miniature Pushbuttons

## KB Series

### Square • Bushing Mount

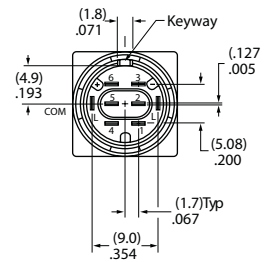
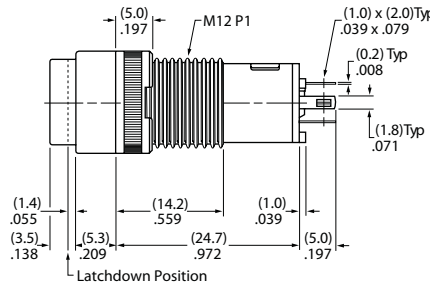
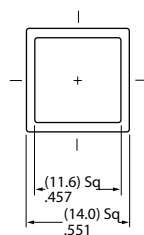

**KB15SKW01-05-GG** Single & Double Pole

Single pole models do not have terminals 4, 5, & 6.

### Round • Bushing Mount

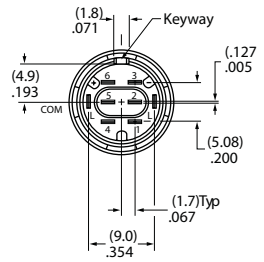
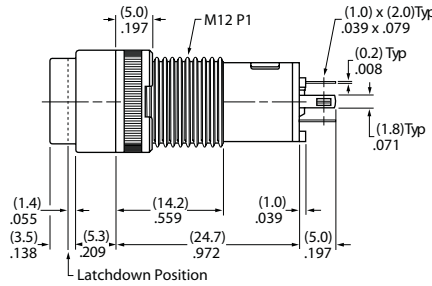
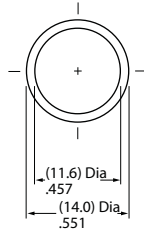

**KB25CKW01-05-GG** Single & Double Pole

Single pole models do not have terminals 4, 5, & 6.

### Rectangular • Bushing Mount

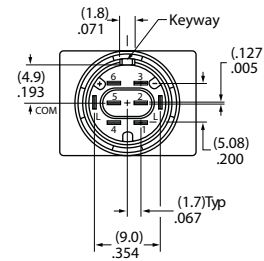
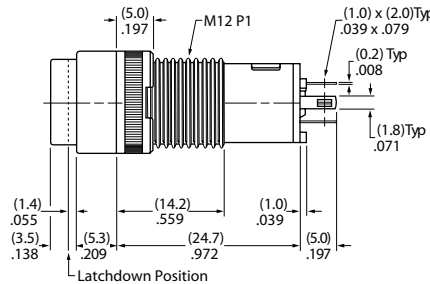
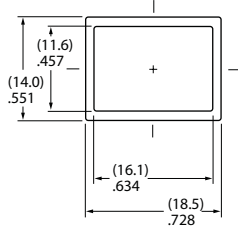

**KB15RKW01-05-GG** Single & Double Pole

Single pole models do not have terminals 4, 5, & 6.

## How to order:

KB       -  -

#### 1 POLES:

- 1 SPDT
- 2 DPDT

#### 2 CIRCUITS:

- 5 ON-ON
- 6 ON-ON (Alternate Action with Latchdown)

#### 3 SHAPES:

- Bushing Mounting
- S Square
- C Round
- R Rectangular

#### Snap-in Mounting

- K Square
- M Round
- N Rectangular

#### 4 HOUSING:

- K Black only

#### 5 CONTACTS & TERMINALS:

- W01** Silver Contacts and Solder Lug Terminals  
1A @ 125/250V AC
- G01** Gold Contacts and Solder Lug Terminals  
0.4VA @ 28V AC/DC

#### 6 BARRIER TYPE:

- Blank No Barrier
- B With Barrier

#### 7 LAMPS:

- Type1: Incandescent Lamp used with Solid Cap
- 05 5-volt
- 12 12-volt
- Type2: Incandescent or Neon used w / Insert Cap
- 01 110-volt Neon
- 05 5-volt Incandescent
- 12 12-volt Incandescent

#### Type 3: Bright LED used with LED Cap

	No Resistor	5-volt	12-volt	24-volt
Red	5C	5C05	5C12	5C24
Amber	5D	5D05	5D12	5D24
Green	5F	5F05	5F12	5F24

#### Type 4: Super Bright LED used with LED Cap

- 6B White
- 6F Green
- 6G Blue

#### 8 CAPS TYPES & COLORS:

Solid Cap: Lens/Filter Colors (for type 1 lamp)

- BB White/White
- CB Red/White
- CC Red/Red
- EB Yellow/White
- FB Green/White
- FF Green/Green
- GB Blue/White
- GG Blue/Blue

Insert Cap: Lens/Filter Colors (for type 2 lamp)

- JB Clear/White
- JC Clear/Red
- JE Clear/Yellow
- \*JF Clear/Green
- \*JG Clear/Blue

\* JF & JG not suitable with neon.

LED Cap: Lens/Diffuser Colors (for type 3 lamp)

- JB Clear/White
- JC Clear/Red
- JD Clear/Amber
- JF Clear/Green
- AB Square Spot Illuminated  
Black Cap/White Window

LED Cap: Lens/Diffuser Colors (for type 4 lamp)

- JB Clear/White

### TYPICAL SWITCH DIMENSIONS

Square • Snap-in Mount

Single & Double Pole

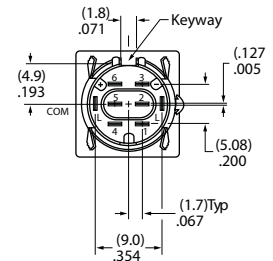
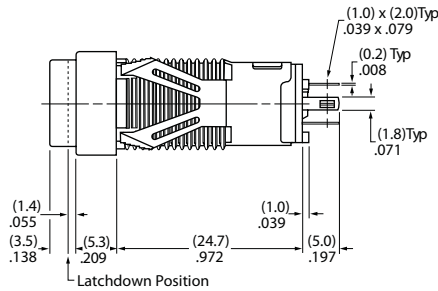
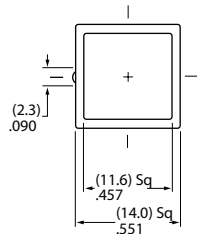

KB16KKW01-05-CB

Single pole models do not have terminals 4, 5, & 6.

Round • Snap-in Mount

Single & Double Pole

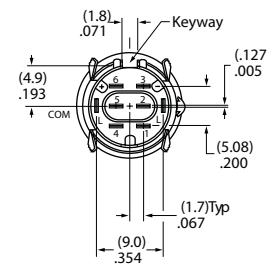
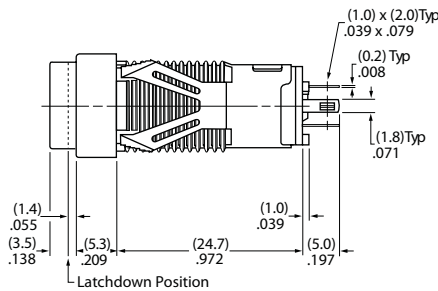
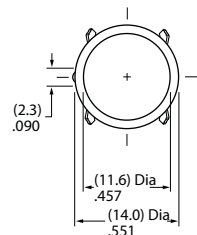

KB26MKW01-05-CB

Single pole models do not have terminals 4, 5, & 6.

Rectangular • Snap-in Mount

Single & Double Pole

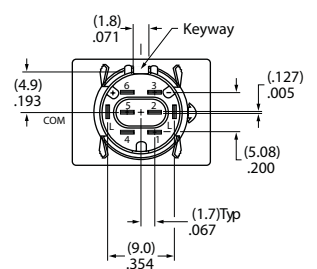
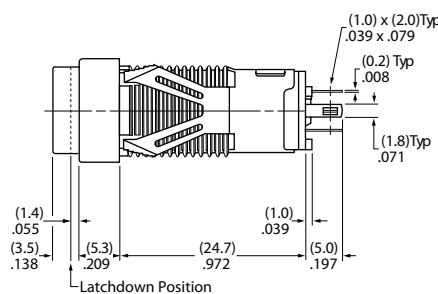
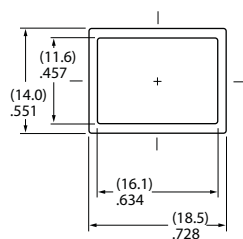

KB16NKW01-05-CB

Single pole models do not have terminals 4, 5, & 6.

### TYPICAL SWITCH DIMENSIONS

Square • Barrier • Bushing Mount

Single & Double Pole

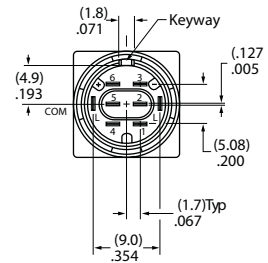
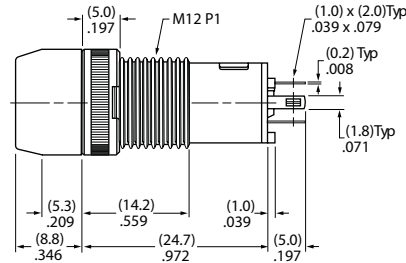
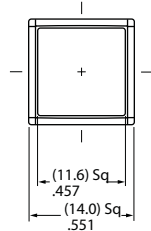

KB15SKW01B-6G-JB

Single pole models do not have terminals 4, 5, & 6.

Square • Barrier • Snap-in Mount

Single & Double Pole

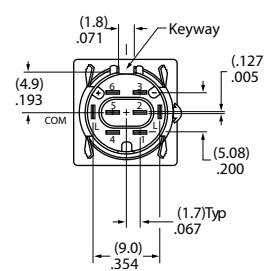
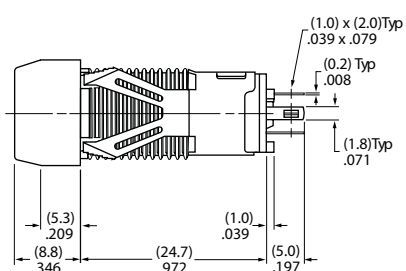
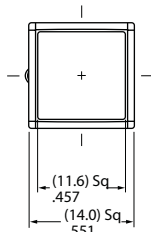

KB15KKW01B-5C-JC

Single pole models do not have terminals 4, 5, & 6.

Rectangular • Barrier • Bushing Mount

Single & Double Pole

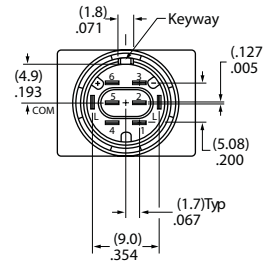
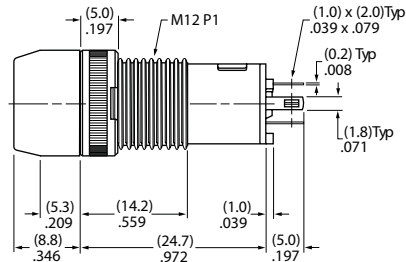
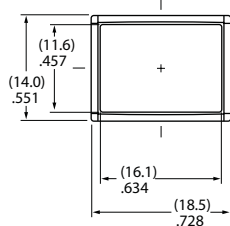

KB15RKW01B-5F-JF

Single pole models do not have terminals 4, 5, & 6.

Rectangular • Barrier • Snap-in Mount

Single & Double Pole

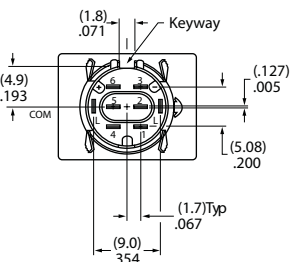
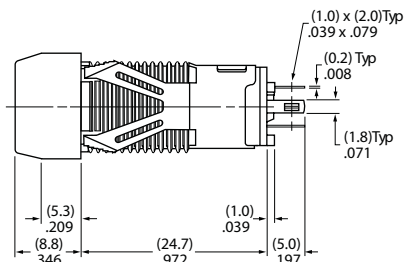
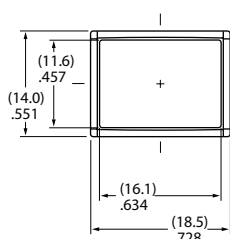

KB15NKKW01B-5D-JD

Single pole models do not have terminals 4, 5, & 6.

Illuminated Switches

## General Specifications

### Electrical Capacity (Resistive Load)

Power Level (silver):	1A @ 125/250V AC or 1A @ 30V DC
Logic Level (gold):	0.4VA maximum @ 28V AC/DC maximum (Applicable Range 0.1mA ~ 0.1A @ 20mV ~ 28V) Note: Find additional explanation of operating range in Supplement section.

### Other Ratings

Contact Resistance:	50 milliohms maximum
Insulation Resistance:	1,000 megohms minimum @ 500V DC
Dielectric Strength:	For Silver: 1,000V AC minimum between contacts for 1 minute minimum & 1,500V AC minimum between contacts & case for 1 minute minimum For Gold: 750V AC minimum between contacts for 1 minute minimum & 1,500V AC minimum between contacts & case for 1 minute minimum
Mechanical Life:	100,000 operations minimum
Electrical Life:	50,000 operations minimum for silver; 100,000 operations minimum for gold
Nominal Operating Force:	Single pole 0.98 ~ 2.45N for maintained & 0.98 ~ 1.96N for momentary; Double pole 1.47 ~ 3.43N for maintained & 1.47 ~ 2.94N for momentary
Contact Timing:	Nonshorting (break-before-make)
Travel:	Pretravel .087" (2.2mm); Overtravel .031" (0.8mm); Total Travel .118" (3.0mm)

### Materials & Finishes

Housing:	Polyamide (UL94V-0)
Movable Contactor:	Silver for power circuit; copper with gold plating for logic level circuit
Stationary Contacts:	Silver for power circuit; copper with gold plating for logic level circuit
Housing Base:	Polyamide (UL94V-0)
Terminal Base:	Polyester
Common Terminals:	Phosphor bronze with silver flash plating for power circuit; Phosphor bronze with gold flash plating for logic level circuit
End Terminals:	Brass with silver flash plating for power circuit; Brass with gold flash plating for logic level circuit
Lamp Terminals:	Phosphor bronze with nickel flash plating

### Environmental Data

Operating Temp Range:	-25°C through +50°C (-13°F through +122°F)
Humidity:	90 ~ 95% humidity for 96 hours @ 40°C (104°F)
Vibration:	10 ~ 55Hz with peak-to-peak amplitude of 1.5mm traversing the frequency range & returning in 1 minute; 3 right angled directions for 2 hours
Shock:	50G (490m/s <sup>2</sup> ) acceleration (tested in 6 right angled directions, with 3 shocks in each direction)

### Installation

Mounting Torque:	0.78Nm (6.9 lb · in) maximum
Cap Installation Force:	4.51N (1.0 lbf) maximum downward force on cap
Soldering Time & Temperature:	Manual Soldering: See Profile A in Supplement section

### Standards & Certifications



Flammability Standards:	UL94V-0 housing & housing base
UL & C-UL Recognized:	Single & double pole models recognized at 1A @ 125/250V AC, 1A @ 30V DC, & 0.4A @ 28V DC; UL File No. WOYR2.E44145: add "/U" to end of part number to order UL mark on switch. UL File No. WOYR8.E44145: add "/C-UL" to end of part number to order C-UL mark on switch.
CSA Certified:	Single & double pole models recognized at 1A @ 125/250V AC, 1A @ 30V DC, & 0.4VA @ 28V maximum; CSA File No. 023535-0-000; add "/C" to end of part number to order CSA mark on switch.

### POLE & CIRCUIT

Pole	Model	Plunger Position ( ) = Momentary		Connected Terminals		Throw & Switch/Lamp Schematics
		Normal	Down	Normal	Down	
SP	KB15 *KB16	ON ON	(ON) ON	2-3	2-1	Notes: Switch is marked with "+" and "-". Lamp circuit is isolated and requires external power source. SPDT
DP	KB25 *KB26	ON ON	(ON) ON	1-3 4-6	2-1 5-4	DPDT

\* When in latchdown position for the alternate circuit, cap position is .055" (1.4mm) above the built-in bezel.

### CUTAWAY



### MOUNTING TYPES & SHAPES

#### Bushing Mounting

**S** .551" (14.0mm)  
Square

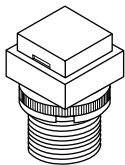

No barrier

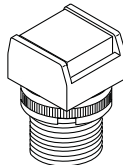

With barrier

**C** .551" (14.0mm)  
Round

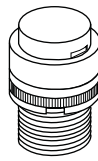

**R** .551" x .728" (14.0mm x 18.5mm)  
Rectangular

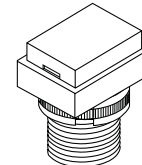

No barrier

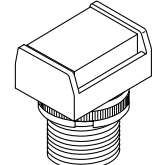

With barrier

Bezel or barrier is an integral part of the switch body. One mounting nut AT057 supplied with each switch.

#### Snap-in Mounting

**K** .551" (14.0mm)  
Square

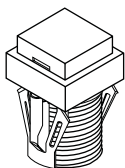

No barrier

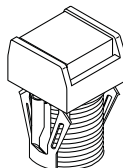

With barrier

**M** .551" (14.0mm)  
Round

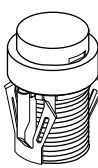

**N** .551" x .728" (14.0mm x 18.5mm)  
Rectangular

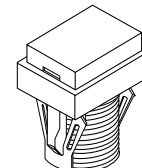

No barrier

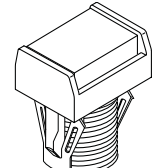

With barrier

Bezel or barrier is an integral part of the switch body.

#### Panel Cutouts

##### Bushing Mounting

Without Keyway

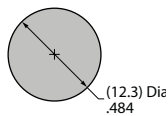

Panel Thickness:  
.020" ~ .315"  
(0.5 ~ 8.0mm)

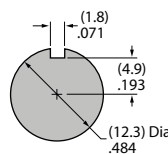

With Keyway

##### Snap-in Mounting

Panel Thickness:  
.039" ~ .138"  
(1.0 ~ 3.5mm)

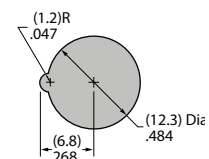

Panel thicknesses, when using optional accessories, are shown with the accessories at the end of this KB section.

### CONTACT MATERIALS, RATINGS & TERMINALS



Silver Contacts

Power Level  
1A @ 125V AC & 250V AC



Solder Lug

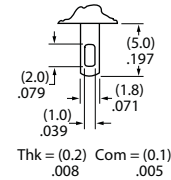

Gold Contacts

Logic Level  
0.4VA maximum @ 28V AC/DC

Complete explanation of operating range in Supplement section.

A partitioned plastic guard is supplied with each switch to provide insulation between terminals.  
Installation steps:

1. Identify wire-to-terminal connections.
2. Thread wires through the guard.
3. Solder the connections.
4. Push the guard fully onto the switch body.

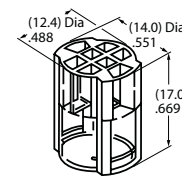

### LAMP COLORS & SPECIFICATINS

The electrical specifications shown are determined at a basic temperature of 25°C  
LED circuit is isolated and requires external power source. Polarity marks are on the bottom of the switch.  
If the source voltage exceeds the rated voltage, a ballast resistor is required.  
The resistor value can be calculated by using the formula in the Supplement section.  
Ambient Temperature Range for lamps below: -25°C ~ +50°C.

#### Incandescent & Neon Lamps

AT611 Incandescent	AT615 Neon		05	12	01	Recommended Resistors for Neon: 33K ohms for 110V AC; 100K ohms for 220V AC	
		Voltage	5V AC	12V AC	110V AC		
		Current	115mA	60mA	1.5mA		
		Endurance	7,000 average		10,000		

#### Bright LED with Resistor

AT634	Color Codes			Resistor Codes		
	Red	Amber	Green	05	12	24
LEDs are colored in OFF state.	5C	5D	5F			

AT634  
5-volt  
2-element  
with 1 Resistor

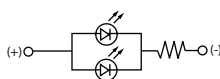

AT634  
12-volt  
4-element  
with 2 Resistors

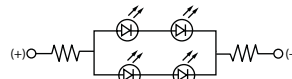

AT634  
24-volt  
4-element  
with 2 Resistors

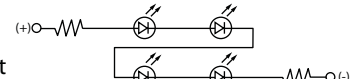

### LAMP COLORS & SPECIFICATIONS

#### Bright LED without Resistor

AT635  LEDs are colored in OFF state.   T-1 1/2 Bi-pin				No Code No Resistor				
	Color Codes	5C	5D	5F	Red	Amber	Green	
	Forward Peak Current				$I_{FM}$	30mA	30mA	30mA
	Continuous Forward Current				$I_F$	20mA	20mA	20mA
	Forward Voltage				$V_F$	1.9V	2.0V	2.1V
	Reverse Peak Voltage				$V_{RM}$	5V	5V	5V
	Current Reduction Rate Above 25°C				$\Delta I_F$	0.42mA/°C		
Ambient Temperature Range					-25° ~ +50°C			

#### Super Bright Single Element LED

AT625G Blue  AT631B White  AT632F Green   T-1 Bi-pin				6B	6F	6G		
	Color	White	Green	Blue				
	Forward Peak Current				$I_{FM}$	30mA	30mA	30mA
	Continuous Forward Current				$I_F$	20mA	20mA	20mA
	Forward Voltage				$V_F$	3.6V	3.5V	3.6V
	Reverse Peak Voltage				$V_{RM}$	5V	5V	5V
	Current Reduction Rate Above 25°C				$\Delta I_F$	0.50mA/°C	0.50mA/°C	0.50mA/°C
Ambient Temperature Range					-25° ~ +50°C			

### CAP TYPES & COLOR COMBINATIONS

Color Codes:      A Black      B White      C Red      E Yellow      F Green      G Blue      J Clear

#### Solid Cap for Incandescent Lamp

Lens/Filter Colors Available:

- |    |    |
|----|----|
| BB | FB |
| CB | FF |
| CC | GB |
| EB | GG |

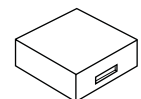
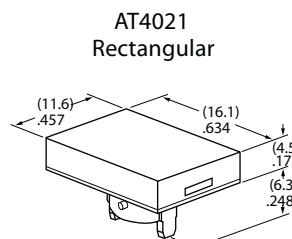
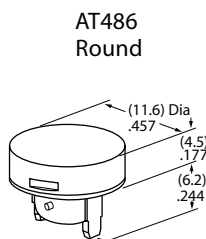
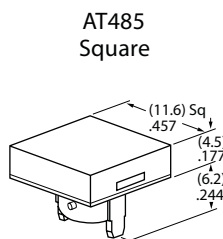

Translucent Colored Lens

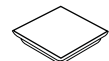

Translucent Colored Filter



Lamp AT611

Material: Polycarbonate      Finish: Glossy

#### Insert Cap for Incandescent or Neon Lamp

Lens/Filter Colors Available:

- |    |    |
|----|----|
| JB | JF |
| JC | JG |
| JE |    |

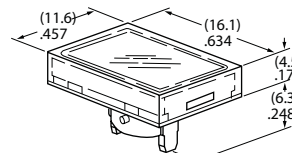
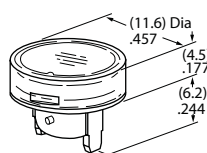
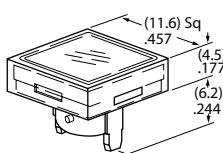

Transparent Clear Lens



Translucent Colored Filter



Lamp AT611      Lamp AT615

JF and JG not suitable with neon lamp.

Material: Polycarbonate      Finish: Glossy

### OPTIONAL ACCESSORIES

Color Codes:    A Black    B White    C Red    D Amber    E Yellow    F Green    G Blue    J Clear

#### Spot Illuminated Cap for Bright LED without Resistor or with Resistor

Cap/Window Colors Available:

**AB** Opaque Black Cap with Translucent White Window for Spot Illumination

AT4051 Square

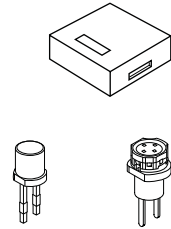
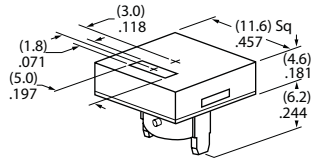

Bright LED AT635    Bright LED AT634

Material: Polycarbonate    Finish: Matte

#### Cap for Bright LED without Resistor or LED with Resistor

Lens/Diffuser Colors Available: (AT4133, 4132, 4134 white diffusers; AT4158, 4160, 4159 colored diffusers)

**JB**

AT4133

AT4132

AT4134

Square

Round

Rectangular

Transparent Clear Lens

**JC**

AT4158

AT4160

AT4159

**JD**

**JF**

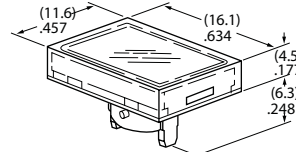
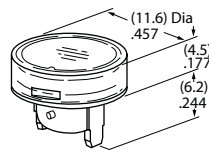
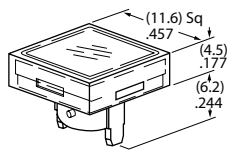

Translucent Diffuser



Bright LED AT635    Bright LED AT634

Material: Polycarbonate    Finish: Glossy

#### Cap for Super Bright LED

Lens/Diffuser Colors Available:

**JB**

AT4133 Square

AT4132 Round

AT4134 Rectangular

Translucent Clear Lens

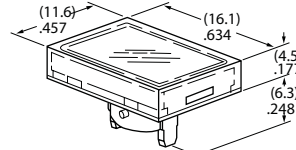
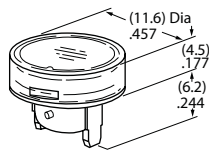
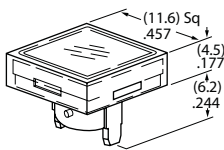

Translucent White Diffuser



Super Bright LEDs AT625 AT631 AT632

Material: Polycarbonate    Finish: Glossy



### OPTIONAL ACCESSORIES

#### PCB Adaptors

**AT701**  
Single Pole  
Straight PC  
Terminals



**AT702**  
Double Pole  
Straight PC  
Terminals



**AT077**  
Single Pole  
Right Angle  
PC Terminals

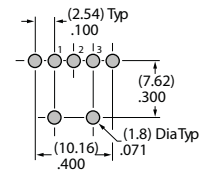
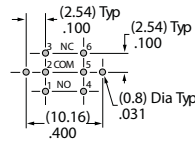
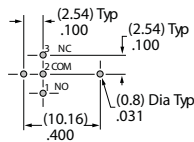
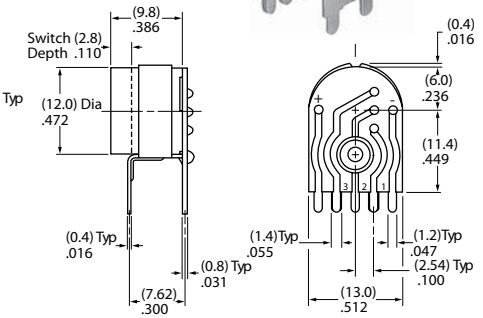
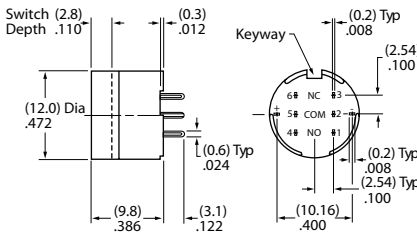
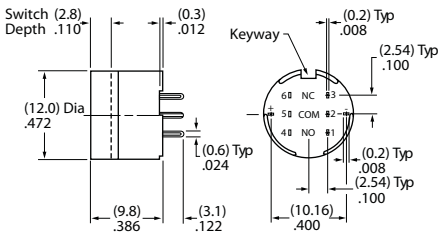

Material: Glass fiber reinforced polyamide Note: Order adaptors separately

#### Dust Covers

Panel Thickness Range: .020 ~ .268" (0.5 ~ 6.8mm) for Bushing Mounting; .020 ~ .079" (0.5 ~ 2.0mm) for Snap-in Mounting  
Dust Covers reduce the depth of switch behind panel by .047" (1.2mm).

**AT495**  
For Square & Round  
(not for Barrier type)

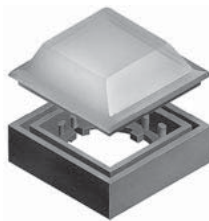

**AT4025**  
For Rectangular  
(not for Barrier type)

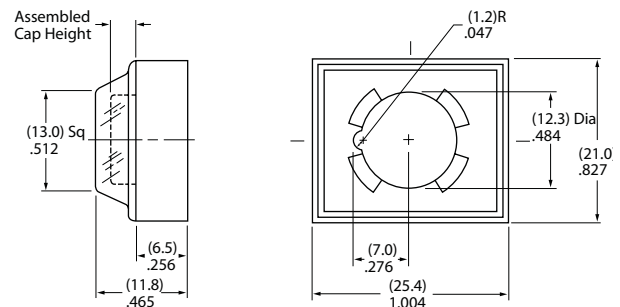
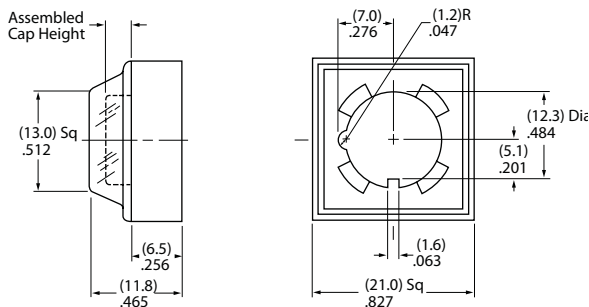
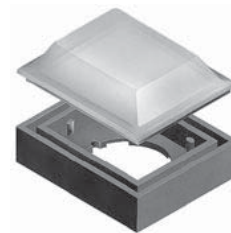

Material: Lid: PVC PVC loses pliability below 0°C (32°F).

Base: Polyamide

### OPTIONAL ACCESSORIES

**AT494**  
For Square & Round  
(not for Barrier type)

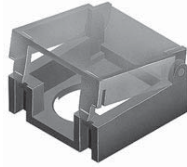

**Protective Guards**

**AT4024**  
For Rectangular  
(not for Barrier type)



Panel Thickness  
Range:

.020" ~ .268"  
(0.5 ~ 6.8mm)  
for Bushing Mounting

.020" ~ .091"  
(0.5 ~ 2.3mm)  
for Snap-in Mounting

Protective Guards reduce  
the depth of switch  
behind panel by  
.047" (1.2mm).

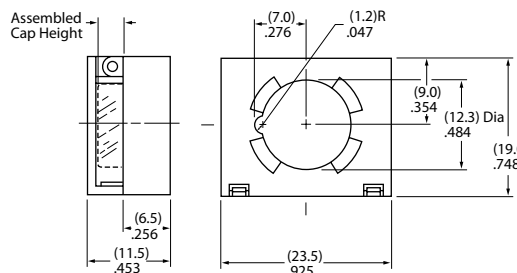
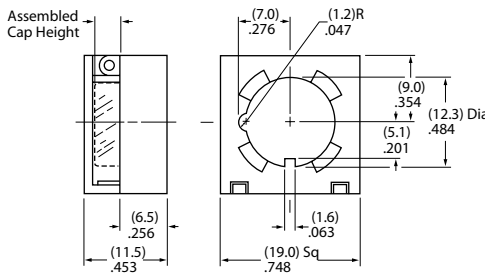

Material: Cover: Polycarbonate

Base: Polyamide

### ASSEMBLY INSTRUCTIONS

#### Cap Removal & Installation

For alternate action models cap must be in UP position for cap removal. Indentations on opposite sides of the cap provide an easy way to lift the cap out of the holder, using either the finger nails, or cap extractor AT109.

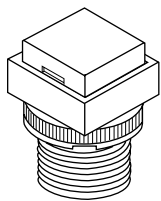

#### LED Polarity & Orientation in Lamp Socket

Super Bright LEDs AT625, AT631, & AT632 are electrostatic sensitive.



LED  
AT635



LED  
AT634



LEDs  
AT625  
AT631  
AT632

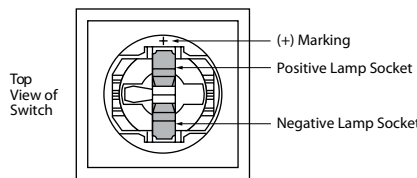
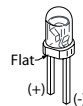

#### Cap Replacement

Note that the cap has a pair of round tabs and a pair of long tabs which should be used for correctly replacing the cap in its holder. Using the long tabs as guides, slide the cap with the long tabs moving into the slots on opposite sides of the cap holder. Then, the round tabs will snap into notches on the other two sides of the holder.

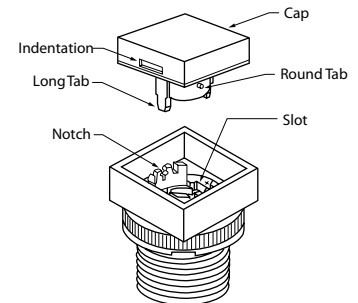

**AT108 Socket Wrench**  
for Bushing Mounting

Overtightening the  
mounting nut  
may damage the  
switch housing.



**AT109 Cap Extractor**



**AT111 Lamping Tool**

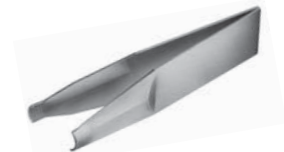

### LEGENDS

General information and basic specifications are presented here for customers who want to do their own legends.

#### Suggested Printable Area for KB Lens

Recommended Methods: Laser Etch on clear lens, Screen Print, or Pad Print on Lens.  
Epoxy based ink is recommended.

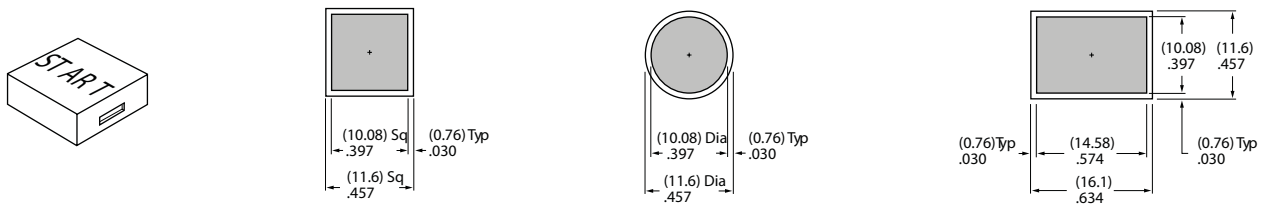

Shaded areas are printable areas.

#### Suggested Printable Area for Film Insert

Recommended Print Method: Screen Print with Epoxy based ink

Film Insert: Clear Polyester, 4 mil max. thickness

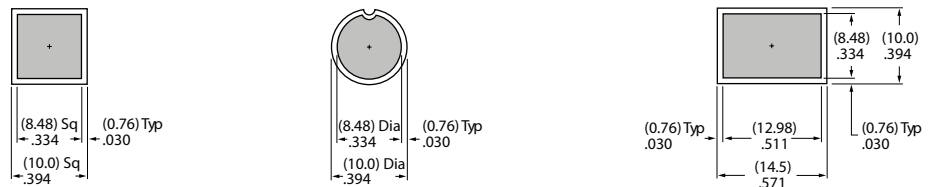
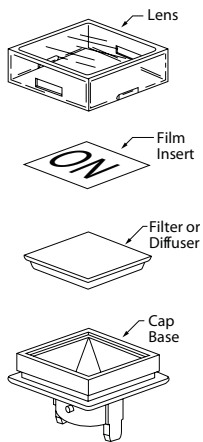

Shaded areas are printable areas.

#### Additional Methods

Additional methods for legends are engraving the lens and laser printing on film inserts.  
Maximum depth for engraving is .012" (0.3mm) on the cap lens.  
Enamel paint is recommended to fill the engraved area.