

APPLICATION NOTE

www.DataSheet4U.com

AN247

PCK2001 (CKBF) reduced EMI techniques

Logic Products Group

1998 May 18

PCK2001 (CKBF) reduced EMI techniques

AN247

INTRODUCTION

This application note describes the background, technique and results of EMI measurements on the PCK2001 (CKBF), showing reduced EMI emissions over standard design techniques. Through the use of circuit design, the high frequency EMI emissions from the CKBF were reduced from a standard design approach. These reduced emissions should help a board/systems manufacturer pass FCC and CISPR EMI requirements.

BACKGROUND OF EMI, FCC AND CISPR STANDARDS

EMI, Electro-Magnetic Interference, is any unwanted electromagnetic signal which may degrade the performance of an electronic device. It is generally thought of as one device creating electromagnetic radiation that interferes with the operation or performance of another device. PCs and PC motherboard designs have to meet standards set by regulatory agencies. Two standards are, FCC (Federal Communications Commission) regulations part 15B, and International Electrotechnical Commission's International Special Committee on Radio Interference (CISPR) 22B. These regulations specify limits:

FCC Part 15B

Frequency (MHz)	Radiation (dB μ V/M)
30–88	40.0
88–216	43.5
216–960	46.0
Above 960	54.0

* Quasi-peak measured at 3 meters.

CISPR 22B Limits

Frequency (MHz)	Radiation (dB μ V/M)
30–230	30.0
230–1000	37.0

* Quasi-peak measured at 10 meters.

Most PC manufactures are required to meet these EMI testing requirements for system level design. Because of the regularity/repetition of the clock signals, the clock synthesis (CK100) and clock buffer (CKBF) in the 440BX (CK97 specification from Intel) designs create a significant amount of noise and EMI. The CK97 specification from Intel does not require spread spectrum techniques on the CK100 synthesis part or other reduced EMI techniques, but only specified spread spectrum as an option. There is also no reference to reduced EMI requirements on the CKBF. Early board builds and subsequent qualifications showed a serious problem with EMI, with a strong correlation to the CK100 and CKBF parts from all vendors. Spread spectrum on the CK100 helped, but Intel asked that the vendors of the clock parts develop a system clock generator (CK100) and distribution (CKBF) with 6–10 dB of radiation reduction.

Figure 1 shows a graphical interpretation of the FCC and CISPR requirements for system level EMI performance.

The testing of the EMI performance of a board under FCC regulations is done as either an open box (plastic) or a closed box (metal/shielded) and an Open Air Test Site (OATS). The antenna for the test is placed 3 meters away (FCC) or 10 meters away (CISPR) in front of the system with peripherals attached, such as keyboard, mouse, and headphones.

Even though the test is a system level test, the main contributors to EMI are, of course, the microprocessor and the clock and data distribution circuit. This application note will focus on the EMI results of the Philips PCK2001 or CKBF. Methods to reduce EMI from a board standpoint are outlined well in the Intel application note, AP589, available at the Intel WEB site, www.intel.com.

As a vendor of clock components, Philips Semiconductors worked to provide a CKBF (PCK2001) with a reduction in the amount of EMI radiation by 6 dB at the 600 MHz point (our internal goal was 10 dB). This was accomplished by designing the device to reduce the high frequency harmonics that were being generated during switching.

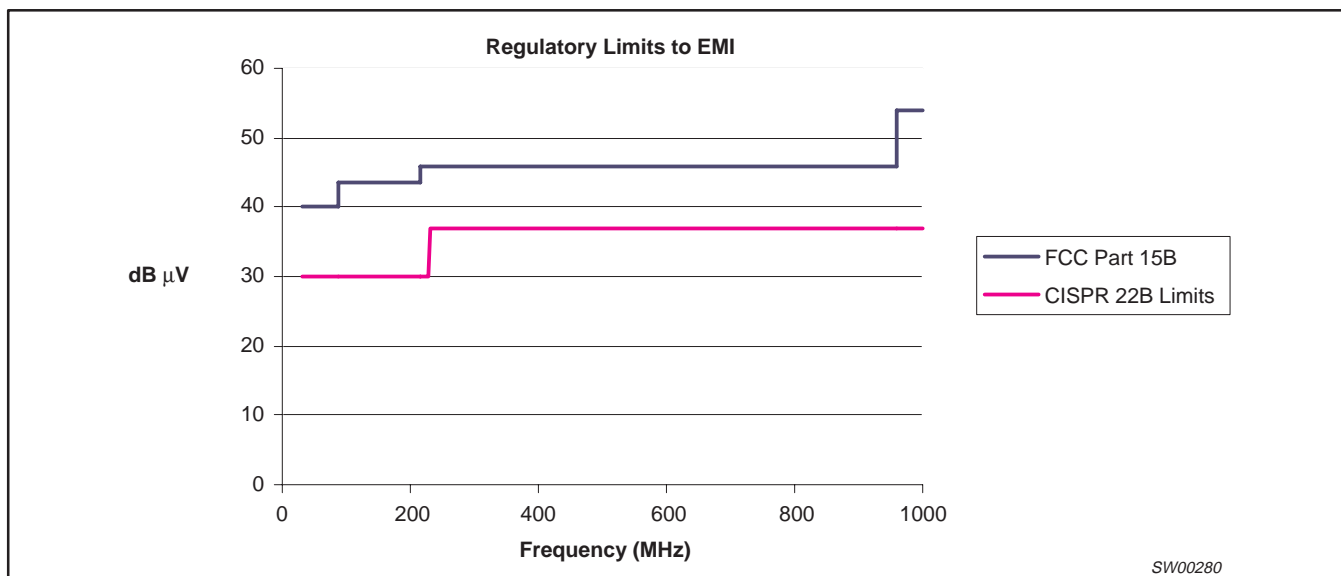

Figure 1. Regulatory Limits

SW00280

PCK2001 (CKBF) reduced EMI techniques

AN247

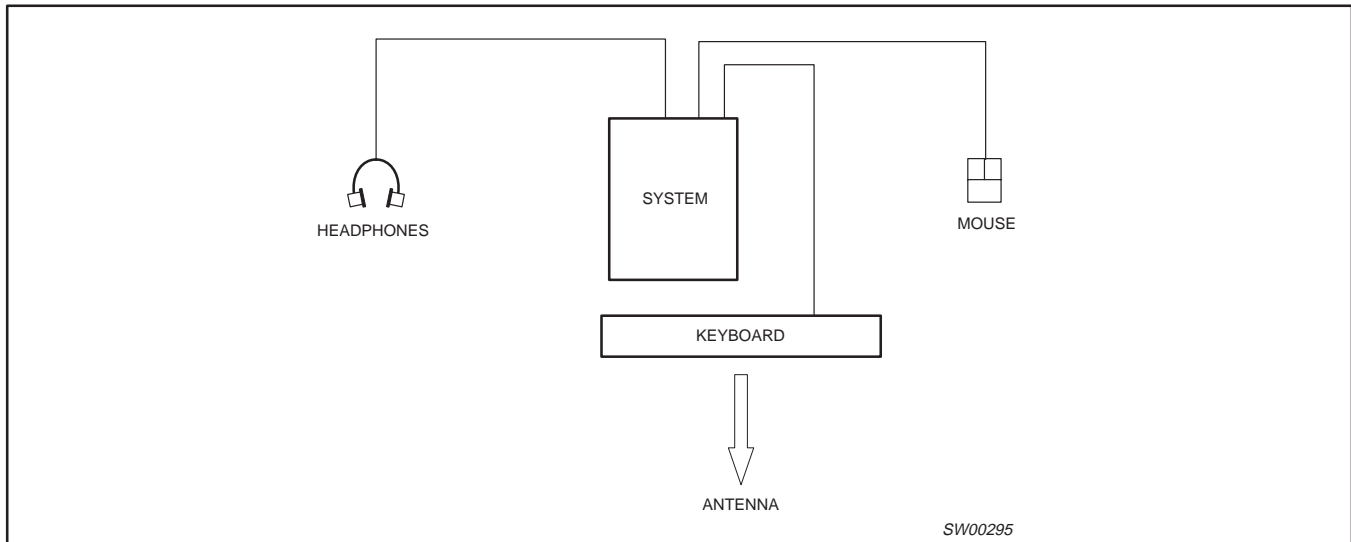

Figure 2. Open Air Test Site

THEORY OF CIRCUIT CHANGES TO REDUCE EMI

There are 4 areas of the circuitry that affect high frequency EMI noise. These are:

1. Output edge-rate and second derivatives (rates of change of edge rates) including internal cells driving the output stage
2. Skewing the output edge placements
3. Feed-through currents
4. Tank circuits (harmonics)
 - Package
 - Supply lines
 - External components

Output Edge-rate and Second Derivatives

The output edge-rate and rates of turn-on and turn-off create the fundamental and harmonic frequencies about the 66 MHz and 100 MHz operating points. Although the output voltage waveform $v(t)$, is not strictly mathematical, it can be approximated by mathematical models to give some idea of the edges and EMI noise produced. The expected general wave shapes are shown below for the output voltage $v(t)$, the ground current $i(t)$ and the ground voltage across the ground lead inductor $Vg(t)$.

Higher frequencies are generated by the rate of change in the output, causing harmonics from the output waveform and the ground noise at higher frequencies.

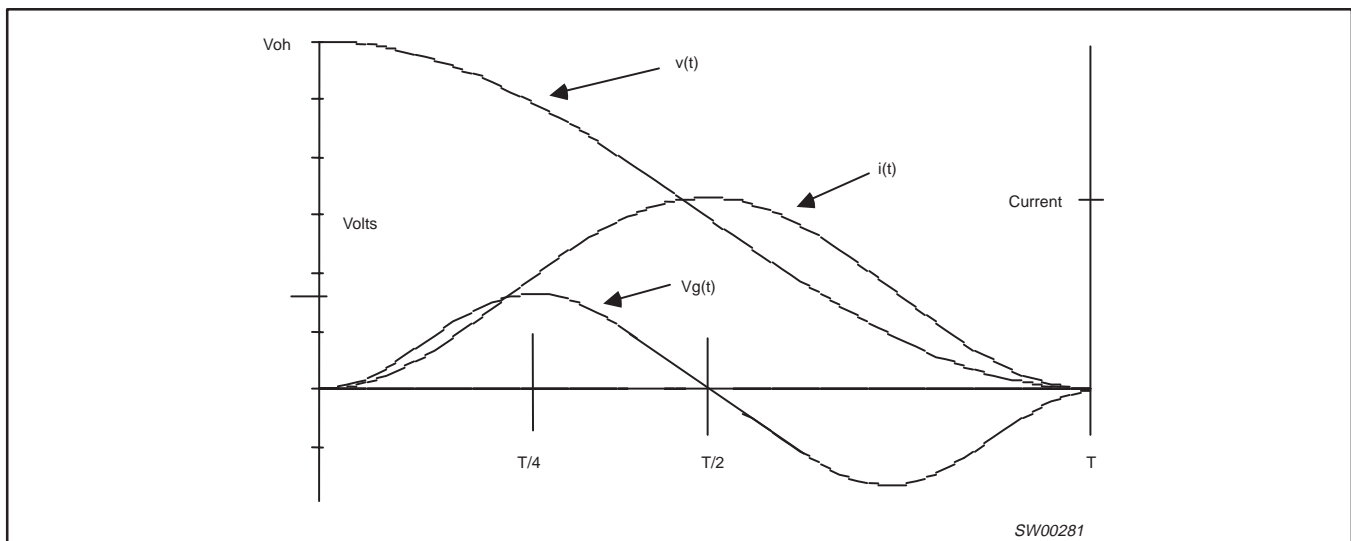

Figure 3. Edge-rate and Ground Bounce

PCK2001 (CKBF) reduced EMI techniques

AN247

Skewing the Output Edge Placements

Skewing the output edge placements spreads the frequency energy slightly off center. Instead of having all the energy hit at exactly 100 MHz, skewing the outputs slightly (but within specification) helps spread the frequencies out similar to a spread spectrum technique.

Instead of having the energy at the same frequency point the energy spike is blurred a little because of the skewed edge placement in time.

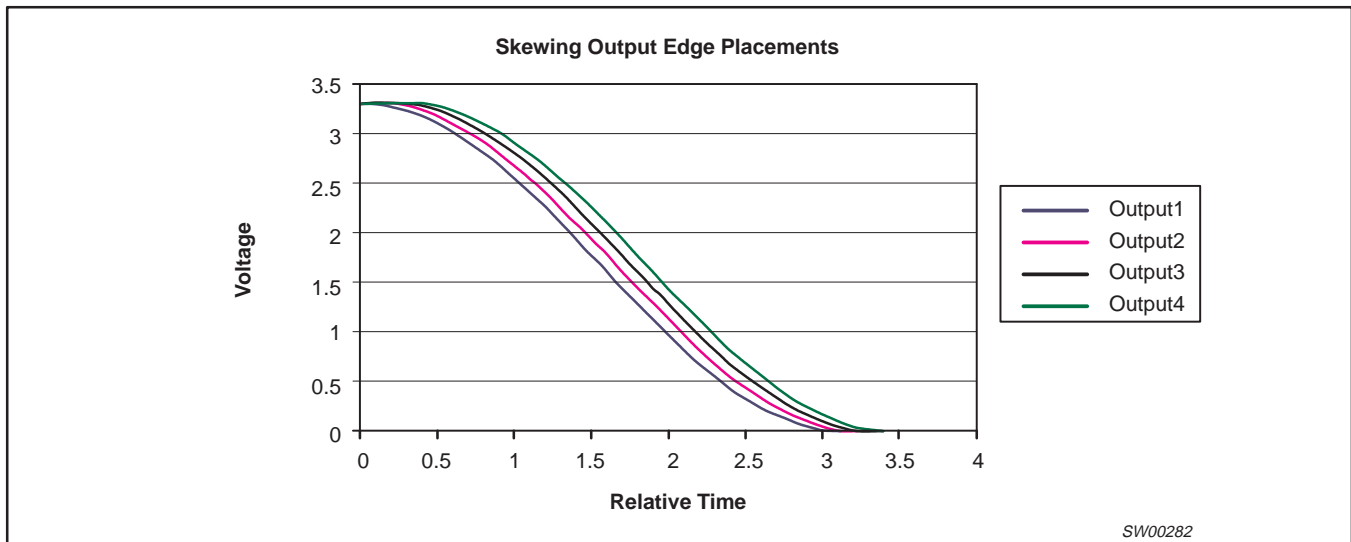

Figure 4. Example of Skewed Output Edge Placements

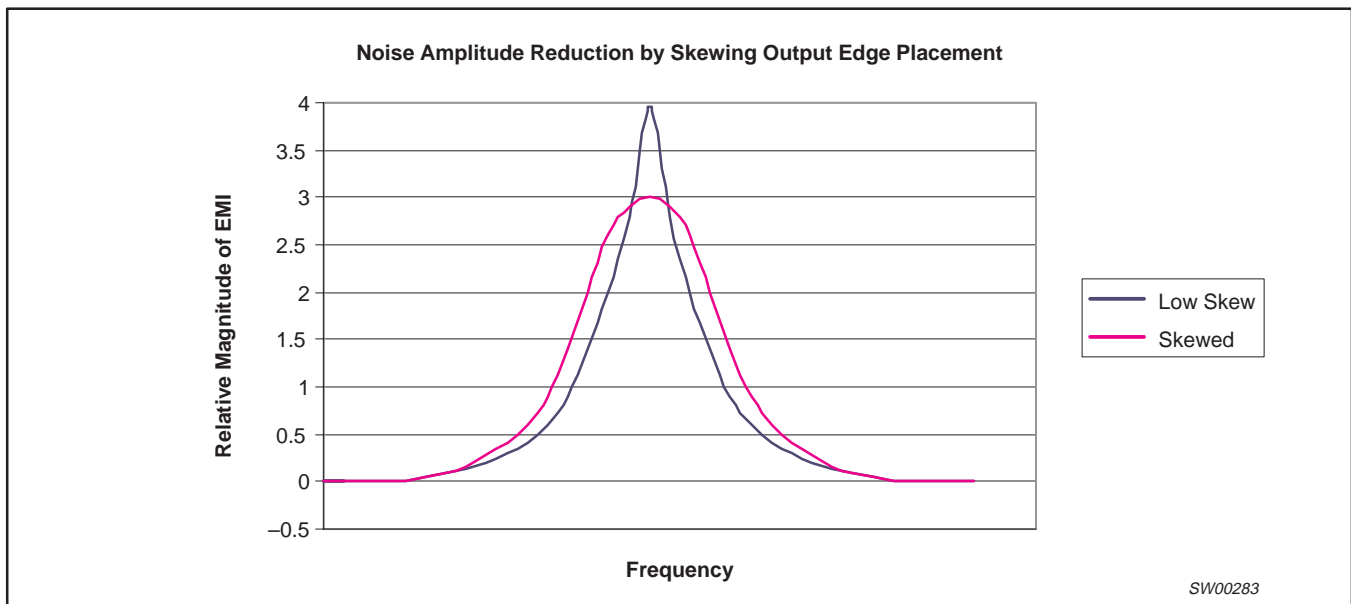

Figure 5. Effect of Skewing the Outputs

PCK2001 (CKBF) reduced EMI techniques

AN247

Feed-through Currents

Feed-through current is the current that flows from V_{DD} to V_{SS} during switching. In a totem pole driver, both upper and lower devices can be on at the same time. The graph below shows the feed-through current of a standard CMOS inverter with respect to time.

These currents flow through the V_{DD} to V_{SS} supply lines causing ground and V_{DD} noise. Equation 1 shows the basic relationship between changing currents through a ground lead with inductance and the voltage generated across the lead.

$$V_g = L * di/dt \tag{Eq. 1}$$

Tank Circuits (harmonics)

Integrated circuit devices are built in packages that have parasitic inductance and capacitance. Although there is damping resistance

in the lines, the parasitic package inductance and load capacitance cause a LC tank circuit with a characteristic resonant frequency and harmonics.

With typical package inductance for output and supply paths and output load capacitance, the resonant frequency is about 100 MHz plus higher harmonics as is calculated from the simple equation,

$$f = \frac{1}{2\pi \sqrt{LC}} \tag{Eq. 2}$$

V_{DD} lines for clock buffers are usually decoupled with larger capacitance and inductance. Added inductance can be used to filter high frequency components of noise thus lowering the EMI.

Figure 7 shows the high to low transition of an output with the damped sinusoidal response typical of a resonant tank circuit.

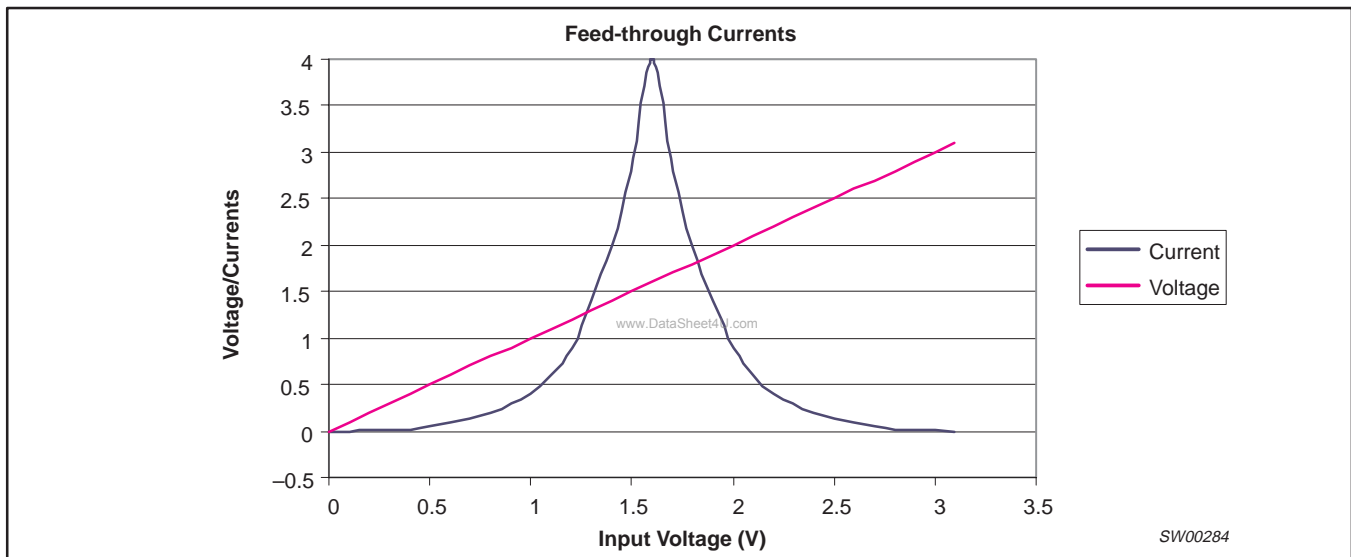

Figure 6. Feed-through Currents

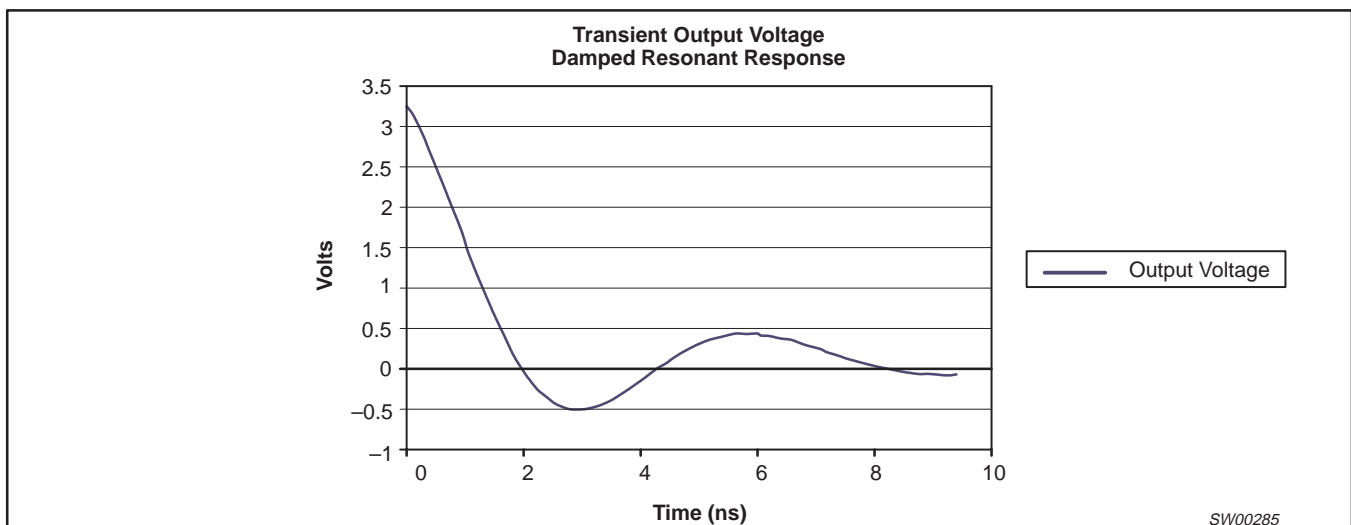

Figure 7. Output Tank Circuit Response

PCK2001 (CKBF) reduced EMI techniques

AN247

IMPLEMENTATION OF CIRCUIT DESIGN TECHNIQUES FOR REDUCED EMI

The design of the Philips PCK2001 (CKBF) circuit incorporated design techniques that would reduce the effects of the four contributors to EMI. These are:

1. minor adjustments to the output edge-rate and wave shaping,
2. skewing the edge placement to the maximum allowable in the specification of 250ps,
3. reduction in any feed-thru currents that might occur,
4. but the most significant change was done in modifying the tank circuits, particularly in the V_{DD} supply lines.

The major design focus was the addition of a large on-chip decoupling capacitance and adding series resistance in the 10 V_{DD} supply lines shown in Figure 8. The addition of the capacitance and resistance has the effect of filtering out the high frequency noise components in the power supply lines.

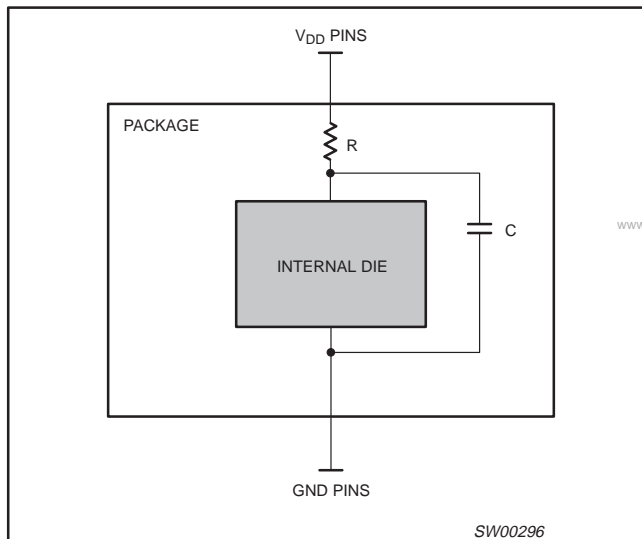

Figure 8. Added On-Chip Decoupling Capacitance and Series Resistance

MEASURED RESULTS BY PHILIPS

The following graphs show the comparison between a prototype PCK2001 (CKBF) and the released Philips PCK2001 EMI reduced part as measured by Philips Semiconductors. Figure 9 is the prototype design with the measured frequency response. Figure 10 is the released design. A bar graph comparing of emissions at frequency is shown in Figure 11.

The most reductions came in the frequency ranges between 300 MHz and 900 MHz. At 600 MHz, the reduction was about 10dB μ V.

Measurements were done using Industrial Standard SAE methods, as defined in an EMC component requirement SAE 1752-2/3 (Automotive Association).

PCK2001 (CKBF) reduced EMI techniques

AN247

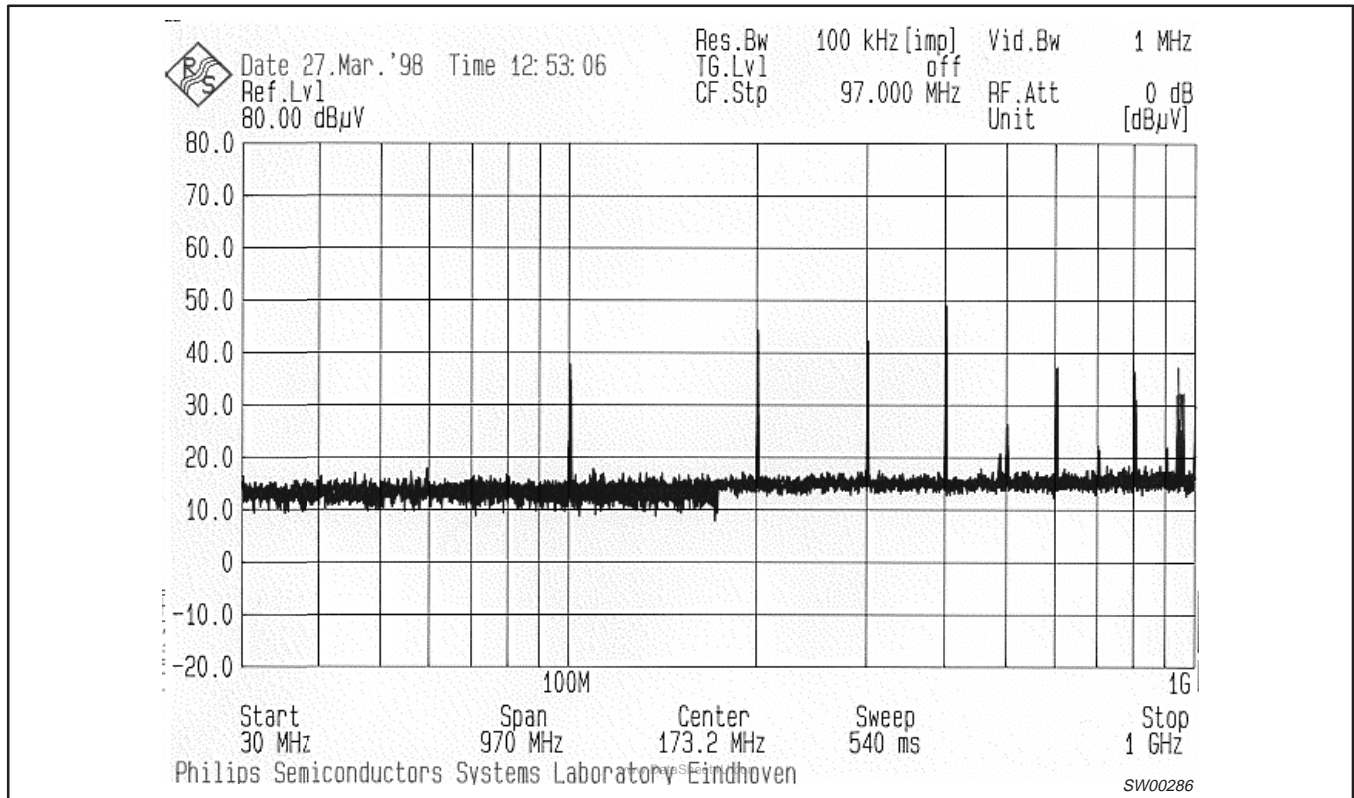

Figure 9. Prototype Circuit EMI with Standard Circuitry

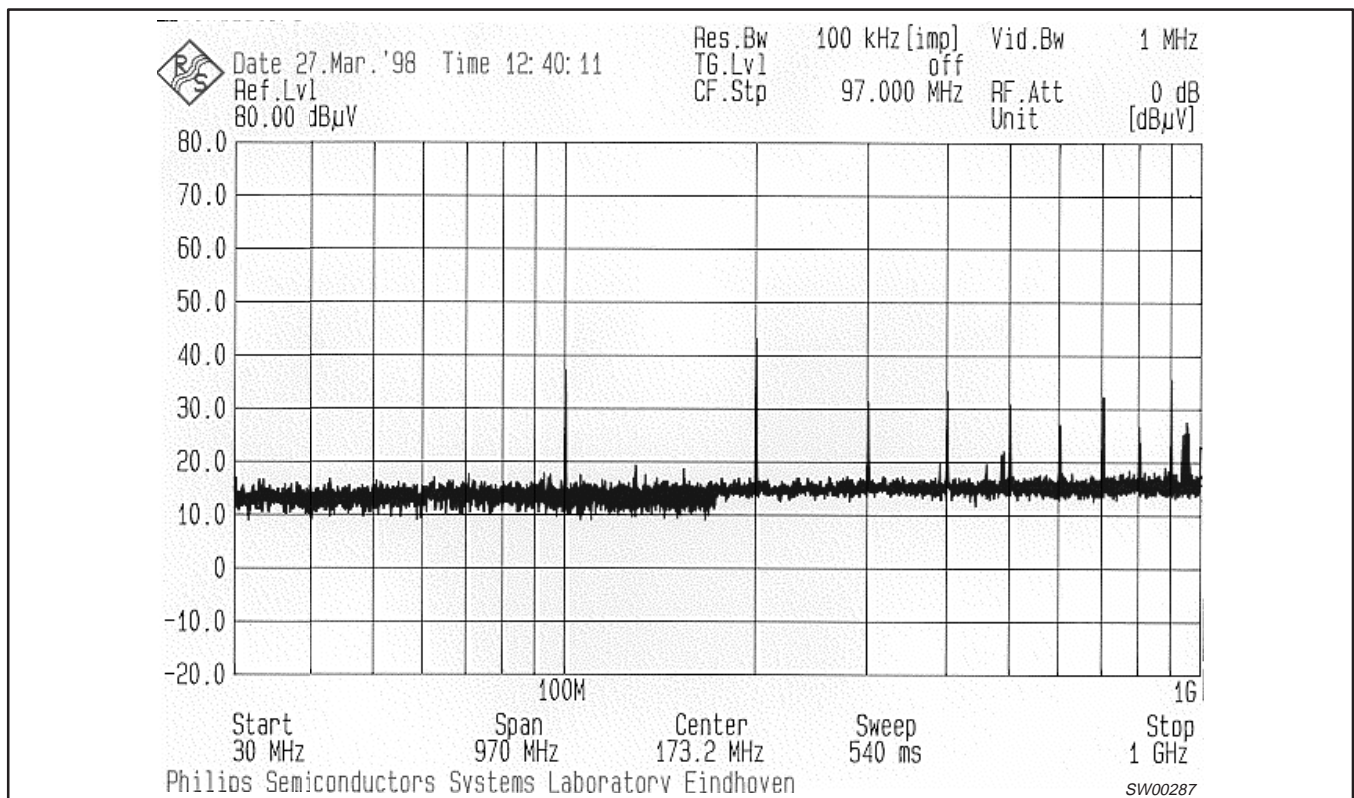

Figure 10. Released PCK2001 (CKBF) with Reduced EMI

PCK2001 (CKBF) reduced EMI techniques

AN247

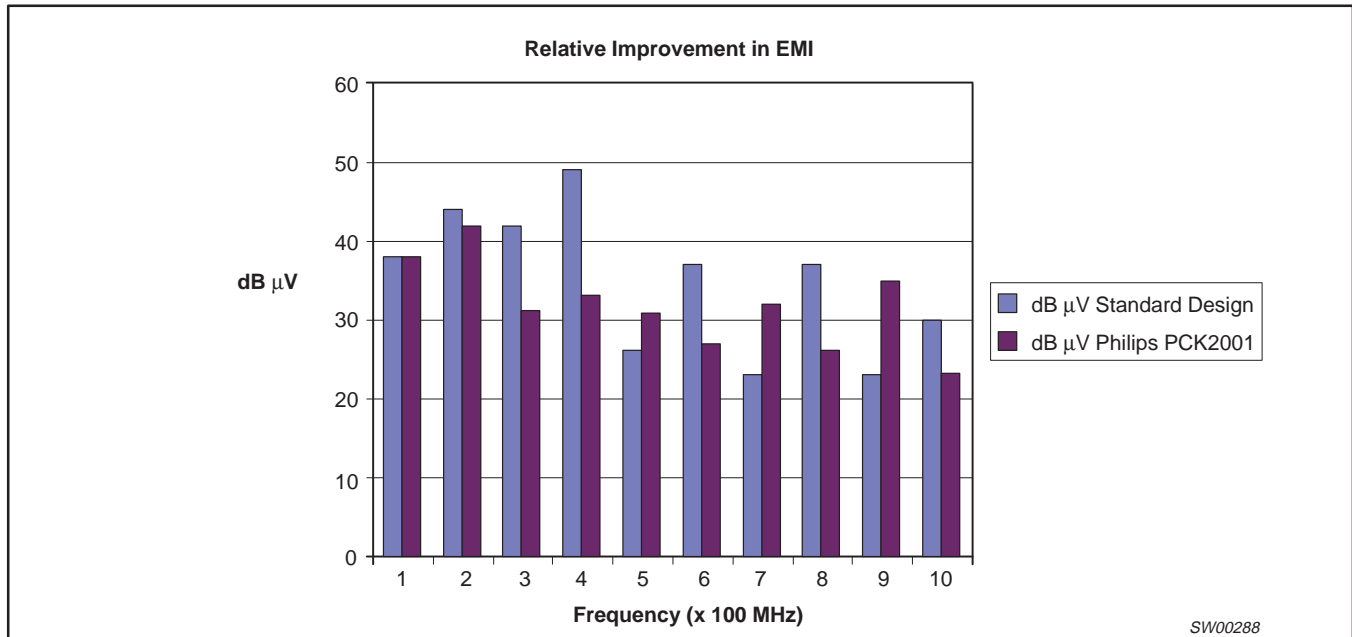

Figure 11. Reduced EMI

SUMMARY AND CONCLUSIONS

EMI emissions from semiconductor devices is a complex field that incorporates both circuit design techniques such as output wave shaping, skewing output edge placements, minimizing feed-through currents and eliminating high frequency tank circuits, and also functional changes to incorporate spread spectrum in clock synthesis parts. The PCK2001 uses techniques to minimize emissions and therefore helps systems designers meet FCC and CISPR regulations.

The measured results show a 6–10 dB μ V reduction in emissions. These were device level measurements to the SAE standard. Since the FCC regulations is a system level requirements and is the sum of all the devices in the system. The contribution to the reduction in EMI emissions from the PCK2001 will only be a part of the measured improvements. Board design and reductions from other components will be important to meet FCC and CISPR regulations.

PCK2001 (CKBF) reduced EMI techniques

AN247

NOTES

www.DataSheet4U.com

PCK2001 (CKBF) reduced EMI techniques

AN247

Definitions

Short-form specification — The data in a short-form specification is extracted from a full data sheet with the same type number and title. For detailed information see the relevant data sheet or data handbook.

Limiting values definition — Limiting values given are in accordance with the Absolute Maximum Rating System (IEC 134). Stress above one or more of the limiting values may cause permanent damage to the device. These are stress ratings only and operation of the device at these or at any other conditions above those given in the Characteristics sections of the specification is not implied. Exposure to limiting values for extended periods may affect device reliability.

Application information — Applications that are described herein for any of these products are for illustrative purposes only. Philips Semiconductors make no representation or warranty that such applications will be suitable for the specified use without further testing or modification.

Disclaimers

Life support — These products are not designed for use in life support appliances, devices or systems where malfunction of these products can reasonably be expected to result in personal injury. Philips Semiconductors customers using or selling these products for use in such applications do so at their own risk and agree to fully indemnify Philips Semiconductors for any damages resulting from such application.

Right to make changes — Philips Semiconductors reserves the right to make changes, without notice, in the products, including circuits, standard cells, and/or software, described or contained herein in order to improve design and/or performance. Philips Semiconductors assumes no responsibility or liability for the use of any of these products, conveys no license or title under any patent, copyright, or mask work right to these products, and makes no representations or warranties that these products are free from patent, copyright, or mask work right infringement, unless otherwise specified.

Philips Semiconductors
811 East Arques Avenue
P.O. Box 3409
Sunnyvale, California 94088-3409
Telephone 800-234-7381

© Copyright Philips Electronics North America Corporation 1998
All rights reserved. Printed in U.S.A.

Date of release: 05-98

Document order number:

9397 750 03939

Let's make things better.