

PLEASE CHECK WWW.MOLEX.COM FOR LATEST PART INFORMATION

Part Number: [0022011104](#)
Status: **Active**
Overview: [spox](#)
Description: 2.50mm (.098") Pitch SPOX™ Wire-to-Wire and Wire-to-Board Receptacle Housing, 10 Circuits

Documents:

3D Model	Product Specification PS-5102-002 (PDF)
Drawing (PDF)	Product Specification PS-5102-004 (PDF)
Product Specification PS-5045-001 (PDF)	RoHS Certificate of Compliance (PDF)
Product Specification PS-5045-002 (PDF)	

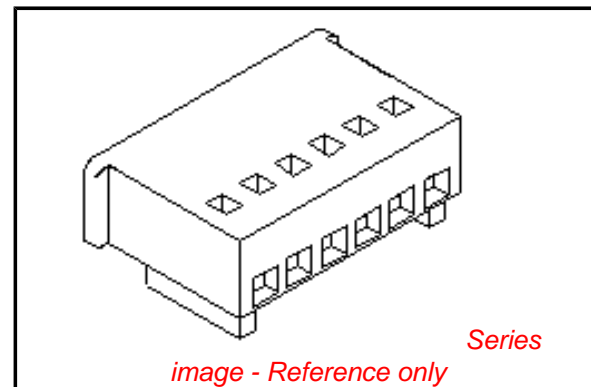

Agency Certification

CSA	LR19980
TUV	R72090224
UL	E29179

General

Product Family	Crimp Housings
Series	5102
Overview	spox
Product Name	SPOX™

Physical

Circuits (maximum)	10
Color - Resin	Natural
Flammability	94V-0
Gender	Female
Glow-Wire Compliant	No
Lock to Mating Part	Yes
Material - Resin	Nylon
Number of Rows	1
Packaging Type	Bag
Panel Mount	No
Pitch - Mating Interface (in)	0.098 In
Pitch - Mating Interface (mm)	2.50 mm
Polarized to Mating Part	Yes
Stackable	No
Temperature Range - Operating	-40°C to +105°C

Material Info

Old Part Number	5102-10
-----------------	---------

Reference - Drawing Numbers

Product Specification	PS-5045-001, PS-5045-002, PS-5102-002, PS-5102-004
Sales Drawing	SD-5102-001

EU RoHS

ELV and RoHS Compliant
REACH SVHC Contains SVHC: No
Halogen-Free Status

China RoHS



Need more information on product environmental compliance?

Email productcompliance@molex.com
 For a multiple part number RoHS Certificate of Compliance, [click here](#)

Please visit the [Contact Us](#) section for any non-product compliance questions.

Search Parts in this Series

[5102Series](#)

Mates With

[5045](#) Vertical Header, [5046](#) Right Angle Header

Use With

[5103](#) Crimp Terminals

10 9 8 7 6 5 4 3 2 1

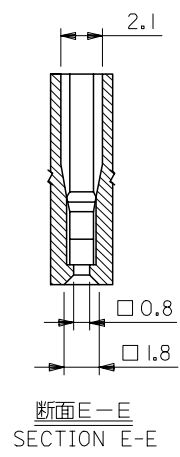
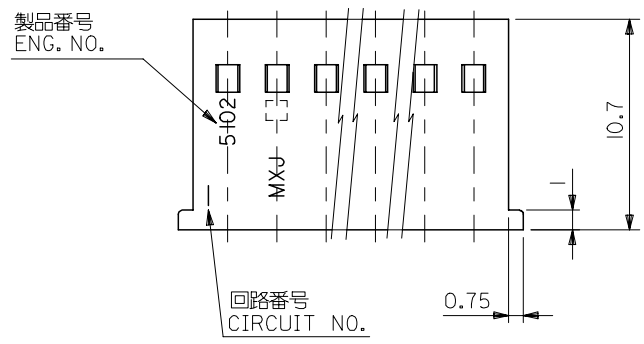
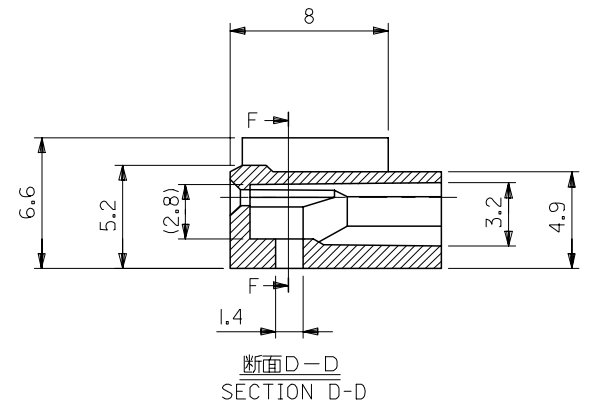
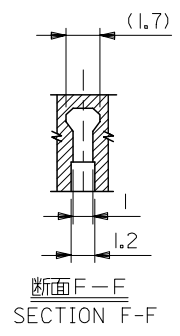
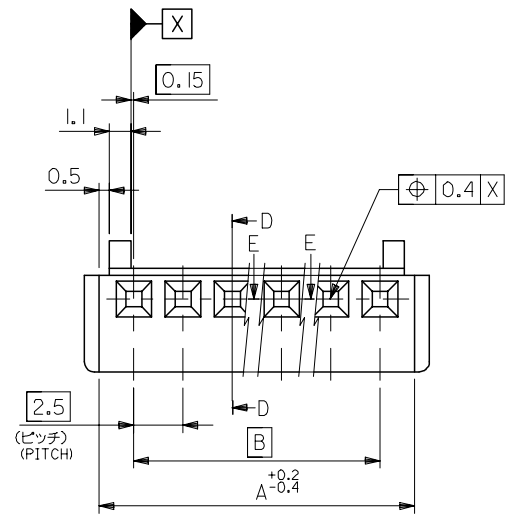

47.5	51	22-01-1204	5102-20	20
45	48.5	▲ -1194	▲ -19	19
42.5	46	-1184	-18	18
40	43.5	-1174	-17	17
37.5	41	-1164	-16	16
35	38.5	-1154	-15	15
32.5	36	-1144	-14	14
30	33.5	-1134	-13	13
27.5	31	-1124	-12	12
25	28.5	-1114	-11	11
22.5	26	-1104	-10	10
20	23.5	-1094	-09	9
17.5	21	-1084	-08	8
15	18.5	-1074	-07	7
12.5	16	-1064	-06	6
10	13.5	-1054	-05	5
7.5	11	-1044	-04	4
5	8.5	▼ -1034	▼ -03	3
2.5	6	22-01-1024	5102-02	2
B	A	EDP. NO.	ENG. NO.	NO. OF EXTS.

注記
NOTE
使用ターミナル: ENG. NO. 5103*
APPLICABLE TERMINAL: ENG. NO. 5103*

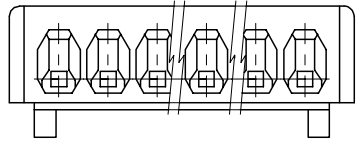

材料
MATERIAL
ナイロン66, UL94V-0
NYLON66, UL94V-0

REVISED EC NO: J2006-3417 DRW: KSAIT001 2006/07/31 CHK: M.TANAKA 2006/08/04 APPR: NUKITA 2006/08/07	GENERAL TOLERANCES (UNLESS SPECIFIED)		DIMENSION STYLE MM ONLY		SCALE 4:1	DESIGN UNITS METRIC	THIRD ANGLE PROJECTION	
	10 UNDER	±0.2	DRAWN BY H. IJIMA		DATE 1996/07/05		TITLE MINI SPOX HSG	
	10 OVER 30 UNDER	±0.25	CHECKED BY M. FUKUSHIMA		DATE 1996/07/05		MOLEX INCORPORATED	
	30 OVER	±0.3	APPROVED BY M. ENOMOTO		DATE 1996/07/05			
	ANGULAR	±3 °	MATERIAL NO. SEE CHART		DOCUMENT NO. SD-5102-001		SHEET NO. 1 OF 1	
DRAFT WHERE APPLICABLE MUST REMAIN WITHIN DIMENSIONS		SIZE A3		THIS DRAWING CONTAINS INFORMATION THAT IS PROPRIETARY TO MOLEX INCORPORATED AND SHOULD NOT BE USED WITHOUT WRITTEN PERMISSION				