

# MC33275, NCV33275

## 300 mA, Low Dropout Voltage Regulator

The MC33275 series are micropower low dropout voltage regulators available in a wide variety of output voltages as well as packages, DPAK, SOT-223, and SOP-8 surface mount packages. These devices feature a very low quiescent current and are capable of supplying output currents up to 300 mA. Internal current and thermal limiting protection are provided by the presence of a short circuit at the output and an internal thermal shutdown circuit.

The MC33275 is available as a MC33375 which includes an On/Off control.

Due to the low input-to-output voltage differential and bias current specifications, these devices are ideally suited for battery powered computer, consumer, and industrial equipment where an extension of useful battery life is desirable.

### Features:

- Low Quiescent Current (125  $\mu$ A)
- Low Input-to-Output Voltage Differential of 25 mV at  $I_O = 10$  mA, and 260 mV at  $I_O = 300$  mA
- Extremely Tight Line and Load Regulation
- Stable with Output Capacitance of only 0.33  $\mu$ F for 2.5 V Output Voltage
- Internal Current and Thermal Limiting

### Simplified Block Diagram

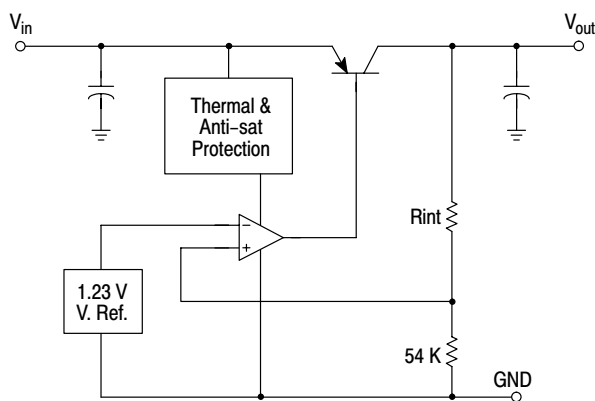

This device contains 41 active transistors



**ON Semiconductor**<sup>®</sup>

<http://onsemi.com>

## LOW DROPOUT MICROPOWER VOLTAGE REGULATOR

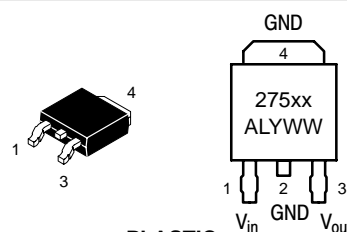

**PLASTIC  
DT SUFFIX  
CASE 369A**

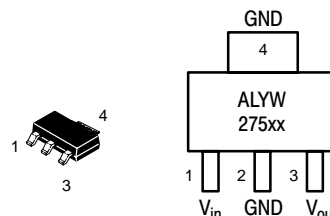

**PLASTIC  
ST SUFFIX  
CASE 318E**

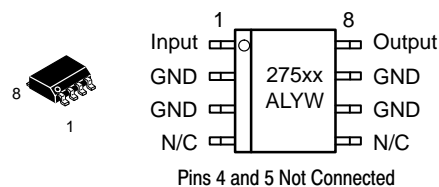

**PLASTIC  
D SUFFIX  
CASE 751**

275 = Specific Device Code  
 xx = Voltage Version  
 A = Assembly Location  
 L = Wafer Lot  
 Y = Year  
 W, WW = Work Week

### ORDERING INFORMATION

See detailed ordering and shipping information in the package dimensions section on page 9 of this data sheet.

# MC33275, NCV33275

## MAXIMUM RATINGS ( $T_A = 25^\circ\text{C}$ , for min/max values $T_J = -40^\circ\text{C}$ to $+125^\circ\text{C}$ )

Rating	Symbol	Value	Unit
Input Voltage	$V_{CC}$	13	Vdc
Power Dissipation and Thermal Characteristics $T_A = 25^\circ\text{C}$			
Maximum Power Dissipation	$P_D$	Internally Limited	W
Case 751 (SOP-8) D Suffix			
Thermal Resistance, Junction-to-Ambient	$R_{\theta JA}$	160	$^\circ\text{C/W}$
Thermal Resistance, Junction-to-Case	$R_{\theta JC}$	25	$^\circ\text{C/W}$
Case 369A (DPAK) DT Suffix			
Thermal Resistance, Junction-to-Air	$R_{\theta JA}$	92	$^\circ\text{C/W}$
Thermal Resistance, Junction-to-Case	$R_{\theta JC}$	6.0	$^\circ\text{C/W}$
Case 318E (SOT-223) ST Suffix			
Thermal Resistance, Junction-to-Air	$R_{\theta JA}$	245	$^\circ\text{C/W}$
Thermal Resistance, Junction-to-Case	$R_{\theta JC}$	15	$^\circ\text{C/W}$
Output Current	$I_O$	300	mA
Maximum Junction Temperature	$T_J$	150	$^\circ\text{C}$
Operating Junction Temperature Range	$T_J$	-40 to +125	$^\circ\text{C}$
Storage Temperature Range	$T_{stg}$	-65 to +150	$^\circ\text{C}$

## ELECTRICAL CHARACTERISTICS ( $C_L = 1.0 \mu\text{F}$ , $T_A = 25^\circ\text{C}$ , for min/max values $T_J = -40^\circ\text{C}$ to $+125^\circ\text{C}$ , Note 1)

Characteristic	Symbol	Min	Typ	Max	Unit	
Output Voltage 2.5 V Suffix 3.0 V Suffix 3.3 V Suffix 5.0 V Suffix	$I_O = 0 \text{ mA to } 250 \text{ mA}$ $T_A = 25^\circ\text{C}$ , $V_{in} = [V_O + 1] \text{ V}$	$V_O$	2.475 2.970 3.267 4.950	2.50 3.00 3.30 5.00	2.525 3.030 3.333 5.05	Vdc
2.5 V Suffix 3.0 V Suffix 3.3 V Suffix 5.0 V Suffix	$V_{in} = [V_O + 1] \text{ V}$ , $0 < I_O < 100 \text{ mA}$ 2% Tolerance from $T_J = -40$ to $+125^\circ\text{C}$		2.450 2.940 3.234 4.900	- - - -	2.550 3.060 3.366 5.100	
Line Regulation	$V_{in} = [V_O + 1] \text{ V to } 12 \text{ V}$ , $I_O = 250 \text{ mA}$ , All Suffixes $T_A = 25^\circ\text{C}$	Reg <sub>line</sub>	-	2.0	10	mV
Load Regulation	$V_{in} = [V_O + 1] \text{ V}$ , $I_O = 0 \text{ mA to } 250 \text{ mA}$ , All Suffixes $T_A = 25^\circ\text{C}$	Reg <sub>load</sub>	-	5.0	25	mV
Dropout Voltage $I_O = 10 \text{ mA}$ $I_O = 100 \text{ mA}$ $I_O = 250 \text{ mA}$ $I_O = 300 \text{ mA}$	$T_J = -40^\circ\text{C to } +125^\circ\text{C}$	$V_{in} - V_O$	- - - -	25 115 220 260	100 200 400 500	mV
Ripple Rejection (120 Hz)	$V_{in(\text{peak-peak})} = [V_O + 1.5] \text{ V to } [V_O + 5.5] \text{ V}$	-	65	75	-	dB
Output Noise Voltage $C_L = 1 \mu\text{F}$ $C_L = 200 \mu\text{F}$	$I_O = 50 \text{ mA}$ (10 Hz to 100 kHz)	$V_n$	- -	160 46	- -	$\mu\text{V}_{rms}$ s

## CURRENT PARAMETERS

Characteristic	Symbol	Min	Typ	Max	Unit	
Quiescent Current ON Mode	$V_{in} = [V_O + 1] \text{ V}$ , $I_O = 0 \text{ mA}$	$I_Q$	-	125	200	$\mu\text{A}$
Quiescent Current ON Mode SAT 2.5 V Suffix 3.0 V Suffix 3.3 V Suffix 5.0 V Suffix	$V_{in} = [V_O - 0.5] \text{ V}$ , $I_O = 0 \text{ mA}$ , Note 2	$I_Q$	- - - -	1100 1500 1500 1500	1500 2000 2000 2000	$\mu\text{A}$
Current Limit	$V_{in} = [V_O + 1] \text{ V}$ , $V_O$ Shorted	$I_{LIMIT}$	-	450	-	mA

## THERMAL SHUTDOWN

Characteristic	Symbol	Min	Typ	Max	Unit
Thermal Shutdown	-	-	150	-	$^\circ\text{C}$

- Low duty pulse techniques are used during test to maintain junction temperature as close to ambient as possible.
- Quiescent Current is measured where the PNP pass transistor is in saturation.  $V_{in} = [V_O - 0.5] \text{ V}$  guarantees this condition.
- NCV prefix is qualified for automotive use.

## DEFINITIONS

**Load Regulation** – The change in output voltage for a change in load current at constant chip temperature.

**Dropout Voltage** – The input/output differential at which the regulator output no longer maintains regulation against further reductions in input voltage. Measured when the output drops 100 mV below its nominal value (which is measured at 1.0 V differential), dropout voltage is affected by junction temperature, load current and minimum input supply requirements.

**Output Noise Voltage** – The RMS AC voltage at the output with a constant load and no input ripple, measured over a specified frequency range.

**Maximum Power Dissipation** – The maximum total dissipation for which the regulator will operate within specifications.

**Quiescent Current** – Current which is used to operate the regulator chip and is not delivered to the load.

**Line Regulation** – The change in output voltage for a change in the input voltage. The measurement is made under conditions of low dissipation or by using pulse techniques such that the average chip temperature is not significantly affected.

**Maximum Package Power Dissipation** – The maximum package power dissipation is the power dissipation level at which the junction temperature reaches its maximum value i.e. 150°C. The junction temperature is rising while the

difference between the input power ( $V_{CC} \times I_{CC}$ ) and the output power ( $V_{out} \times I_{out}$ ) is increasing.

Depending on ambient temperature, it is possible to calculate the maximum power dissipation and so the maximum current as following:

$$P_d = \frac{T_J - T_A}{R_{\theta JA}}$$

The maximum operating junction temperature  $T_J$  is specified at 150°C, if  $T_A = 25^\circ\text{C}$ , then  $P_D$  can be found. By neglecting the quiescent current, the maximum power dissipation can be expressed as:

$$I_{out} = \frac{P_D}{V_{CC} - V_{out}}$$

The thermal resistance of the whole circuit can be evaluated by deliberately activating the thermal shutdown of the circuit (by increasing the output current or raising the input voltage for example).

Then you can calculate the power dissipation by subtracting the output power from the input power. All variables are then well known: power dissipation, thermal shutdown temperature (150°C for MC33275) and ambient temperature.

$$R_{\theta JA} = \frac{T_J - T_A}{P_D}$$

# MC33275, NCV33275

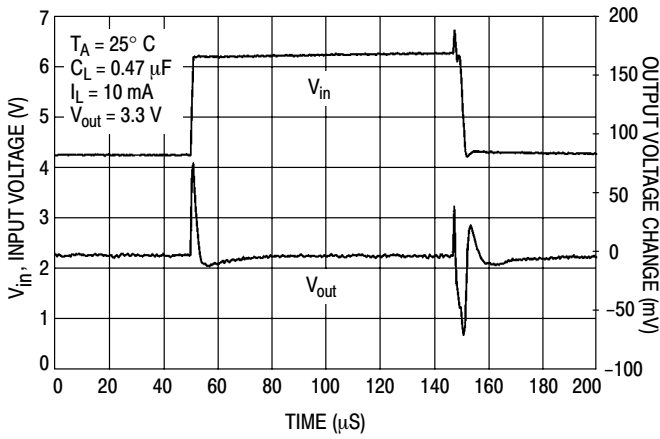

Figure 1. Line Transient Response

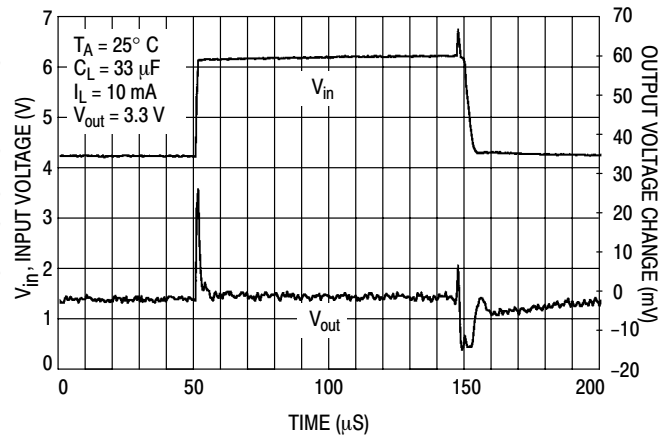

Figure 2. Line Transient Response

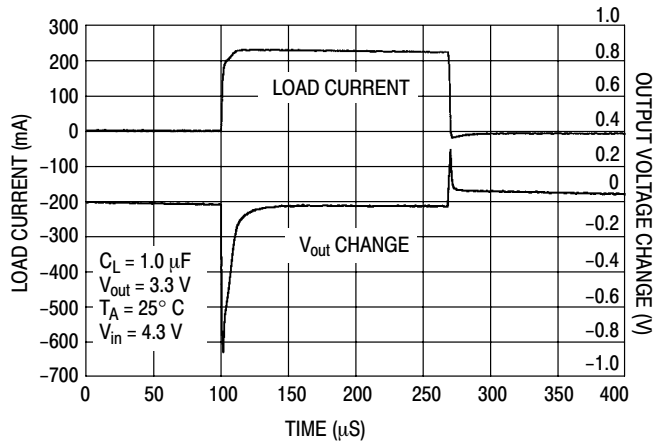

Figure 3. Load Transient Response

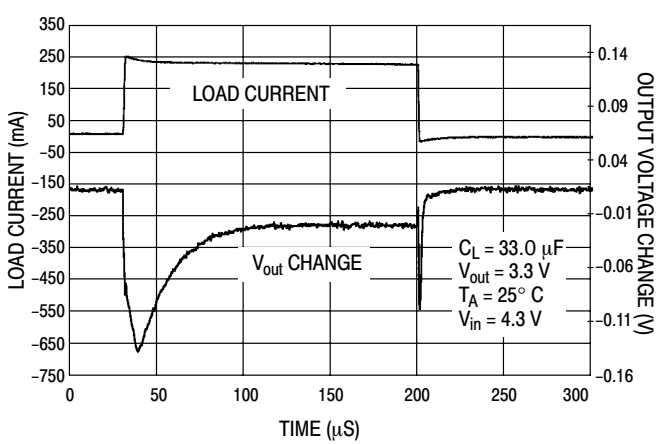

Figure 4. Load Transient Response

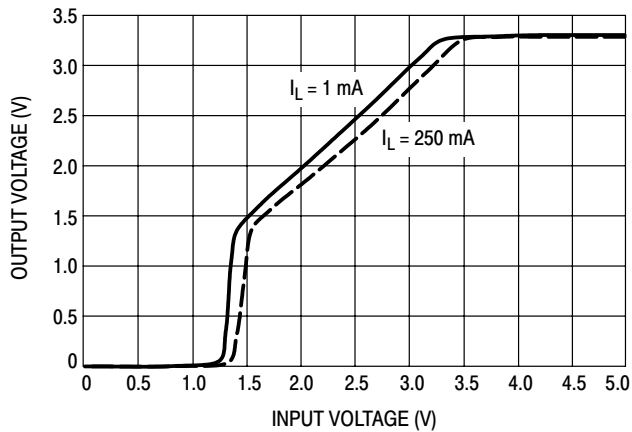

Figure 5. Output Voltage versus Input Voltage

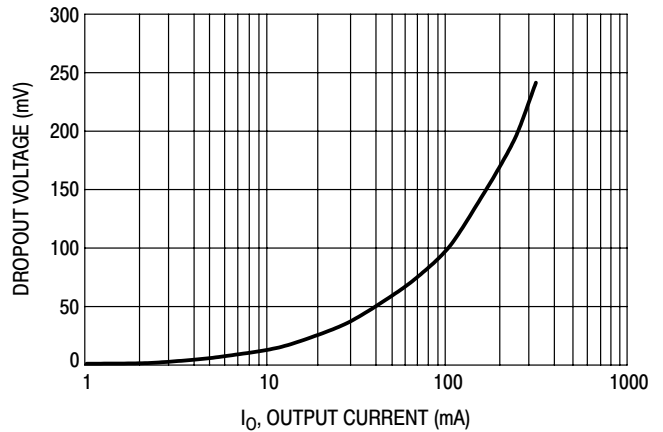

Figure 6. Dropout Voltage versus Output Current

# MC33275, NCV33275

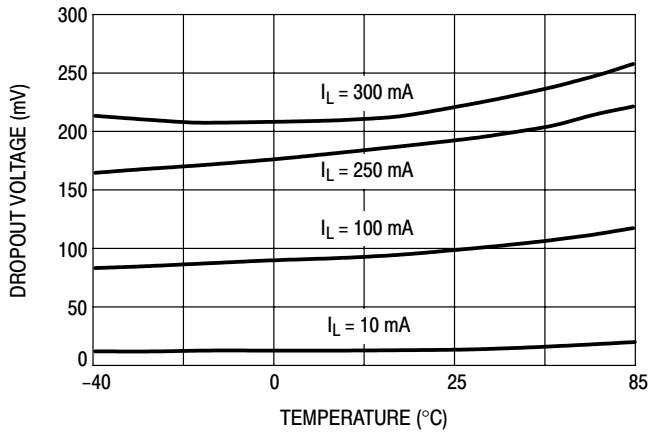

Figure 7. Dropout Voltage versus Temperature

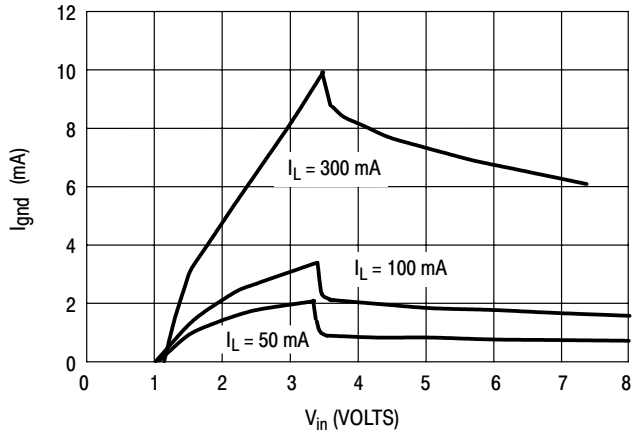

Figure 8. Ground Pin Current versus Input Voltage

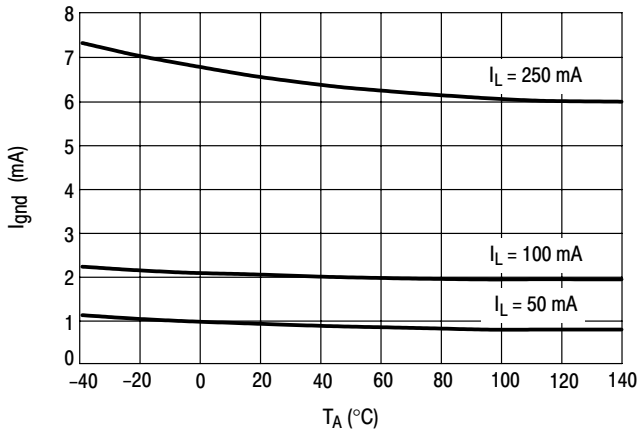

Figure 9. Ground Pin Current versus Ambient Temperature

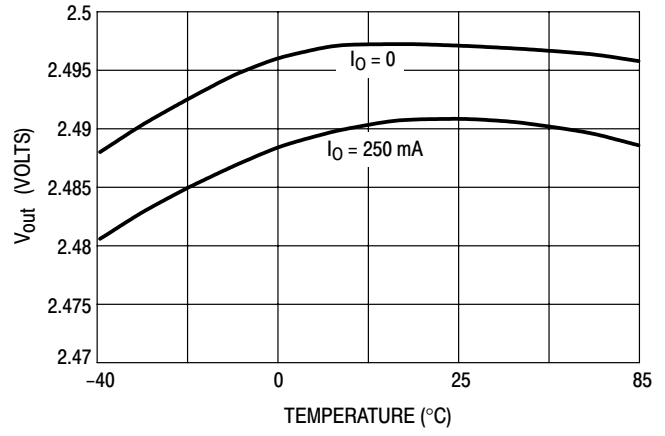

Figure 10. Output Voltage versus Ambient Temperature ( $V_{in} = V_{out1} + 1V$ )

# MC33275, NCV33275

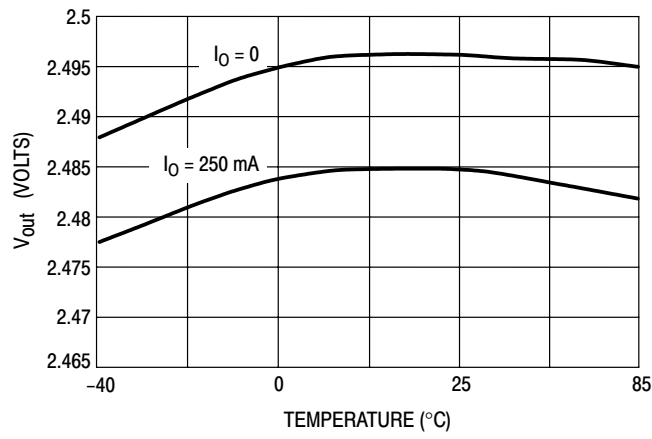

Figure 11. Output Voltage versus Ambient Temperature ( $V_{in} = 12$  V)

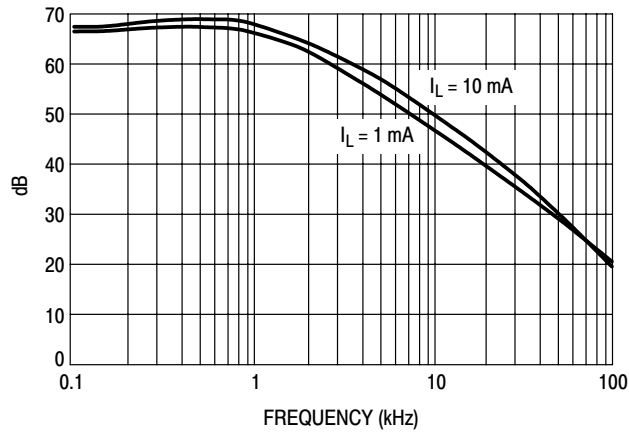

Figure 12. Ripple Rejection

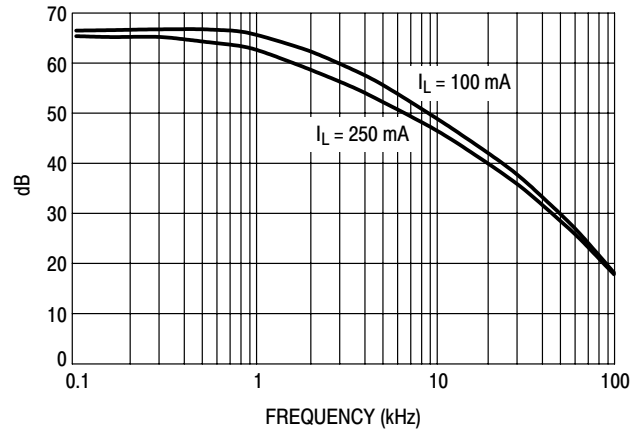

Figure 13. Ripple Rejection

## APPLICATIONS INFORMATION

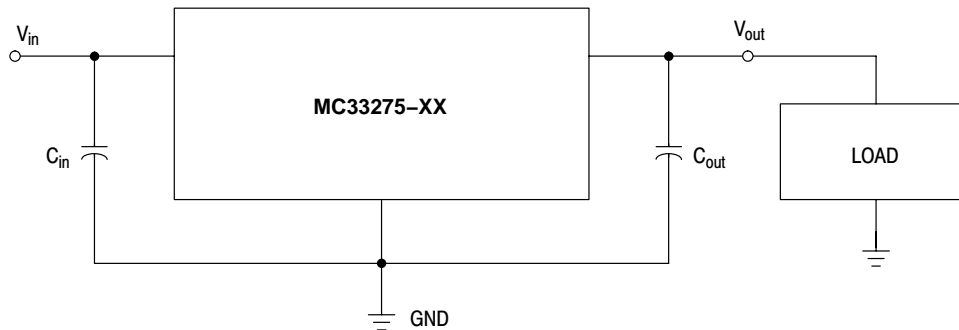
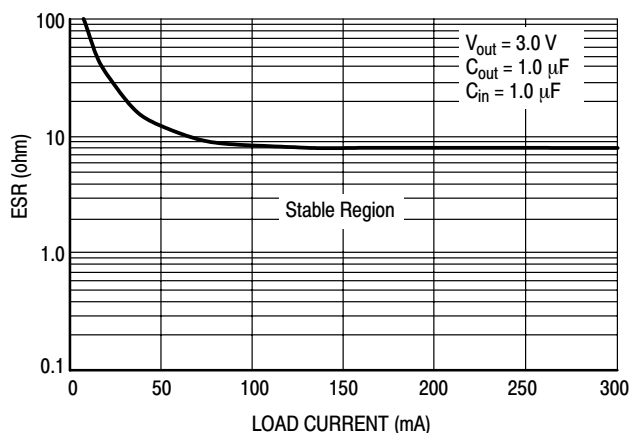

Figure 14. Typical Application Circuit

The MC33275 regulators are designed with internal current limiting and thermal shutdown making them user-friendly. Figure 14 is a typical application circuit. The output capability of the regulator is in excess of 300 mA, with a typical dropout voltage of less than 260 mV. Internal protective features include current and thermal limiting.

**EXTERNAL CAPACITORS**

These regulators require only a 0.33  $\mu\text{F}$  (or greater) capacitance between the output and ground for stability for 2.5 V, 3.0 V, and 3.3 V output voltage options. Output voltage options of 5.0 V require only 0.22  $\mu\text{F}$  for stability. The output capacitor must be mounted as close as possible to the MC33275. If the output capacitor must be mounted further than two centimeters away from the MC33275, then a larger value of output capacitor may be required for stability. A value of 0.68  $\mu\text{F}$  or larger is recommended. Most type of aluminum, tantalum, or multilayer ceramic will perform adequately. Solid tantalums or appropriate multilayer ceramic capacitors are recommended for operation below 25°C. An input bypass capacitor is recommended to improve transient response or if the regulator is connected to the supply input filter with long wire lengths, more than 4 inches. This will reduce the circuit's sensitivity to the input line impedance at high frequencies. A 0.33  $\mu\text{F}$  or larger tantalum, mylar, ceramic, or other capacitor having low internal impedance at high frequencies should be chosen. The bypass capacitor should be mounted with shortest possible lead or track length directly across the regulator's input terminals. Figure 15 shows the ESR that allows the LDO to remain stable for various load currents.

Figure 15. ESR for  $V_{\text{out}} = 3.0\text{V}$ 

**Applications should be tested over all operating conditions to insure stability.**

**THERMAL PROTECTION**

Internal thermal limiting circuitry is provided to protect the integrated circuit in the event that the maximum junction temperature is exceeded. When activated, typically at 150°C, the output is disabled. There is no hysteresis built into the thermal protection. As a result the output will appear to be oscillating during thermal limit. The output will turn off until the temperature drops below the 150°C then the output turns on again. The process will repeat if the junction increases above the threshold. This will continue until the existing conditions allow the junction to operate below the temperature threshold.

**Thermal limit is not a substitute for proper heatsinking.**

The internal current limit will typically limit current to 450 mA. If during current limit the junction exceeds 150°C, the thermal protection will protect the device also. **Current limit is not a substitute for proper heatsinking.**

**OUTPUT NOISE**

In many applications it is desirable to reduce the noise present at the output. Reducing the regulator bandwidth by increasing the size of the output capacitor will reduce the noise on the MC33275.

# MC33275, NCV33275

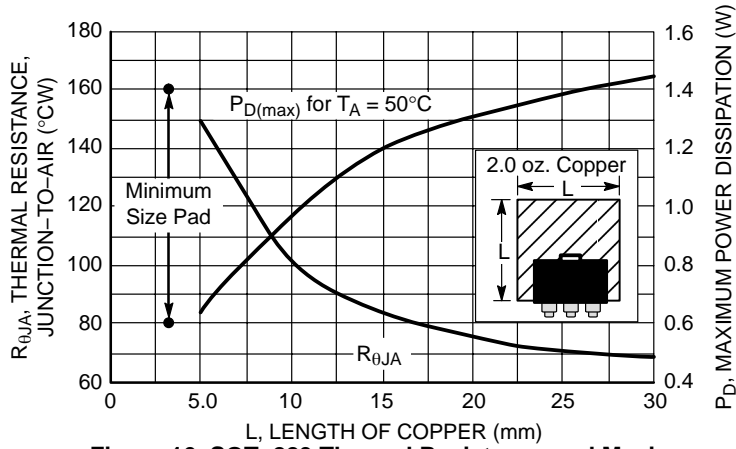

**Figure 16. SOT-223 Thermal Resistance and Maximum Power Dissipation versus P.C.B. Copper Length**

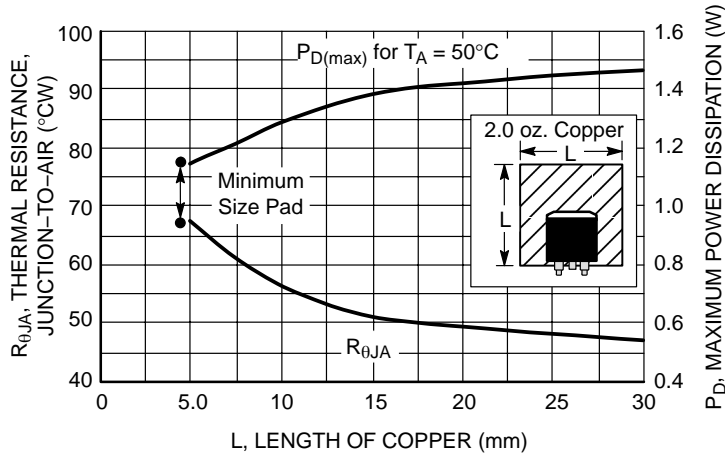

**Figure 17. DPAK Thermal Resistance and Maximum Power Dissipation versus P.C.B. Copper Length**

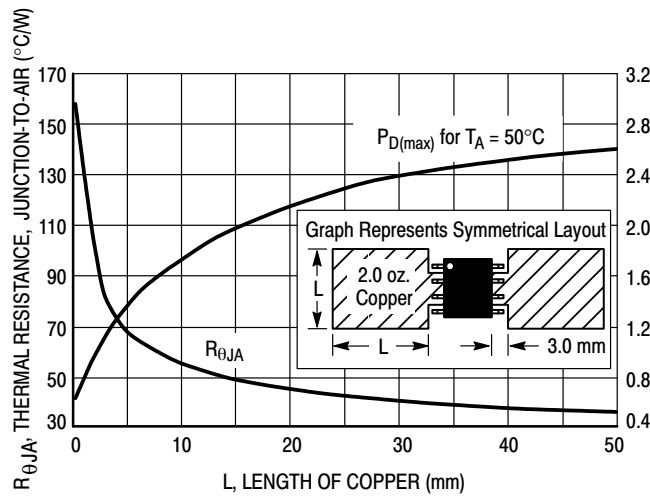

**Figure 18. SOP-8 Thermal Resistance and Maximum Power Dissipation versus P.C.B. Copper Length**



# MC33275, NCV33275

## ORDERING INFORMATION

Device	Type	Operating Temperature Range, Tolerance	Case	Package
MC33275DT-2.5RK	2.5 V (Fixed Voltage)	1% Tolerance at $T_A = 25^\circ\text{C}$  2% Tolerance at $T_J$ from $-40$ to $+125^\circ\text{C}$	369A	DPAK
MC33275ST-2.5T3			318E	SOT-223
MC33275D-2.5R2			751-5	SOP-8
MC33275DT-3.0RK	3.0 V (Fixed Voltage)		369A	DPAK
MC33275ST-3.0T3			318E	SOT-223
MC33275D-3.0R2			751-5	SOP-8
MC33275DT-3.3RK	3.3 V (Fixed Voltage)		369A	DPAK
MC33275ST-3.3T3			318E	SOT-223
MC33275D-3.3R2			751-5	SOP-8
MC33275DT-5.0RK	5.0 V (Fixed Voltage)		369A	DPAK
MC33275ST-5.0T3			318E	SOT-223
NCV33275ST-5.0T3			318E	SOT-223
MC33275D-5.0R2		751-5	SOP-8	

## DEVICE MARKING

Device	Version	Marking (1st line)
MC33275	2.5V	27525
MC33275	3.0V	27530
MC33275	3.3V	27533
MC33275	5.0V	27550

## TAPE AND REEL SPECIFICATIONS

Device	Reel Size	Tape Width	Quantity
MC33275DT	13"	16mm embossed tape	2500 units
MC33275D	13"	12mm embossed tape	2500 units
MC33275S	13"	12mm embossed tape	4000 units

# MC33275, NCV33275

## PACKAGE DIMENSIONS

**ST SUFFIX**  
**PLASTIC PACKAGE**  
**CASE 318E-04**  
**(SOT-223)**  
**ISSUE K**

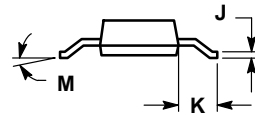
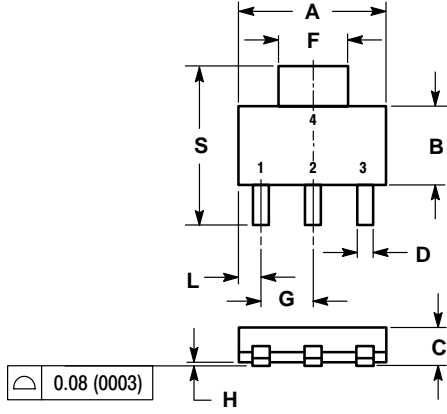

- NOTES:  
 1. DIMENSIONING AND TOLERANCING PER ANSI Y14.5M, 1982.  
 2. CONTROLLING DIMENSION: INCH.

DIM	INCHES		MILLIMETERS	
	MIN	MAX	MIN	MAX
A	0.249	0.263	6.30	6.70
B	0.130	0.145	3.30	3.70
C	0.060	0.068	1.50	1.75
D	0.024	0.035	0.60	0.89
F	0.115	0.126	2.90	3.20
G	0.087	0.094	2.20	2.40
H	0.0008	0.0040	0.020	0.100
J	0.009	0.014	0.24	0.35
K	0.060	0.078	1.50	2.00
L	0.033	0.041	0.85	1.05
M	0°	10°	0°	10°
S	0.264	0.287	6.70	7.30

**D SUFFIX**  
**PLASTIC PACKAGE**  
**CASE 751-07**  
**SOIC-8 NB**  
**ISSUE AA**

SCALE 1:1

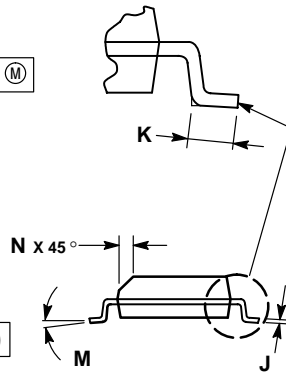
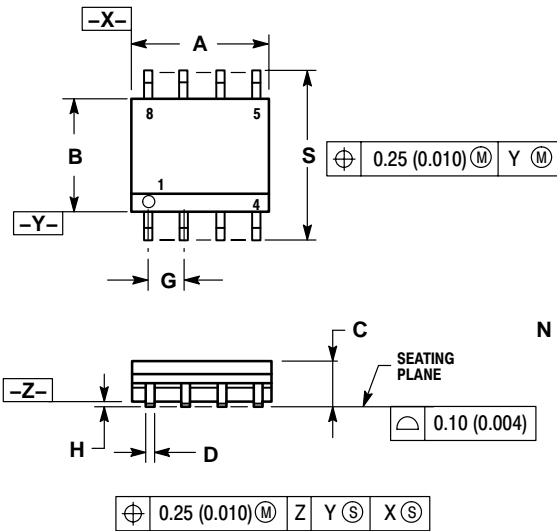

- NOTES:  
 1. DIMENSIONING AND TOLERANCING PER ANSI Y14.5M, 1982.  
 2. CONTROLLING DIMENSION: MILLIMETER.  
 3. DIMENSION A AND B DO NOT INCLUDE MOLD PROTRUSION.  
 4. MAXIMUM MOLD PROTRUSION 0.15 (0.006) PER SIDE.  
 5. DIMENSION D DOES NOT INCLUDE DAMBAR PROTRUSION. ALLOWABLE DAMBAR PROTRUSION SHALL BE 0.127 (0.005) TOTAL IN EXCESS OF THE D DIMENSION AT MAXIMUM MATERIAL CONDITION.  
 6. 751-01 THRU 751-06 ARE OBSOLETE. NEW STANDARD IS 751-07.

DIM	MILLIMETERS		INCHES	
	MIN	MAX	MIN	MAX
A	4.80	5.00	0.189	0.197
B	3.80	4.00	0.150	0.157
C	1.35	1.75	0.053	0.069
D	0.33	0.51	0.013	0.020
G	1.27 BSC		0.050 BSC	
H	0.10	0.25	0.004	0.010
J	0.19	0.25	0.007	0.010
K	0.40	1.27	0.016	0.050
M	0°	8°	0°	8°
N	0.25	0.50	0.010	0.020
S	5.80	6.20	0.228	0.244

# MC33275, NCV33275

## PACKAGE DIMENSIONS

DT SUFFIX  
 PLASTIC PACKAGE  
 CASE 369A-13  
 (DPAK)  
 ISSUE AB

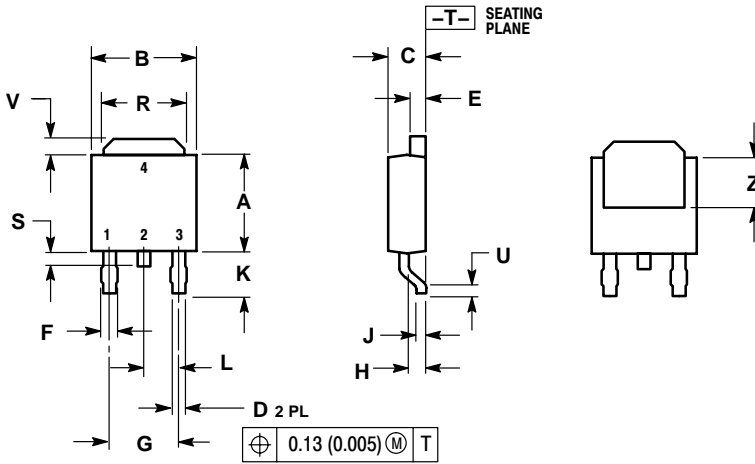

- NOTES:  
 1. DIMENSIONING AND TOLERANCING PER ANSI Y14.5M, 1982.  
 2. CONTROLLING DIMENSION: INCH.

DIM	INCHES		MILLIMETERS	
	MIN	MAX	MIN	MAX
A	0.235	0.250	5.97	6.35
B	0.250	0.265	6.35	6.73
C	0.086	0.094	2.19	2.38
D	0.027	0.035	0.69	0.88
E	0.033	0.040	0.84	1.01
F	0.037	0.047	0.94	1.19
G	0.180 BSC		4.58 BSC	
H	0.034	0.040	0.87	1.01
J	0.018	0.023	0.46	0.58
K	0.102	0.114	2.60	2.89
L	0.090 BSC		2.29 BSC	
R	0.175	0.215	4.45	5.46
S	0.020	0.050	0.51	1.27
U	0.020	---	0.51	---
V	0.030	0.050	0.77	1.27
Z	0.138	---	3.51	---

# MC33275, NCV33275

**ON Semiconductor** and  are registered trademarks of Semiconductor Components Industries, LLC (SCILLC). SCILLC reserves the right to make changes without further notice to any products herein. SCILLC makes no warranty, representation or guarantee regarding the suitability of its products for any particular purpose, nor does SCILLC assume any liability arising out of the application or use of any product or circuit, and specifically disclaims any and all liability, including without limitation special, consequential or incidental damages. "Typical" parameters which may be provided in SCILLC data sheets and/or specifications can and do vary in different applications and actual performance may vary over time. All operating parameters, including "Typicals" must be validated for each customer application by customer's technical experts. SCILLC does not convey any license under its patent rights nor the rights of others. SCILLC products are not designed, intended, or authorized for use as components in systems intended for surgical implant into the body, or other applications intended to support or sustain life, or for any other application in which the failure of the SCILLC product could create a situation where personal injury or death may occur. Should Buyer purchase or use SCILLC products for any such unintended or unauthorized application, Buyer shall indemnify and hold SCILLC and its officers, employees, subsidiaries, affiliates, and distributors harmless against all claims, costs, damages, and expenses, and reasonable attorney fees arising out of, directly or indirectly, any claim of personal injury or death associated with such unintended or unauthorized use, even if such claim alleges that SCILLC was negligent regarding the design or manufacture of the part. SCILLC is an Equal Opportunity/Affirmative Action Employer. This literature is subject to all applicable copyright laws and is not for resale in any manner.

## PUBLICATION ORDERING INFORMATION

### LITERATURE FULFILLMENT:

Literature Distribution Center for ON Semiconductor  
P.O. Box 5163, Denver, Colorado 80217 USA

**Phone:** 303-675-2175 or 800-344-3860 Toll Free USA/Canada

**Fax:** 303-675-2176 or 800-344-3867 Toll Free USA/Canada

**Email:** [orderlit@onsemi.com](mailto:orderlit@onsemi.com)

**N. American Technical Support:** 800-282-9855 Toll Free  
USA/Canada

**Japan:** ON Semiconductor, Japan Customer Focus Center  
2-9-1 Kamimeguro, Meguro-ku, Tokyo, Japan 153-0051  
**Phone:** 81-3-5773-3850

**ON Semiconductor Website:** <http://onsemi.com>

**Order Literature:** <http://www.onsemi.com/litorder>

For additional information, please contact your  
local Sales Representative.