

TAIWAN LITON ELECTRONIC

49E D



8835695 0003846 100 TLIT



LTD-6000 SERIES

T-41-33

0.56" DUAL DIGIT NUMERIC DISPLAYS

FEATURES

- 0.56 INCH (14.2mm) DIGIT HEIGHT.
- CHOICE OF SIX BRIGHT COLORS-RED/BRIGHT RED/GREEN/YELLOW/ORANGE/HIGH EFFICIENCY RED.
- LOW POWER REQUIREMENT.
- EXCELLENT CHARACTERS APPEARANCE.
- CATEGORIZED FOR LUMINOUS INTENSITY.
- I.C. COMPATIBLE.
- EASY MOUNTING ON P.C. BOARD OR SOCKETS.

DESCRIPTION

The LTD-6000, series are 0.56 inch (14.2mm) high, dual digit displays.

The red series devices utilize LED chips which are made from GaAsP on a GaAs substrate. The bright red and green series devices utilize LED chips which are made from GaP on a transparent GaP substrate. The yellow, orange and high efficiency red series devices are utilize LED chips which are made from GaAsP on a transparent GaP substrate. Red and bright red displays have black face and red segment color. Green and yellow displays have gray face and white segment color. Orange displays have orange face and orange segment color. High efficiency red displays have red face and red segment color.

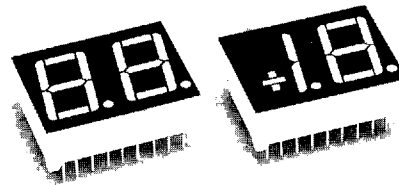

SEVEN-SEGMENT LED DISPLAYS
& ALPHANUMERIC DISPLAYS

DEVICES

PART NO. LTD-						DESCRIPTION	INTERNAL CIRCUIT DIAGRAM
RED	BRIGHT RED	GREEN	YELLOW	ORANGE	HI.-EFF. RED		
6710R	6710P	6410G	6810Y	6610E	6910HR	Common Anode, Rt. Hand Decimal	A
6730R	6730P	6430G	6830Y	6630E	6930HR	Common Anode, ± 1.8 Overflow	B
6740R	6740P	6440G	6840Y	6640E	6940HR	Common Cathode, Rt. Hand Decimal	C
6750R	6750P	6450G	6850Y	6650E	6950HR	Common Cathode, ± 1.8 Overflow	D

PACKAGE DIMENSIONS

LTD-6x10/6x30/6x40/6x50

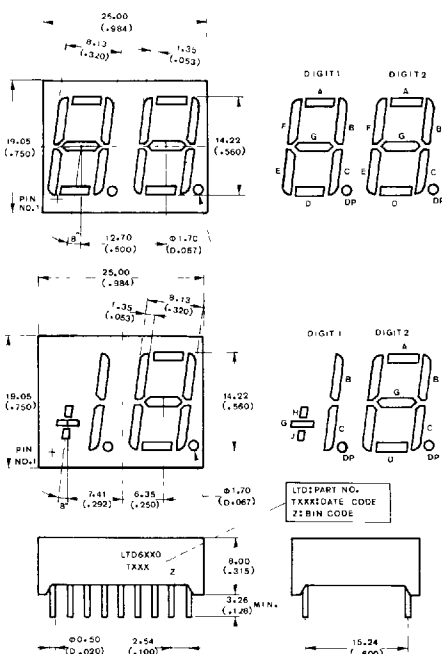

NOTE: All dimensions are in $\frac{\text{millimeters}}{\text{(inches)}}$ tolerance are:

1. Lead length (from seating plane):

$$\text{minimum value} = \frac{+1.00}{-0.00} \text{ mm} = \frac{+0.040''}{-0.000''}$$

2. $\frac{\pm 0.25 \text{ mm}}{(0.010'')}$ unless otherwise noted.

PIN CONNECTION

PIN NO.	CONNECTION			
	A. LTD-6x10	B. LTD-6x30	C. LTD-6x40	D. LTD-6x50
1	Cathode E (Digit 1)	Cathode G (Digit 1)	Anode E (Digit 1)	Anode G (Digit 1)
2	Cathode D (Digit 1)	Cathode J, H (Digit 1)	Anode D (Digit 1)	Anode J, H (Digit 1)
3	Cathode C (Digit 1)	Cathode C (Digit 1)	Anode C (Digit 1)	Anode C (Digit 1)
4	Cathode D P (Digit 1)	Cathode D.P. (Digit 1)	Anode D.P. (Digit 1)	Anode D.P. (Digit 1)
5	Cathode E (Digit 2)	Cathode E (Digit 2)	Anode E (Digit 2)	Anode E (Digit 2)
6	Cathode D (Digit 2)	Cathode D (Digit 2)	Anode D (Digit 2)	Anode D (Digit 2)
7	Cathode G (Digit 2)	Cathode G (Digit 2)	Anode G (Digit 2)	Anode G (Digit 2)
8	Cathode C (Digit 2)	Cathode C (Digit 2)	Anode C (Digit 2)	Anode C (Digit 2)
9	Cathode D.P. (Digit 2)	Cathode D.P. (Digit 2)	Anode D.P. (Digit 2)	Anode D.P. (Digit 2)
10	Cathode B (Digit 2)	Cathode B (Digit 2)	Anode B (Digit 2)	Anode B (Digit 2)
11	Cathode A (Digit 2)	Cathode A (Digit 2)	Anode A (Digit 2)	Anode A (Digit 2)
12	Cathode F (Digit 2)	Cathode F (Digit 2)	Anode F (Digit 2)	Anode F (Digit 2)
13	Common Anode (Digit 2)	Common Anode (Digit 2)	Common Cathode (Digit 2)	Common Cathode (Digit 2)
14	Common Anode (Digit 1)	Common Anode (Digit 1)	Common Cathode (Digit 1)	Common Cathode (Digit 1)
15	Cathode B (Digit 1)	Cathode B (Digit 1)	Anode B (Digit 1)	Anode B (Digit 1)
16	Cathode A (Digit 1)	No Connection	Anode A (Digit 1)	No Connection
17	Cathode G (Digit 1)	No Connection	Anode G (Digit 1)	No Connection
18	Cathode F (Digit 1)	No Connection	Anode F (Digit 1)	No Connection

INTERNAL CIRCUIT DIAGRAM

A. LTD-6x10

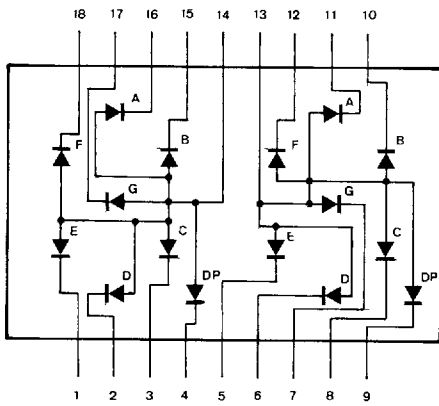

B. LTD-6x30

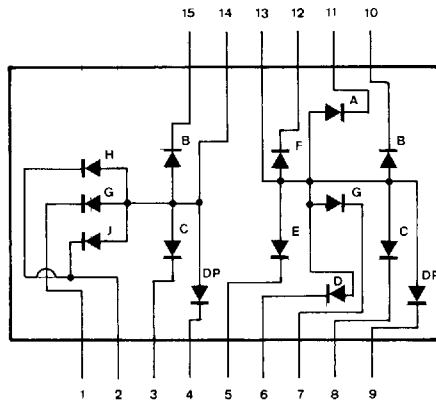

C. LTD-6x40

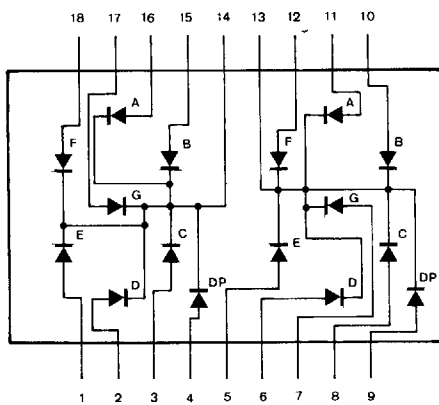

D. LTD-6x50

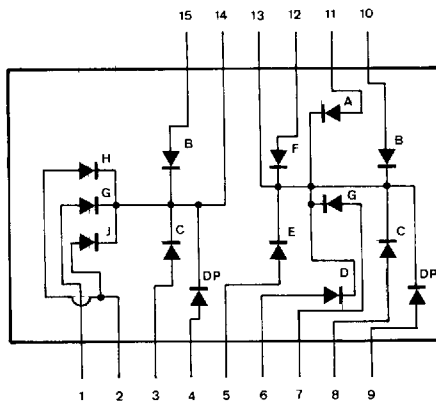

ABSOLUTE MAXIMUM RATINGS AT TA = 25°C

PARAMETER	RED	BRIGHT RED	GREEN	YELLOW	ORANGE	HI-EFF. RED	UNIT
Power Dissipation Per Segment	55	40	75	60	75	75	mW
Peak Forward Current Per Segment (1/10 Duty Cycle, 0.1ms Pulse Width)	160	60	100	80	100	100	mA
Continuous Forward Current Per Segment	25	15	25	20	25	25	mA
Derating Linear From 25°C Per Segment	0.3	0.18	0.3	0.24	0.3	0.3	mA/°C
Reverse Voltage Per Segment	5	5	5	5	5	5	V
Operating Temperature Range	-25°C to +85°C						
Storage Temperature Range	-25°C to +85°C						
Solder Temperature 1/16 inch Below Seating Plane for 3 Seconds at 260°C							

**ELECTRICAL/OPTICAL CHARACTERISTICS AT TA = 25°C
LTD-6700R SERIES**

PARAMETER	SYMBOL	MIN.	TYP.	MAX.	UNIT	TEST CONDITION
Average Luminous Intensity	I_v	200	600		μcd	$I_F = 10 \text{ mA}$
Peak Emission Wavelength	λ_p		655		nm	$I_F = 20 \text{ mA}$
Spectral Line Half-Width	$\Delta\lambda$		24		nm	$I_F = 20 \text{ mA}$
Forward Voltage, any Segment	V_F		1.7	2.0	V	$I_F = 20 \text{ mA}$
Reverse Current, any Segment	I_R			100	μA	$V_R = 5 \text{ V}$
Luminous Intensity Matching Ratio	$I_v\text{-m}$			2:1		$I_F = 20 \text{ mA}$

TYPICAL ELECTRICAL/OPTICAL CHARACTERISTIC CURVES

(25°C Ambient Temperature Unless Otherwise Noted)

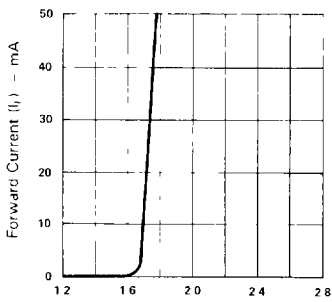

Fig 1 FORWARD CURRENT Vs FORWARD VOLTAGE

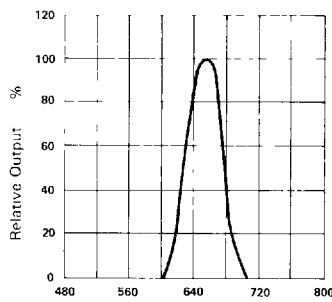

Fig 2 SPECTRAL RESPONSE

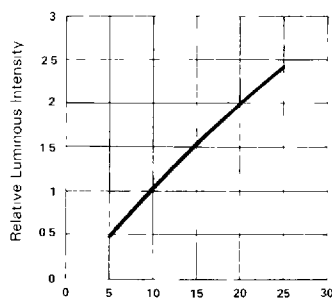

Fig 3 RELATIVE LUMINOUS INTENSITY Vs FORWARD CURRENT (PER SEGMENT)

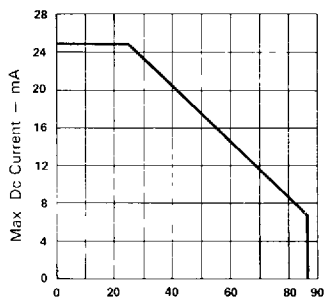

Fig 4 MAX ALLOWABLE DC CURRENT PER SEG Vs AMBIENT TEMPERATURE

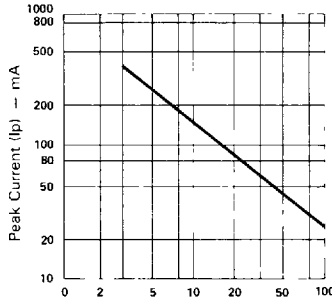

Fig 5 MAX PEAK CURRENT Vs DUTY CYCLE % (REFRESH RATE - F = 1 KHz)

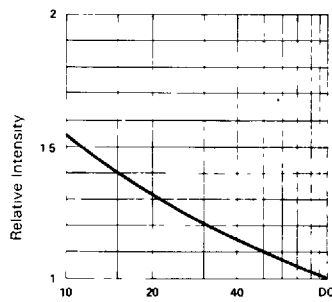

Fig 6 LUMINOUS INTENSITY Vs DUTY CYCLE% (AVERAGE If = 10mA PER SEG)

**ELECTRICAL/OPTICAL CHARACTERISTICS AT TA = 25°C
LTD-6700P SERIES**

PARAMETER	SYMBOL	MIN.	TYP.	MAX.	UNIT	TEST CONDITION
Average Luminous Intensity	Iv	300	950		μcd	IF = 10 mA
Peak Emission Wavelength	λp		697		nm	IF = 20 mA
Spectral Line Half-Width	Δλ		90		nm	IF = 20 mA
Forward Voltage, any Segment	VF		2.1	2.8	V	IF = 20 mA
Reverse Current, any Segment	IR			100	μA	VR = 5 V
Luminous Intensity Matching Ratio	Iv-m			2.1		IF = 20 mA

TYPICAL ELECTRICAL/OPTICAL CHARACTERISTIC CURVES

(25°C Ambient Temperature Unless Otherwise Noted)

SEVEN-SEGMENT LED DISPLAYS
& ALPHANUMERIC DISPLAYS

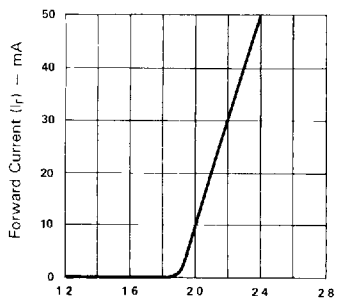

Fig 1 FORWARD CURRENT Vs FORWARD VOLTAGE

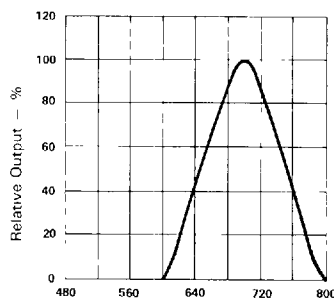

Fig 2 SPECTRAL RESPONSE

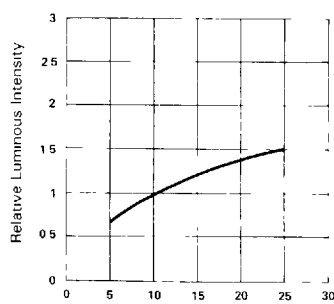

Fig 3 RELATIVE LUMINOUS INTENSITY Vs FORWARD CURRENT (PER SEGMENT)

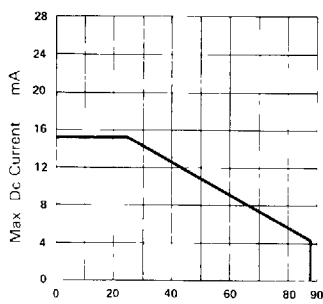

Fig 4 MAX ALLOWABLE DC CURRENT PER SEG Vs AMBIENT TEMPERATURE

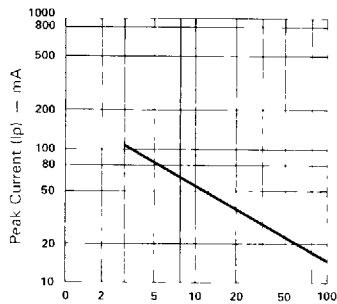

Fig 5 MAX PEAK CURRENT Vs DUTY CYCLE % (REFRESH RATE F = 1 KHz)

**ELECTRICAL/OPTICAL CHARACTERISTICS AT TA = 25°C
LTD-6400G SERIES**

PARAMETER	SYMBOL	MIN.	TYP.	MAX.	UNIT	TEST CONDITION
Average Luminous Intensity	Iv	800	2400		μcd	IF = 10 mA
Peak Emission Wavelength	λp		565		nm	IF = 20 mA
Spectral Line Half-Width	Δλ		30		nm	IF = 20 mA
Forward Voltage, any Segment	VF		2.1	2.8	V	IF = 20 mA
Reverse Current, any Segment	IR			100	μA	VR = 5 V
Luminous Intensity Matching Ratio	Iv-m			2:1		IF = 20 mA

TYPICAL ELECTRICAL/OPTICAL CHARACTERISTIC CURVES

(25°C Ambient Temperature Unless Otherwise Noted)

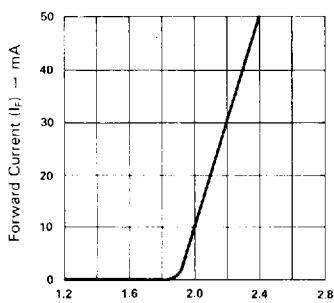

Forward Voltage (V_f) — Volts
Fig. 1 FORWARD CURRENT Vs. FORWARD VOLTAGE.

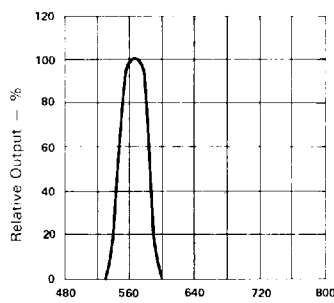

Wavelength (λ) — nm.
Fig. 2 SPECTRAL RESPONSE.

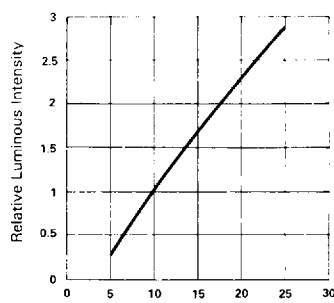

Forward Current (I_f) — mA
Fig. 3 RELATIVE LUMINOUS INTENSITY Vs. FORWARD CURRENT (PER SEGMENT).

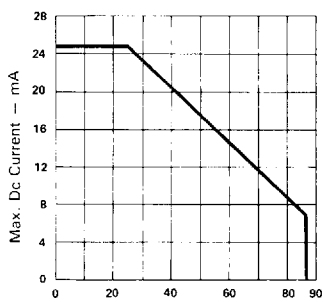

Ambient Temperature (T_a) — °C
Fig. 4 MAX. ALLOWABLE DC CURRENT PER SEG. Vs AMBIENT TEMPERATURE.

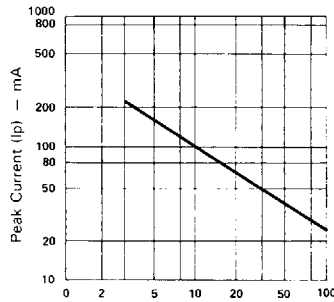

Duty Cycle %
Fig. 5 MAX. PEAK CURRENT Vs. DUTY CYCLE.% (REFRESH RATE F = 1 KHz)

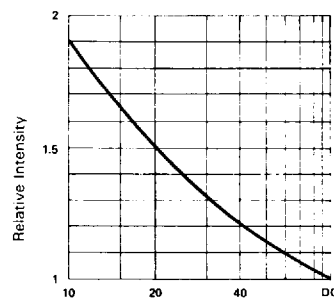

Duty Cycle %
Fig. 6 LUMINOUS INTENSITY Vs. DUTY CYCLE.% (AVERAGE I_f = 10mA PER SEG.)

TAIWAN LITON ELECTRONIC

49E D

8835695

0003852

404 TLIT

**ELECTRICAL/OPTICAL CHARACTERISTICS AT $T_A = 25^\circ\text{C}$
LTD-6800Y SERIES**

PARAMETER	SYMBOL	MIN.	TYP.	MAX.	UNIT	TEST CONDITION
Average Luminous Intensity	I_v	800	2400		μcd	$I_F = 10\text{ mA}$
Peak Emission Wavelength	λ_p		585		nm	$I_F = 20\text{ mA}$
Spectral Line Half-Width	$\Delta\lambda$		35		nm	$I_F = 20\text{ mA}$
Forward Voltage, any Segment	V_F		2.1	2.8	V	$I_F = 20\text{ mA}$
Reverse Current, any Segment	I_R			100	μA	$V_R = 5\text{ V}$
Luminous Intensity Matching Ratio	$I_v\text{-m}$			2:1		$I_F = 20\text{ mA}$

TYPICAL ELECTRICAL/OPTICAL CHARACTERISTIC CURVES

(25°C Ambient Temperature Unless Otherwise Noted)

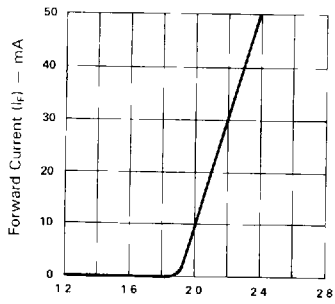

Fig 1 FORWARD CURRENT VS FORWARD VOLTAGE

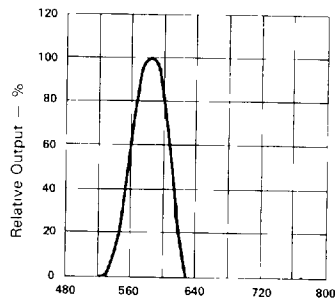

Fig 2 SPECTRAL RESPONSE

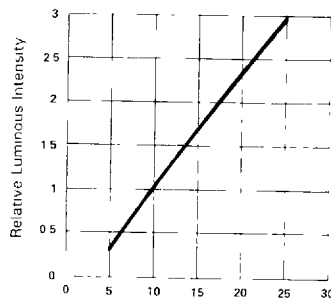

Fig 3 RELATIVE LUMINOUS INTENSITY VS FORWARD CURRENT (PFR SEGMENT)

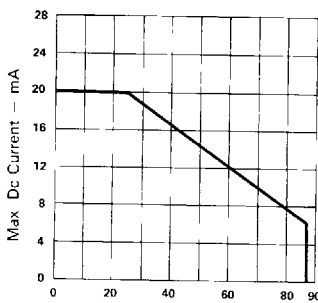

Fig 4 MAX ALLOWABLE DC CURRENT PER SEG VS AMBIENT TEMPERATURE

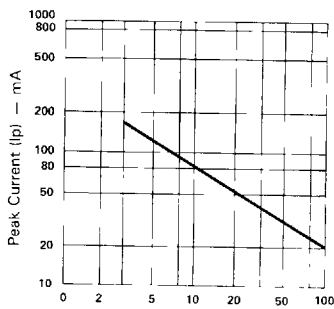

Fig 5 MAX PEAK CURRENT VS DUTY CYCLE % (REFRESH RATE $F = 1\text{ KHz}$)

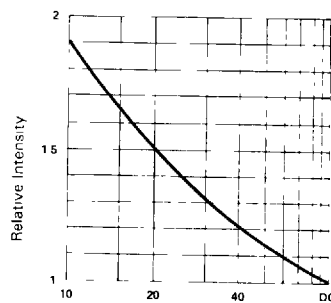

Fig 6 LUMINOUS INTENSITY VS DUTY CYCLE % (AVERAGE $I_f = 10\text{mA PER SEG}$)

SEVEN-SEGMENT LED DISPLAYS
& ALPHANUMERIC DISPLAYS

**ELECTRICAL/OPTICAL CHARACTERISTICS AT TA = 25°C
LTD-6600E SERIES**

PARAMETER	SYMBOL	MIN.	TYP.	MAX.	UNIT	TEST CONDITION
Average Luminous Intensity	I_v	800	2400		μcd	$I_F = 10 \text{ mA}$
Peak Emission Wavelength	λ_p		630		nm	$I_F = 20 \text{ mA}$
Spectral Line Half-Width	$\Delta\lambda$		40		nm	$I_F = 20 \text{ mA}$
Forward Voltage, any Segment	V_R		2.1	2.8	V	$I_F = 20 \text{ mA}$
Reverse Current, any Segment	I_R			100	μA	$V_R = 5 \text{ V}$
Luminous Intensity Matching Ratio	$I_v\text{-m}$			2:1		$I_F = 20 \text{ mA}$

TYPICAL ELECTRICAL/OPTICAL CHARACTERISTIC CURVES

(25°C Ambient Temperature Unless Otherwise Noted)

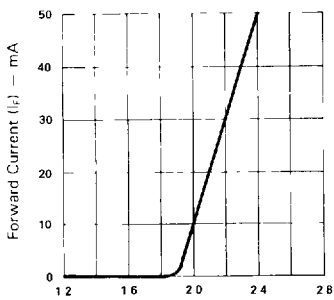

Fig 1 FORWARD CURRENT Vs FORWARD VOLTAGE

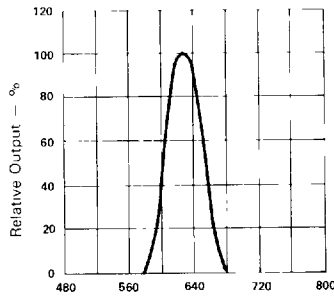

Fig 2 SPECTRAL RESPONSE

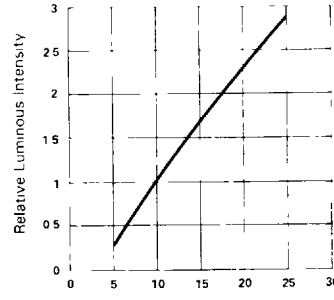

Fig 3 RELATIVE LUMINOUS INTENSITY Vs FORWARD CURRENT (PER SEGMENT)

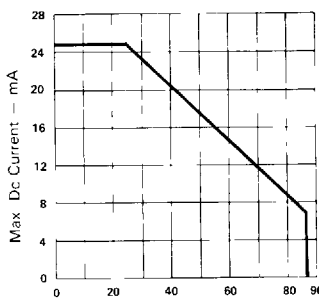

Fig 4 MAX ALLOWABLE DC CURRENT PER SEG Vs AMBIENT TEMPERATURE

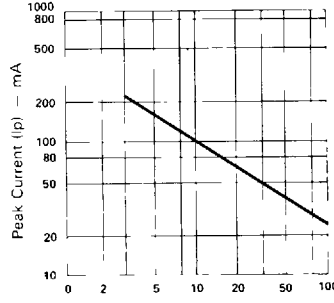

Fig 5 MAX PEAK CURRENT Vs DUTY CYCLE % (REFRESH RATE - F = 1 KHz)

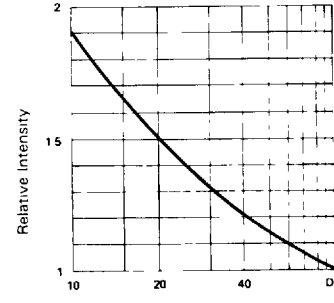

Fig 6 LUMINOUS INTENSITY Vs DUTY CYCLE% (AVERAGE $I_a = 10\text{mA}$ PER SEG)

**ELECTRICAL/OPTICAL CHARACTERISTICS AT $T_A = 25^\circ\text{C}$
LTD-6900HR SERIES**

PARAMETER	SYMBOL	MIN.	TYP.	MAX.	UNIT	TEST CONDITION
Average Luminous Intensity	I_v	800	2400		μcd	$I_F = 10\text{ mA}$
Peak Emission Wavelength	λ_p		635		nm	$I_F = 20\text{ mA}$
Spectral Line Half-Width	$\Delta\lambda$		40		nm	$I_F = 20\text{ mA}$
Forward Voltage, any Segment or D.P.	V_F		2.1	2.8	V	$I_F = 20\text{ mA}$
Reverse Current, any Segment or D.P.	I_R			100	μA	$V_R = 5\text{ V}$
Luminous Intensity Matching Ratio	$I_v\text{-m}$			2:1		$I_F = 20\text{ mA}$

TYPICAL ELECTRICAL/OPTICAL CHARACTERISTIC CURVES

(25°C Ambient Temperature Unless Otherwise Noted)

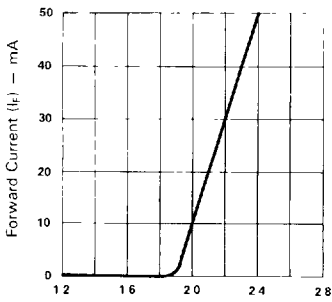

Fig 1 FORWARD CURRENT Vs FORWARD VOLTAGE

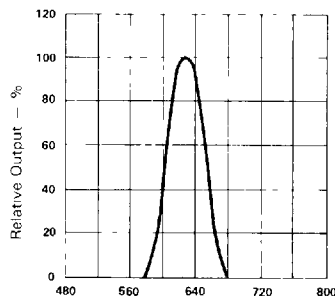

Fig 2 SPECTRAL RESPONSE

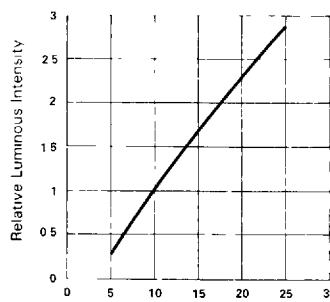

Fig 3 RELATIVE, LUMINOUS INTENSITY vs FORWARD CURRENT (PER SEGMENT)

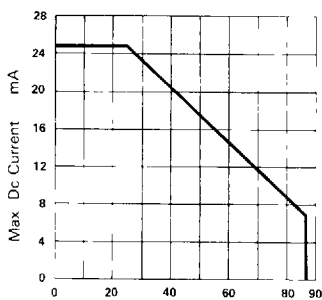

Fig 4 MAX ALLOWABLE DC CURRENT PER SEG Vs AMBIENT TEMPERATURE

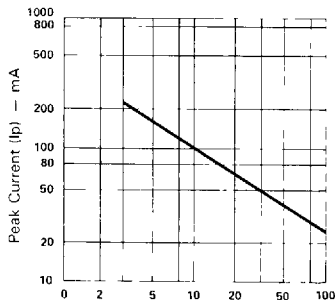

Fig 5 MAX PEAK CURRENT Vs DUTY CYCLE % (REFRESH RATE - F = 1 KHz)

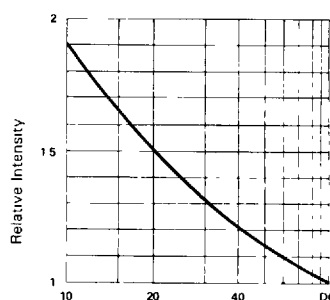

Fig 6 LUMINOUS INTENSITY Vs DUTY CYCLE % (AVERAGE $I_F = 10\text{ mA}$ PER SEG)