

ULTRAFast SOFT RECOVERY RECTIFIER DIODE
PRODUCT APPLICATIONS

- Anti-Parallel Diode
 - Switchmode Power Supply
 - Inverters
- Free Wheeling Diode
 - Motor Controllers
 - Converters
 - Inverters
- Snubber Diode
- PFC
- RoHS Compliant 

PRODUCT FEATURES

- Ultrafast Recovery Times
- Soft Recovery Characteristics
- Popular TO-247 Package or Surface Mount D²PAK Package
- Low Forward Voltage
- Low Leakage Current
- Avalanche Energy Rated

PRODUCT BENEFITS

- Low Losses
- Low Noise Switching
- Cooler Operation
- Higher Reliability Systems
- Increased System Power Density

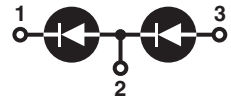
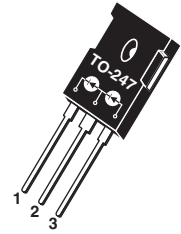

- 1 - Cathode 1
- 2 - Anode 1
Cathode 2
- 3 - Anode 2

MAXIMUM RATINGS

 All Ratings per diode: $T_C = 25^\circ\text{C}$ unless otherwise specified.

| Symbol | Characteristic / Test Conditions | APT30DQ60BHB(G) | UNIT |
|----------------|--|-----------------|-------|
| V_R | Maximum D.C. Reverse Voltage | 600 | Volts |
| V_{RRM} | Maximum Peak Repetitive Reverse Voltage | | |
| V_{RWM} | Maximum Working Peak Reverse Voltage | | |
| $I_{F(AV)}$ | Maximum Average Forward Current ($T_C = 67^\circ\text{C}$, Duty Cycle = 0.5) | 30 | Amps |
| $I_{F(RMS)}$ | RMS Forward Current (Square wave, 50% duty) | 51 | |
| I_{FSM} | Non-Repetitive Forward Surge Current ($T_J = 45^\circ\text{C}$, 8.3ms) | 320 | |
| E_{AVL} | Avalanche Energy (1A, 40mH) | 20 | mJ |
| T_J, T_{STG} | Operating and Storage Temperature Range | -55 to 175 | °C |
| T_L | Lead Temperature for 10 Sec. | 300 | |

STATIC ELECTRICAL CHARACTERISTICS

| Symbol | Characteristic / Test Conditions | MIN | TYP | MAX | UNIT | |
|----------|---|-----|--|-----|------|---------------|
| V_F | Forward Voltage | | $I_F = 30\text{A}$ | 2.0 | 2.4 | Volts |
| | | | $I_F = 60\text{A}$ | 2.4 | | |
| | | | $I_F = 30\text{A}, T_J = 125^\circ\text{C}$ | 1.7 | | |
| I_{RM} | Maximum Reverse Leakage Current | | $V_R = 600\text{V}$ | | 25 | μA |
| | | | $V_R = 600\text{V}, T_J = 125^\circ\text{C}$ | | 500 | |
| C_T | Junction Capacitance, $V_R = 200\text{V}$ | | 36 | | pF | |

DYNAMIC CHARACTERISTICS

APT30DQ60BHB(G)

| Symbol | Characteristic | Test Conditions | MIN | TYP | MAX | UNIT |
|-----------|----------------------------------|--|-----|-----|-----|------|
| t_{rr} | Reverse Recovery Time | $I_F = 1A, di_F/dt = -100A/\mu s, V_R = 30V, T_J = 25^\circ C$ | - | 23 | | ns |
| t_{rr} | Reverse Recovery Time | $I_F = 30A, di_F/dt = -200A/\mu s, V_R = 400V, T_C = 25^\circ C$ | - | 30 | | |
| Q_{rr} | Reverse Recovery Charge | | - | 55 | | nC |
| I_{RRM} | Maximum Reverse Recovery Current | | - | 3 | - | Amps |
| t_{rr} | Reverse Recovery Time | $I_F = 30A, di_F/dt = -200A/\mu s, V_R = 400V, T_C = 125^\circ C$ | - | 175 | | ns |
| Q_{rr} | Reverse Recovery Charge | | - | 485 | | nC |
| I_{RRM} | Maximum Reverse Recovery Current | | - | 6 | - | Amps |
| t_{rr} | Reverse Recovery Time | $I_F = 30A, di_F/dt = -1000A/\mu s, V_R = 400V, T_C = 125^\circ C$ | - | 75 | | ns |
| Q_{rr} | Reverse Recovery Charge | | - | 855 | | nC |
| I_{RRM} | Maximum Reverse Recovery Current | | - | 22 | | Amps |

THERMAL AND MECHANICAL CHARACTERISTICS

| Symbol | Characteristic / Test Conditions | MIN | TYP | MAX | UNIT |
|-----------------|-------------------------------------|-----|------|-----|--------------|
| $R_{\theta JC}$ | Junction-to-Case Thermal Resistance | | | 1.5 | $^\circ C/W$ |
| W_T | Package Weight | | 0.22 | | oz |
| | | | 5.9 | | g |
| Torque | Maximum Mounting Torque | | | 10 | lb•in |
| | | | | 1.1 | N•m |

Microsemi reserves the right to change, without notice, the specifications and information contained herein.

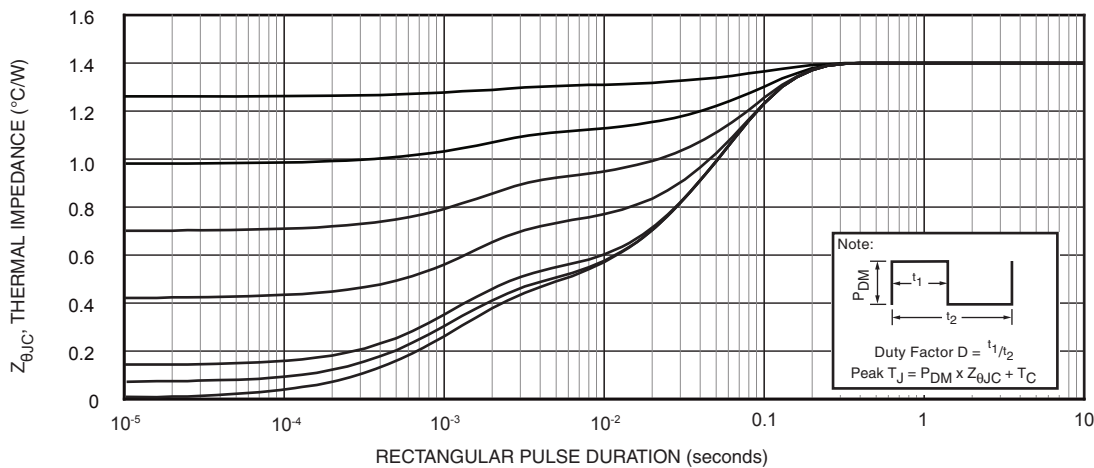

FIGURE 1a. MAXIMUM EFFECTIVE TRANSIENT THERMAL IMPEDANCE, JUNCTION-TO-CASE vs. PULSE DURATION

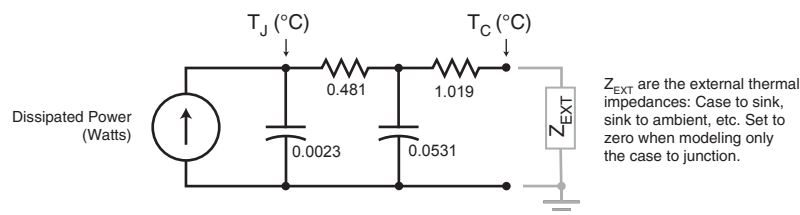

FIGURE 1b. TRANSIENT THERMAL IMPEDANCE MODEL

TYPICAL PERFORMANCE CURVES

APT30DQ60BHB(G)

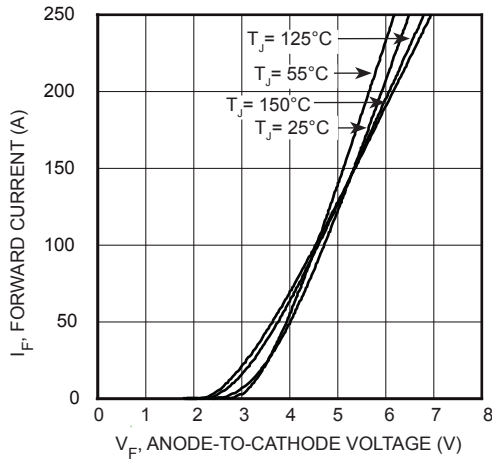

FIGURE 2, Forward Current vs. Forward Voltage

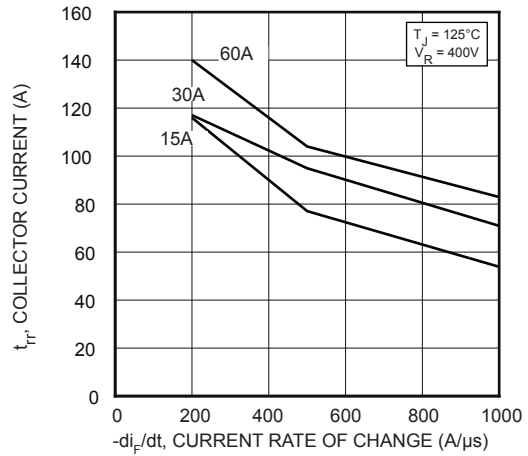

FIGURE 3, Reverse Recovery Time vs. Current Rate of Change

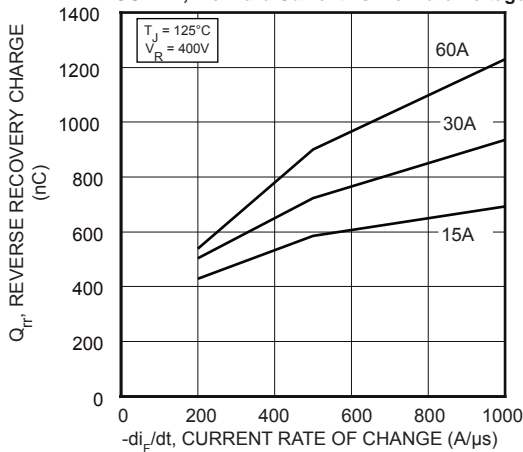

FIGURE 4, Reverse Recovery Charge vs. Current Rate of Change

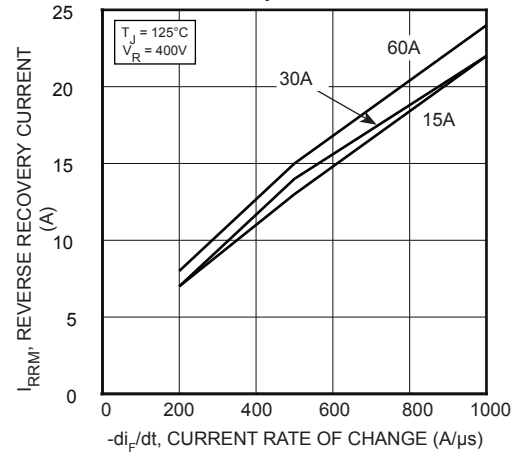

FIGURE 5, Reverse Recovery Current vs. Current Rate of Change

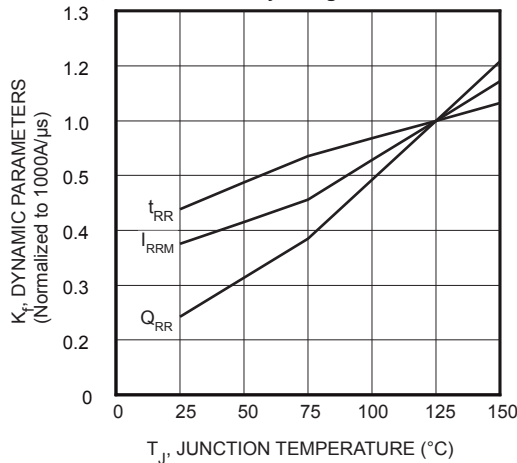

FIGURE 6, Dynamic Parameters vs. Junction Temperature

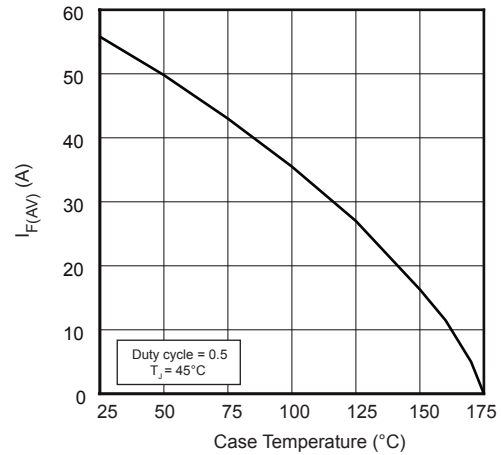

FIGURE 7, Maximum Average Forward Current vs. Case Temperature

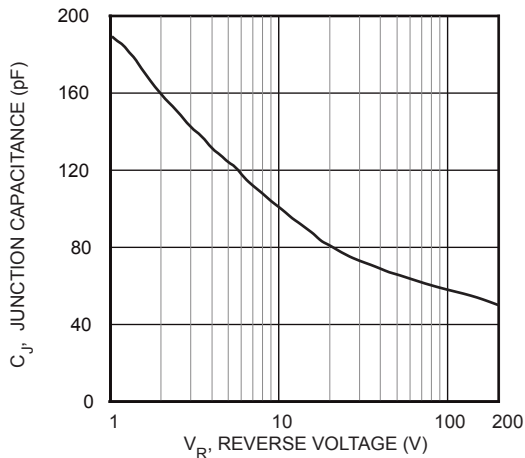

FIGURE 8, Junction Capacitance vs. Reverse Voltage

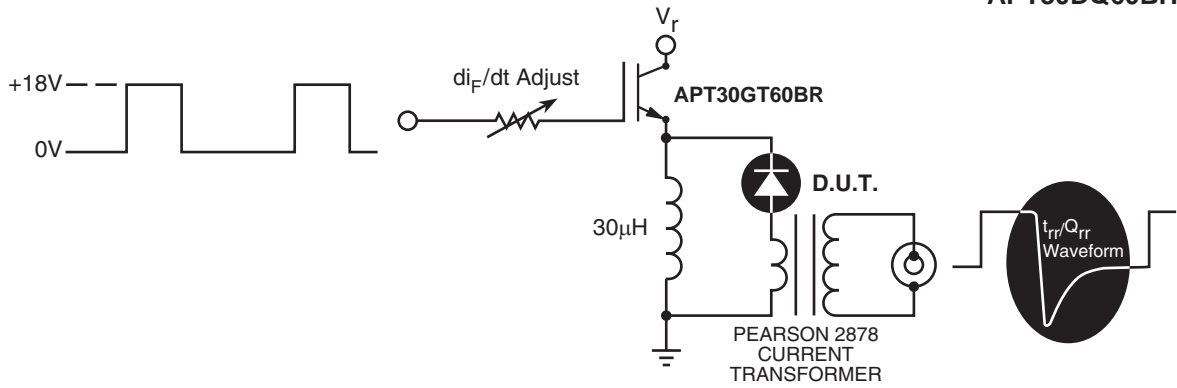

Figure 9. Diode Test Circuit

- 1 I_F - Forward Conduction Current
- 2 di_F/dt - Rate of Diode Current Change Through Zero Crossing.
- 3 I_{RRM} - Maximum Reverse Recovery Current.
- 4 t_{rr} - Reverse Recovery Time, measured from zero crossing where diode current goes from positive to negative, to the point at which the straight line through I_{RRM} and $0.25 \cdot I_{RRM}$ passes through zero.
- 5 Q_{rr} - Area Under the Curve Defined by I_{RRM} and t_{rr} .

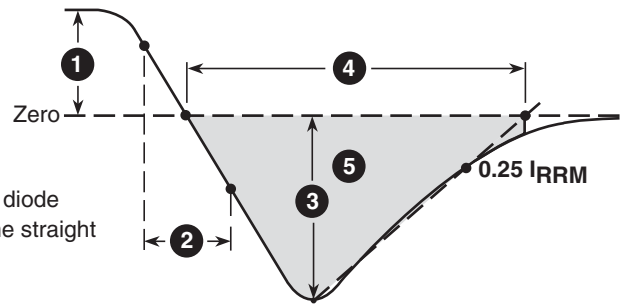

Figure 10, Diode Reverse Recovery Waveform and Definitions

TO-247 Package Outline

e1 SAC: Tin, Silver, Copper

