

## TRIACS FOR MICROWAVE OVEN

P. RAULT

Triacs are now commonly used in microwave ovens as static switches to control the power transformer, the heating resistor for grill and sometimes the motor for plate rotation.

The conditions of operation of triacs for transformer control and for heater control are analysed here after in order to select the suitable device, to define the gate drive circuit and to implement an efficient protection.

### I . POWER TRANSFORMER CONTROL :

The magnetron of a microwave oven is generally supplied by rectified high voltage obtained with a 50/60 Hz transformer. The power supplied to the oven is controlled by a triac in series with the primary (fig.1).

to limit the overcurrent by using a proper triggering synchronization.

### Transient operation in inductive circuit with iron core :

During continuous operation, the magnetic field H, proportional to the current in the coil, generates an induction B in the iron core with a delay as shown by the hysteresis cycle in figure 2A.

In transient operation, the induction can follow a different path and reach the saturation value BS for which the magnetic field H (according to the coil current) increases very rapidly (Fig.2B).

**Figure 1** : Magnetron power supply controlled by a triac.

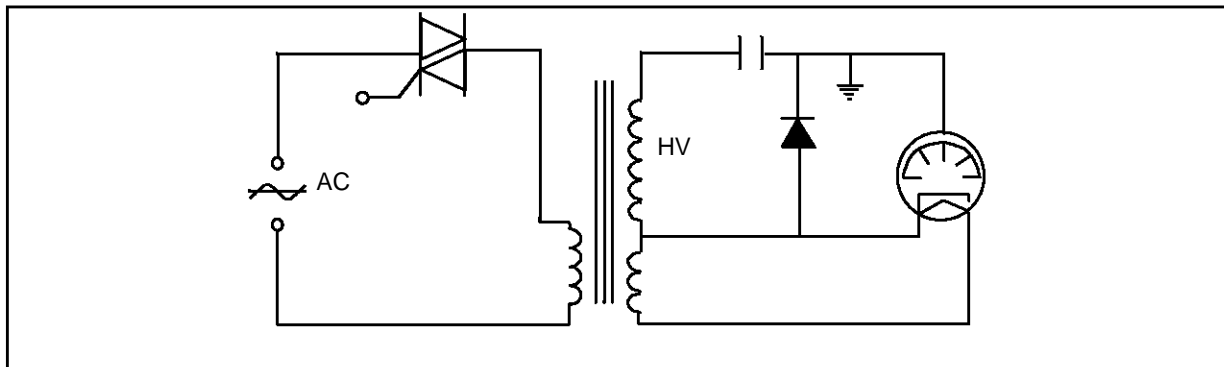

### 1/ Current stresses :

The power to be controlled is typically 1 to 2 KW and the nominal RMS current is in the range of 10 to 16 Amp according to the line voltage but it is necessary to take into account an overload due to the magnetizing current through the transformer at turn on.

Due to the high turns ratio of this transformer this overcurrent can reach a peak up to 20 times the RMS current in steady state !

To reduce the stresses at every switching on the circuit and particularly on the triac it is important

## APPLICATION NOTE

**Figure 2 :** A Magnetic field H versus induction B  
(continuous rating)  
B Saturation induction BS

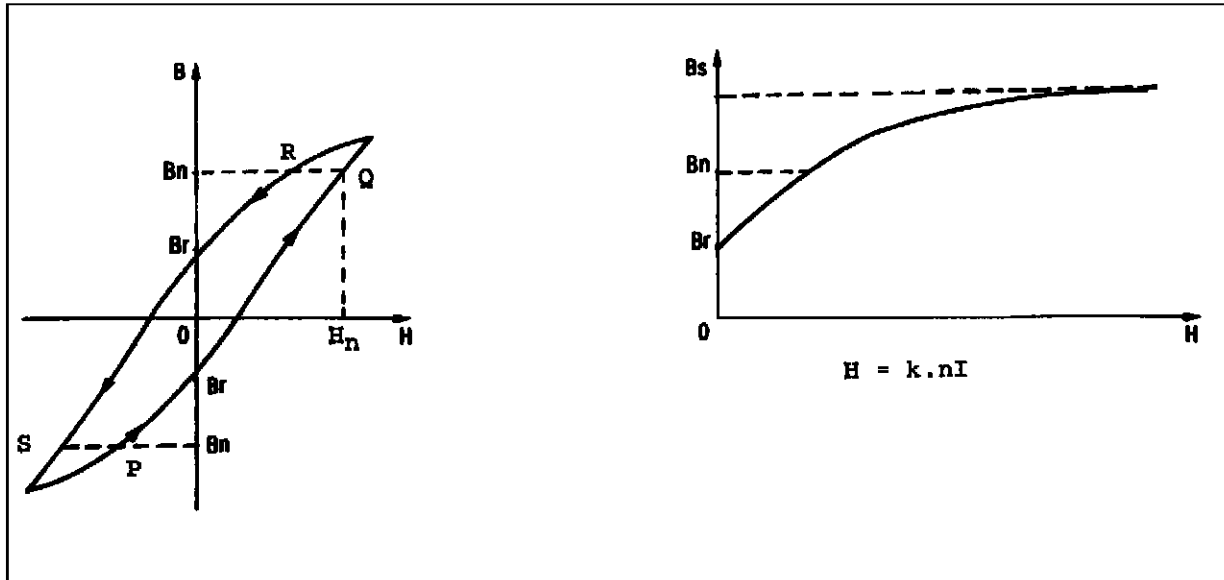

$$B_{max} = 2 B_n - B_r.$$

In the circuits controlled by a triac, switching OFF occurs when the current is at zero. Thus the induction has a remanent value  $B_r$  (positive or negative), corresponding to  $H = 0$  (Fig.2A).

The overload is lower than previously but still remains high (Fig.3B).

When the triac begins to conduct, the transient current depends on the instant of synchronization of the control signal with respect to the mains voltage.

### FIRING AT ZERO MAINS VOLTAGE :

Peak induction tends to the value :

$$B_{max} = 2 B_n + B_r$$

Thus in most cases B reaches the saturation induction  $B_s$ . The amplitude of the current proportional to the magnetic field H becomes very high ; this type of control produces the highest transient overloads (Fig.3A).

In this case the transformer behaves like a short circuit and peak current is limited only by the series resistances of this circuit.

Nevertheless it is possible to reduce the overcurrent if control at zero voltages done by complete cycles i-e the polarity at the moment of firing is the reverse of that at moment the circuit is switched OFF.

Peak induction thus reaches the value :

Figure 3 : Transient induction and current at beginning of conduction.

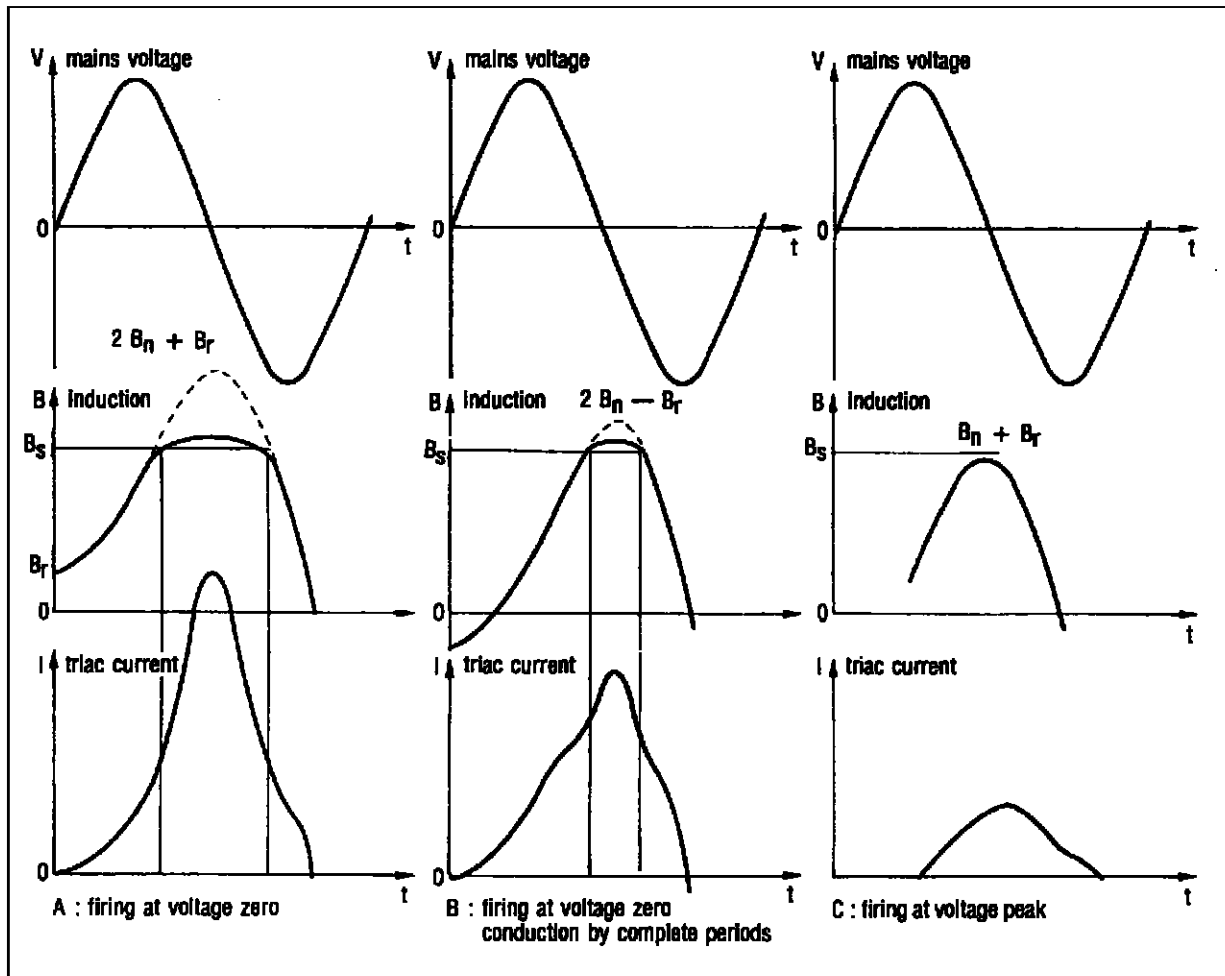

FIRING AT PEAK MAINS VOLTAGE :

In this case the peak induction takes the value :  
 $B_{max} = B_n + B_r$   
 The level of saturation is not reached and amplitude of the current remains within acceptable limits (Fig.3c).  
 → This type of synchronization must be used for transformer control.  
 See in appendix actual oscillogrammes of current through a transformer for different synchronization modes.

Figure 4 : A gate control by single pulse synchronized with zero current  
 B gate control by pulse train.

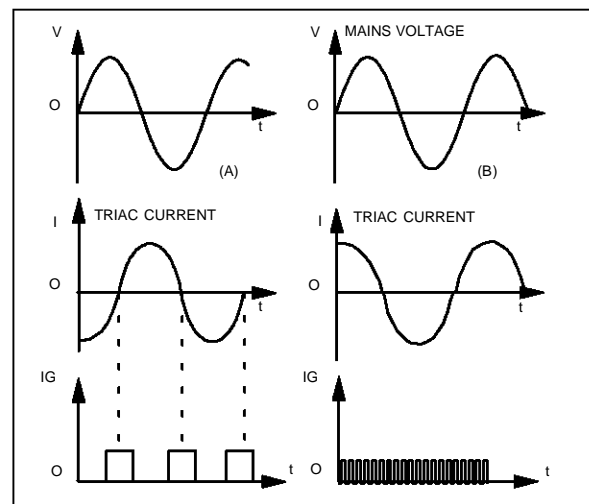

## APPLICATION NOTE

### 2/ Gate control :

After the first firing the gate pulse should be synchronized with the triac current zero point (Fig.4A).

The pulse duration must be sufficient to be sure the main current through the circuit reaches the triac latching current.(IL)

A pulse train can be used to avoid the problem of misfiring or wrong synchronization (Fig.4b).

A frequency of several kilohertz guarantees a correct operation.

Gate control by DC current is also an efficient method to keep the triac on in case of inductive load.

To reduce the consumption of this kind of trigger circuit a sensitive triac can be used as a driver (Fig.5).

**Figure 5 :** Use of sensitive triac (5 mA) as driver to reduce gate control circuit consumption.

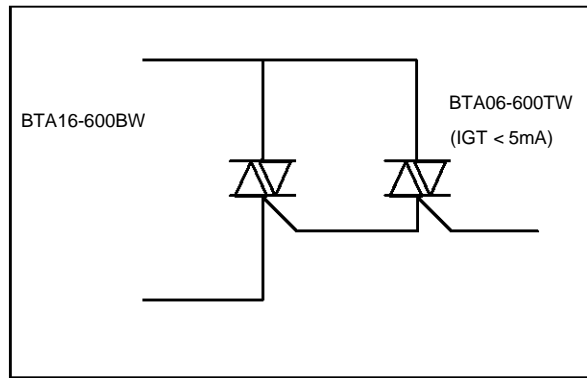

### 3/ Protection :

It is important to avoid as much as possible all risk of misfiring of triac specially by overvoltage. Transient voltages can be generated by internal mechanical switches used for security system (door, overbreak protection etc ....) or superimposed to the line voltage. These last ones must be attenuated by a filter at the input. An efficient protection at the triac level consists in use of TRANSIL diode across the triac to clamp the spikes higher than its voltage ratings ( $V_{DRM}$ ) associated with our RC network to limit the off state dv/dt under the specified value . (Fig.6)

**Figure 6 :** TRANSIL diode and RC network are necessary to prevent spurious firing by overvoltages and/or dv/dt.

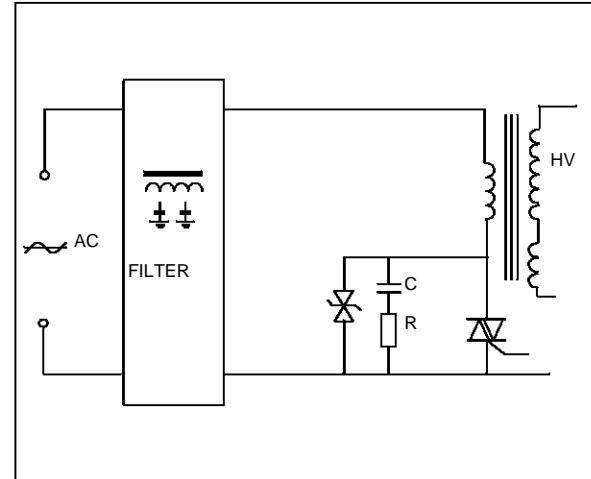

Nevertheless one accidental misfiring is always possible and in this case the triac must be able to hold the surge current. Therefore it is necessary to select a device with a sufficient ITSM (max peak current for 10 ms) for example 120 to 250 Amp.

### 4/ Preferred devices :

#### - Current ratings :

The nominal RMS current through the circuit is not the main criteria but the surge current capability. We suggest the following current ranges.

$I_{TRMS} = 12 \text{ A}$  with  $I_{TSM} = 120 \text{ A}$

$I_{TRMS} = 16 \text{ A}$  with  $I_{TSM} = 160 \text{ A}$

$I_{TRMS} = 25 \text{ A}$  with  $I_{TSM} = 250 \text{ A}$

#### - Voltage rating :

$V_{DRM} = 600 \text{ V}$  provides a good safety margin for 220 VAC mains.

#### - Package :

Insulated cases are generally used to make easier mounting on chassis and thus reduce the cost.

TO220AB and TOP3 cases are suitable for printed board assembly. If the triac is mounted close of transformer (far from electronics board) RD92 with "FAST ON" connections is a convenient solution.

#### - Protection devices :

A bidirectional silicon diode suppressor (TRANSIL) with a peak power capability of 1500 W (1 ms) is a good compromise if there is a filter (coil + capacitor) at the line input. In fact it is necessary to have a

current limitation (series inductance) in case of overvoltage.

The breakdown voltage compatible with 220 VAC supply is  $V_{BR} = 440$  V.

– Part numbers :

triac

BTA12-600B/BW(1) 12 Amp TO220 AB

BTA16-600B/BW(1) 16 Amp TO220 AB

BTA26-600B/BW(1) 25 Amp TOP 3

BTA25-600B 25 Amp RD 91

TRANSIL 1.5KE440CP

**Figure 7 :** Triacs in insulated cases (UL approved)

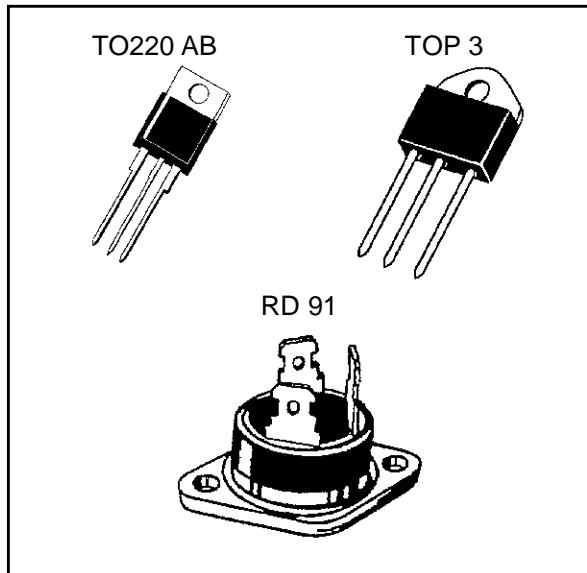

**II . HEATING RESISTOR CONTROL :**

1/ Triggering :

In this application the triac is used as a ON/OFF switch to control the power in the grill heater.

It is the case of resistive load. Therefore it is absolutely necessary to trigger the triac at zero voltage in order to eliminate the turn on di/dt stresses and RFI problems.

To keep the triac on, a single gate pulse can be supplied at every zero crossing of voltage that is also the zero point of current in this case.

The pulse duration must be calculated in order to allow the load current to reach the latching current ( $I_L$ ) of the triac.

(1) BW : SNUBBERLESS TRIAC series with high switching performance and high dv/dt capability.

**Figure 8 :** Controlled by the gate pulse,  $I_G$ , the triac is fired, and a current  $I_T$  flows through it. If the gate current  $I_G$  is stopped before current  $I_T$  reaches the value of the latching current  $I_L$ , the triac turns off.

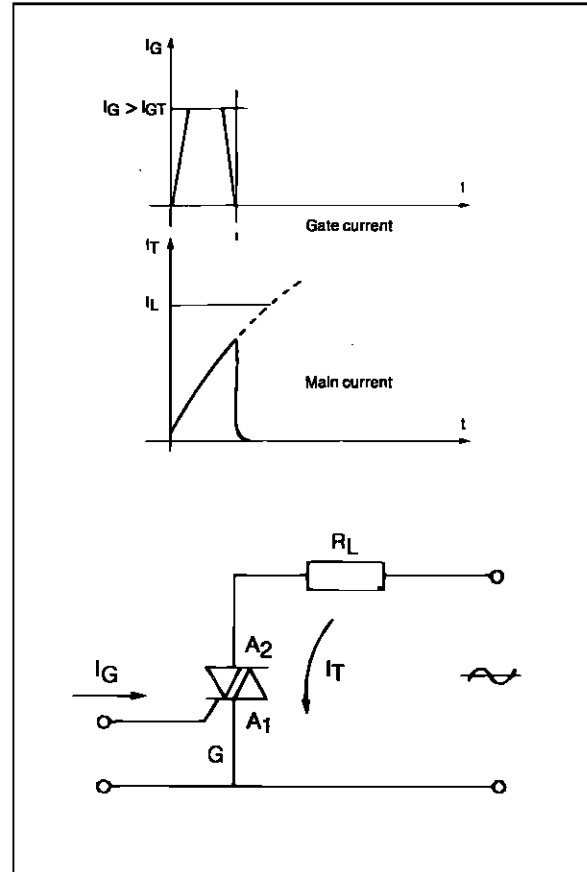

For triacs with max gate triggering current of 50 mA the latching current is lower than 120 mA.

2/ Current rating :

For normal operation there is no particular current stresses efficient cooling is required to minimize the thermal fatigue due to the variation of junction temperature and consequently increase the life time of the equipment.

3/ Protection :

With the new generation of triacs, SNUBBERLESS triacs, the commutation (turn-off) is possible without external limitation of (dv/dt)<sub>c</sub>, that is to say without RC network even

## APPLICATION NOTE

if the load is inductive.

In case of overvoltages the triac could be fired by exceeding its breakover voltage and generally it is destroyed because of the too high  $di/dt$ , that is limited only by the inductance of the load (very low for a heating resistor) and of the wiring.

A RC network across the triac cannot reduce the spikes because there is not enough inductance in series in the kind of circuit.

→RC snubber circuit is useless !

### HOW TO PROTECT ?

The solution consists in turning on the triac by a gate current as soon as the voltage across it exceeds a certain value which ensures a high level of safety.

To do it we use a low power (i-e low cost) bidirectional TRANSIL diode according to the diagram. Fig.8

When the overvoltage reaches the breakdown voltage  $V_{BR}$  of the TRANSIL the latter conducts and the current flows through the gate and turns the triac on. Fig.7

**Figure 9 :** Protection by TRANSIL the triac is turned on by the gate at the beginning of the overvoltage and continues conducting during the rest of the half cycle.

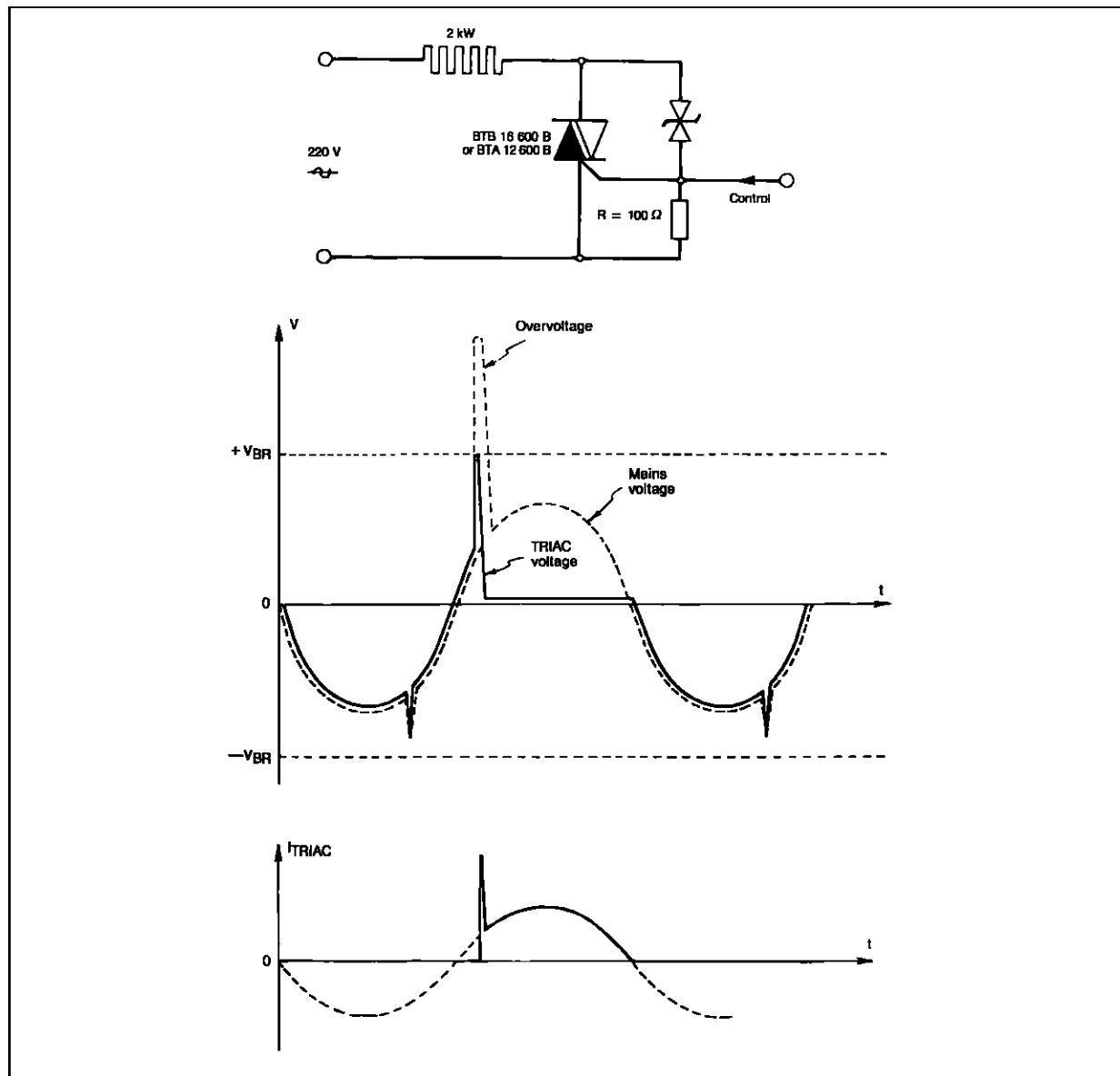

What part number ?

to protect a 600 V triac generally used for 220 VAC operation we recommend :  
 BZW04376B or BT.  
 for a 400 V triac (110 VAC mains) we propose a BZW04188B.

**III . TO SUMMARIZE :**

Transformer control :

Select triac with high surge current capability and with high transient immunity (SNUBBERLESS series).

Triggering :  
 first switching on, firing at peak line voltage to

reduce peak inrush current, then triggering with pulse train synchronized at zero current point.

Protection :  
 TRANSIL and RC network across the triac to avoid all risk of firing by overvoltage and/or dv/dt.

Heating resistor control :

Triggering at zero voltage absolutely necessary.  
 Protection :

\* with SNUBBERLESS triac, RC snubber circuit is useless.

\* TRANSIL diode connected between gate and A2 achieves an efficient protection against overvoltages.

**ANNEX**

TRANSFORMER CONTROL BY TRIAC

Triggering at voltage peak ---> peak current = 22 A

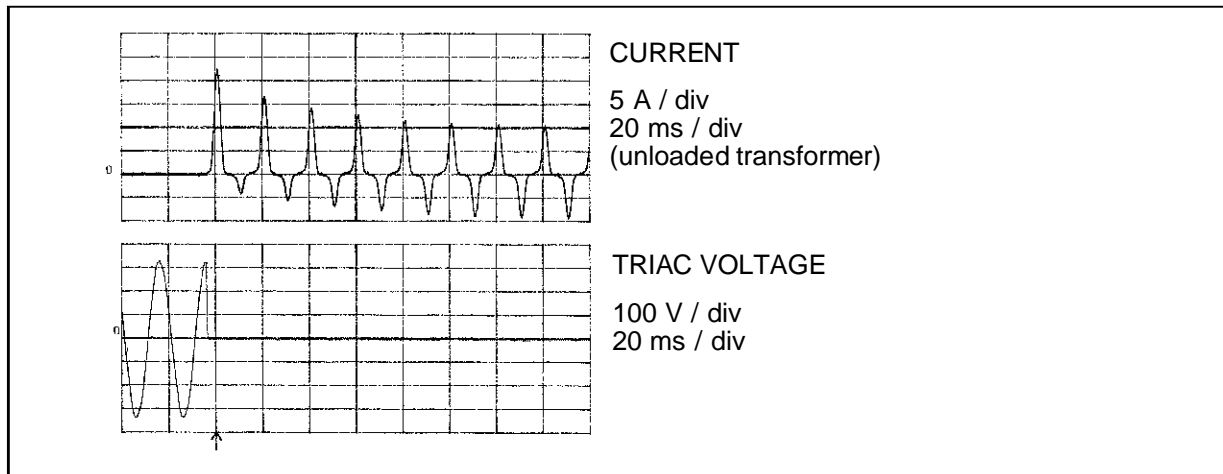

## APPLICATION NOTE

Triggering at zero voltage ---> peak current reaches 130 A !

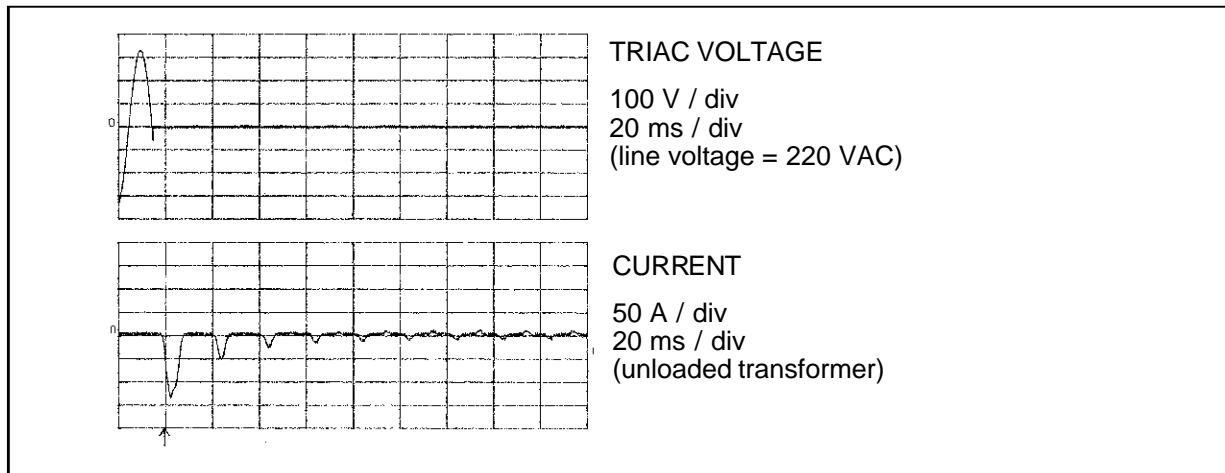

Steady state (without load)

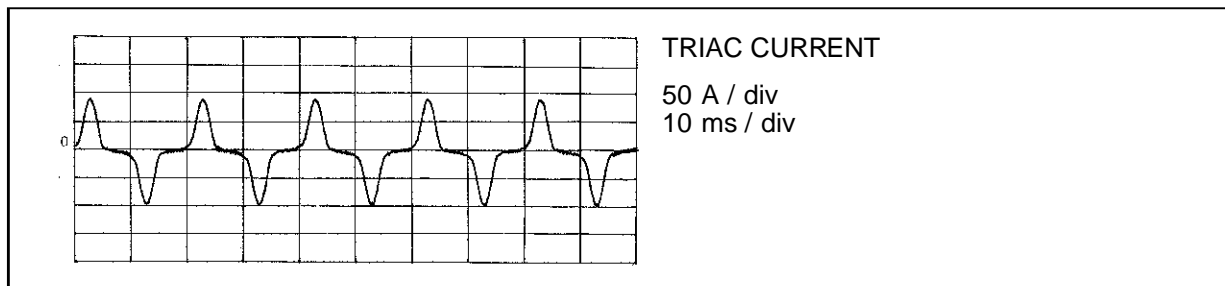

Information furnished is believed to be accurate and reliable. However, SGS-THOMSON Microelectronics assumes no responsibility for the consequences of use of such information nor for any infringement of patents or other rights of third parties which may result from its use. No license is granted by implication or otherwise under any patent or patent rights of SGS-THOMSON Microelectronics. Specifications mentioned in this publication are subject to change without notice. This publication supersedes and replaces all information previously supplied.

SGS-THOMSON Microelectronics products are not authorized for use as critical components in life support devices or systems without express written approval of SGS-THOMSON Microelectronics.

© 1995 SGS-THOMSON Microelectronics - Printed in Italy - All rights reserved.

SGS-THOMSON Microelectronics GROUP OF COMPANIES

Australia - Brazil - France - Germany - Hong Kong - Italy - Japan - Korea - Malaysia - Malta - Morocco -  
The Netherlands - Singapore - Spain - Sweden - Switzerland - Taiwan - Thailand - United Kingdom - U.S.A.