

ITEM	Q'TY	PART NUMBER	PART DESCRIPTION
1	1	FLPV2-XX	Flexible Light Pipe 2mm Adapter, Vertical w/ LED, See page 2
2	1	FLP25-XX.X	Flexible Light Pipe Lens Cap Assembly, 2mm

REV.	DESCRIPTION	DATE	APPROVED
A	Engineering Release	09/14/09	T. Y.

NOTE: FLPV2-XX ADAPTER SHIPPED NON-ASSEMBLED

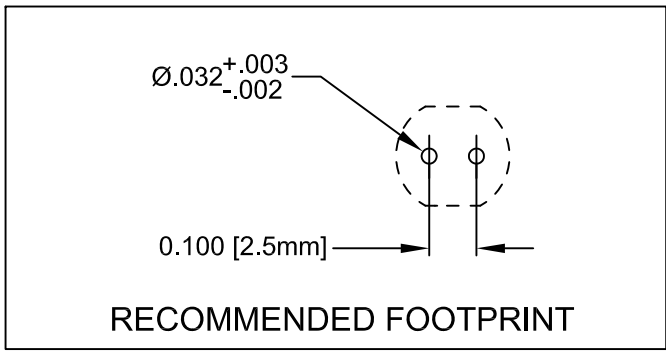
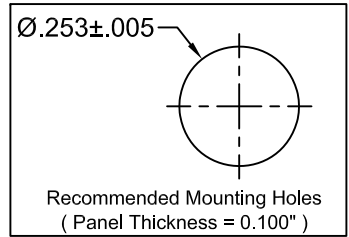
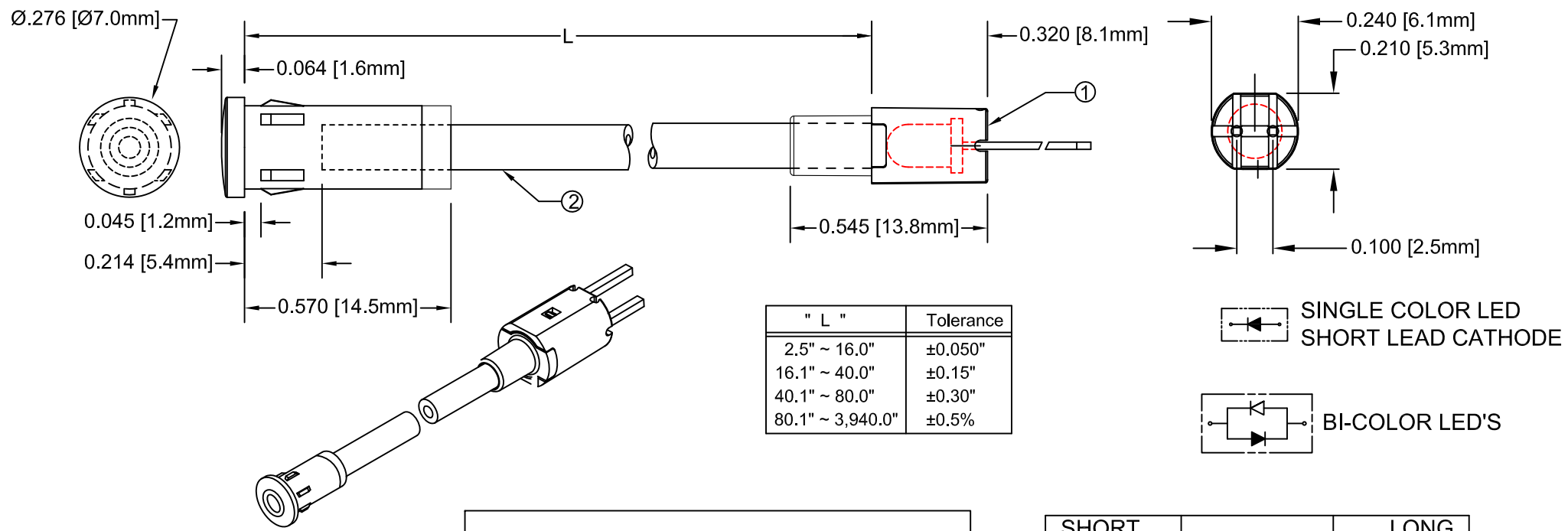

SHORT LEAD CATHODE	LED PART NO.	LONG LEAD CATHODE
RED	3xBCC-F	GREEN
YELLOW	3xBCC-Y/G-F	GREEN
RED	3xBCC-R/Y-F	YELLOW
AMBER	3xBCC-A/G-F	GREEN

ABSOLUTE MAXIMUM RATINGS (Ta=25°C)

REVERSE VOLTAGE _____	5V
REVERSE CURRENT _____	100uA
OPERATING TEMPERATURE RANGE _____	-25° C - 85° C
STORAGE TEMPERATURE _____	-30° C - 100° C
LEAD SOLDERING TEMPERATURE(1/16" FROM BODY) _____	260° C FOR 5 SECONDS

STANDARD TOLERANCE (UNLESS OTHERWISE SPECIFIED)		 BIVAR [®] 4 THOMAS, IRVINE, CA. 92618 TEL: (949) 951-8808 FAX: (949) 951-3974
DECIMALS	ANGULAR	
.X ±.1	X° ± 1°	
.XX ±.02		TITLE: FLEXIBLE LIGHT PIPE ASSY, 7mm ROUND, VERTICAL
.XXX ±.010		
DESIGNED: Brian Oliver	DATE: 09/14/09	PART NO: FLP25VX.X-XX
CHECKED: Fred Jensen	DATE: 09/14/09	
		CAGE CODE : 32559 SHEET # 1 OF 2 REVISION: A
CAD GENERATED DOCUMENT, DO NOT MEASURE DRAWING.		

REV.	DESCRIPTION	DATE	APPROVED
	SEE SHEET#1		

SINGLE COLOR ASSEMBLIES



BI-COLOR ASSEMBLIES

Assembly Part No.	Emitted Color	LED Part No.
FLP25VX.X-SA	AMBER	3SAC-F
FLP25VX.X-UBW	BLUE	3UBWC-0.6K-F
FLP25VX.X-SG	GREEN	3SGC-F
FLP25VX.X-UG	GREEN	3UGC-F
FLP25VX.X-SUG	GREEN	3SUGC-F
FLP25VX.X-UO	ORANGE	3UOC-F
FLP25VX.X-SUO	ORANGE	3SUOC-F
FLP25VX.X-SR	RED	3SRC-F
FLP25VX.X-UR	RED	3URC-F
FLP25VX.X-SUR	RED	3SURC-F
FLP25VX.X-UT	TURQUOISE	3UTC-F
FLP25VX.X-SY	YELLOW	3SYC-F
FLP25VX.X-UY	YELLOW	3UYC-F
FLP25VX.X-SUY	YELLOW	3SUYC-F
FLP25VX.X-UUY	YELLOW	3UUYC-F
FLP25VX.X-UW	WHITE	3UWC-0.6K-F

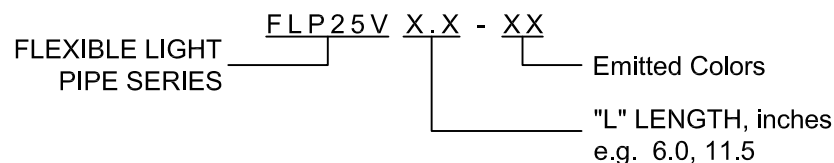
Assembly Part No.	Emitted Color	LED Part No.
FLP25VX.X-BC	HE RED	3BCC-F
	GREEN	
FLP25VX.X-YG	YELLOW	3BCC-Y/G-F
	GREEN	
FLP25VX.X-RY	YELLOW	3BCC-R/Y-F
	HE RED	
FLP25VX.X-AG	AMBER	3BCC-A/G-F
	GREEN	
FLP25VX.X-SBC	SUPER RED	3SBCC-F
	HE GREEN	
FLP25VX.X-SYG	SUPER YELLOW	3SBCC-Y/G-F
	HE GREEN	
FLP25VX.X-SRY	SUPER RED	3SBCC-R/Y-F
	SUPER YELLOW	



NOTES:
1. REFERENCE LED PRINTS FOR OPTICAL/ELECTRICAL SPECIFICATIONS

STANDARD TOLERANCE (UNLESS OTHERWISE SPECIFIED) DECIMALS ANGULAR		 BIVAR [®] 4 THOMAS, IRVINE, CA. 92618 TEL: (949) 951-8808 FAX: (949) 951-3974	
 			
DESIGNED: Brian Oliver	DATE: 09/14/09	PART NO: FLP25VX.X-XX	REVISION: A
CHECKED: Fred Jensen	DATE: 09/14/09	CAGE CODE : 32559	SHEET # 2 OF 2
CAD GENERATED DOCUMENT, DO NOT MEASURE DRAWING.			