

INNOLUX DISPLAY CORPORATION

LCD MODULE

SPECIFICATION

www.datasheet4u.com



Customer: _____
Model Name: AT070TN83 V.1
SPEC NO.: A070-83-TT-11
Date: 2007/05/11
Version: 01

- Preliminary Specification
 Final Specification

Option
<input checked="" type="checkbox"/> AT070TN83 V.1 LCM (TTL T-con with LED Driver)

For Customer's Acceptance

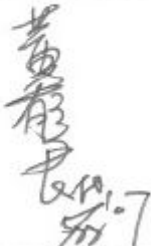
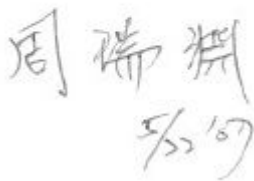
Approved by	Comment

Approved by	Reviewed by	Prepared by
		

版權屬於群創所有，禁止任何未經授權的使用

The copyright belongs to InnoLux. Any unauthorized use is prohibited.

The copyright belongs to INNOLUX. Any unauthorized use is prohibited. www.DataSheet4U.com

Record of Revision

www.datasheet4u.com

Version	Revise Date	Page	Content
Pre. Spec. 01	2006/12/05		Initial release.
02	2007/03/05	2	Add Note 1,2,3 Modify TTL connector model from "FH19S-40S-0.5SH" to "FH19SC-40S-0.5SH"
		3	Add Note 4 Add " I: input, O: output, P: power"
		6	Add "Backlight Driving Conditions"
		16	Add Note 4
		18	Modify TTL connector model in the Mechanical Drawing
Final-spec.01	2007/05/11	1	Modify backlight power consumption from "1.728W" to "2.500W". Modify panel power consumption from "0.990W" to "0.825W".
		5	Add the Max.value of V_{LED} .
		6	Modify the Typ.value of I_{cc} from "300mA" to "250mA" and Max.value from "350mA" to "300mA". Modify " I_L " to " I_{LED} " and the value from "180mA" to "500mA". Add Max.value of I_{LED} . Add Note 2,Note 3. Modify Note 5.
		12	Modify test condition 1.
		14	Modify Note 6.
		19	Add the weight of corrugated board.

Contents

www.datasheet4u.com

1. General Specifications	1
2. Pin Assignment	2
3. Operation Specifications	5
3.1. Absolute Maximum Ratings	5
3.2. Typical Operation Conditions	6
3.3. Power Sequence	7
3.4. Timing Characteristics	8
3.4.1. Timing Conditions	8
3.4.2. Timing Diagram	10
4. Optical Specifications	12
5. Reliability Test Items	16
6. General Precautions	17
6.1. Safety	17
6.2. Handling	17
6.3. Static Electricity	17
6.4. Storage	17
6.5. Cleaning	17
7. Mechanical Drawing	18
8. Package Drawing	19
8.1. Packaging Material Table	19
8.2. Packaging Quantity	19
8.3. Packaging Drawing	20

1. General Specifications

No.	Item	Specification	Remark
1	LCD size	7.0 inch(Diagonal)	
2	Driver element	a-Si TFT active matrix	
3	Resolution	800X3(RGB)X480	
4	Display mode	Normally white, Transmissive	
5	Dot pitch	0.0635(W)X0.1905(H) mm	
6	Active area	152.4 (W)X91.44 (H) mm	
7	Module size	165(W)X104(H)X5.5(D) mm	Note 1
8	Surface treatment	Anti-Glare	
9	Color arrangement	RGB-stripe	
10	Interface	Digital(TTL)	
11	Backlight power consumption	2.500W(Typ.)	Note 3
12	Panel power consumption	0.825W(Typ.)	Note 2
13	Weight	130g (Typ.)	

Note 1: Refer to Mechanical Drawing.

Note 2: Including T-con Board power consumption.

Note 3: Including LED Driver power consumption.

2. Pin Assignment

TFT LCD Panel Driving Section

www.datasheet4u.com

TTL Connector is used for the module electronics interface. The recommended model is FH19SC-40S-0.5SH manufactured by Hirose.

Pin No.	Symbol	I/O	Function	Remark
1	V _{LED}	P	Power voltage for LED Driver	
2	V _{LED}	P	Power voltage for LED Driver	
3	ADJ	I	Adjust the led brightness with PWM Pulse	Note 1,2
4	G _{LED}	P	Ground for LED circuit	
5	G _{LED}	P	Ground for LED circuit	
6	V _{CC}	P	Power voltage for digital circuit	
7	V _{CC}	P	Power voltage for digital circuit	
8	MODE	I	DE or HV mode control	Note 3
9	DE	I	Data enable	
10	VS	I	Vsync signal input	
11	HS	I	Hsync signal input	
12	GND	P	Power ground	
13	B5	I	Blue data input (MSB)	
14	B4	I	Blue data input	
15	B3	I	Blue data input	
16	GND	P	Power ground	
17	B2	I	Blue data input	
18	B1	I	Blue data input	

版權屬於群創所有，禁止任何未經授權的使用

19	B0	I	Blue data input(LSB)	
20	GND	P	Power ground	
21	G5	I	Green data input(MSB)	
22	G4	I	Green data input	
23	G3	I	Green data input	
24	GND	P	Power ground	
25	G2	I	Green data input	
26	G1	I	Green data input	
27	G0	I	Green data input(LSB)	
28	GND	P	Power ground	
29	R5	I	Red data input(MSB)	
30	R4	I	Red data input	
31	R3	I	Red data input	
32	GND	P	Power ground	
33	R2	I	Red data input	
34	R1	I	Red data input	
35	R0	I	Red data input(LSB)	
36	GND	P	Power ground	
37	DCLK	I	Sample clock	
38	GND	P	Power ground	
39	L/R	I	Select left or right scanning direction	Note 4
40	U/D	I	Select up or down scanning direction	Note 4

I: input, O: output, P: power

Note1: ADJ adjust brightness to control Pin,Pulse duty the bigger the brighter.

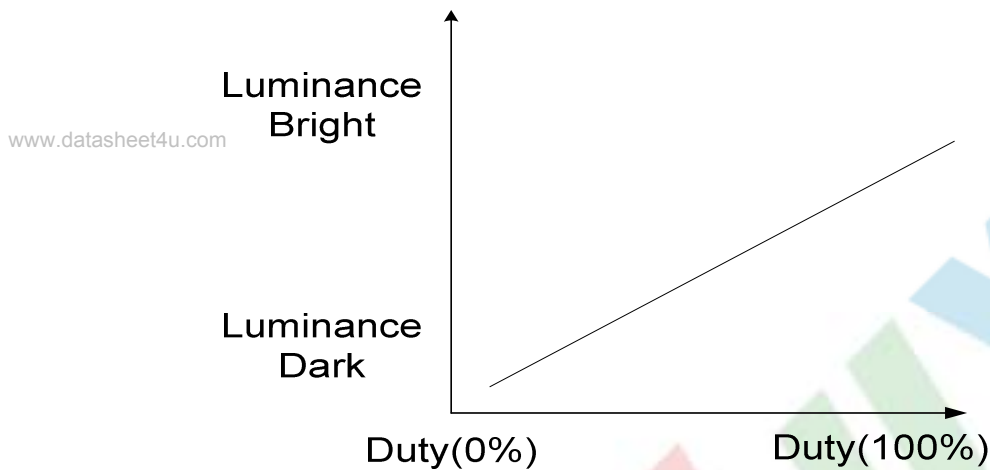

Note 2: ADJ signal=0~3.3V;Operating frequency:100~300Hz.

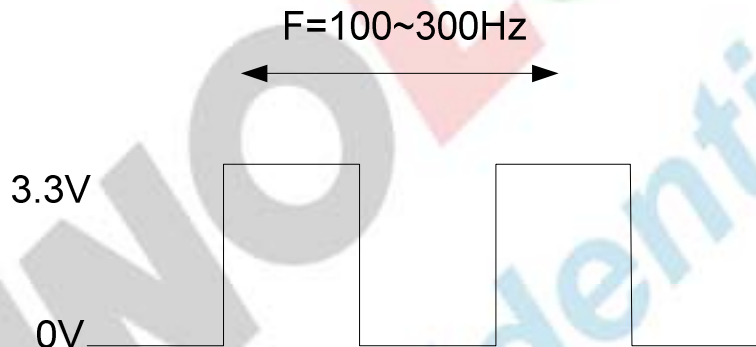

Note 3: DE Mode: Mode="H", HS floating and VS floating.
HV Mode: Mode="L" and DE floating.

Note 4: Selection of scanning mode

Setting of scan control input		Scanning direction
U/D	L/R	
GND	V _{CC}	Up to down, left to right
V _{CC}	GND	Down to up, right to left
GND	GND	Up to down, right to left
V _{CC}	V _{CC}	Down to up, left to right

3. Operation Specifications

3.1. Absolute Maximum Ratings

www.datasheet4u.com

Item	Symbol	Values		Unit	Remark
		Min.	Max.		
Power voltage	V_{CC}	-0.3	6.0	V	
	V_{LED}	-	5.5	V	
Input signal voltage	V_I	-0.3	6.3	V	
Operation Temperature	T_{OP}	-20	70	°C	
Storage Temperature	T_{ST}	-30	80	°C	

Note: The absolute maximum rating values of this product are not allowed to be exceeded at any times. A module should be used with any of the absolute maximum ratings exceeded, the characteristics of the module may not be recovered, or in an extreme condition, the module may be permanently destroyed.

3.2. Typical Operation Conditions

Item	Symbol	Values			Unit	Remark
		Min.	Typ.	Max.		
Power voltage	V _{CC}	3.1	3.3	3.5	V	Note 1
	V _{LED}	4.8	5.0	5.2	V	Note 2
Current consumption	I _{CC}	-	250	300	mA	
	I _{LED}	-	500	550	mA	Note 3
Input logic high voltage	V _{IH}	0.7V _{CC}	-	V _{CC}	V	Note 4
Input logic low voltage	V _{IL}	0	-	0.3V _{CC}	V	
LED life time	-	20,000	-	-	Hr	Note 5

Note 1: V_{CC} setting should match the signals output voltage (refer to Note 4) of customer's system board.

Note 2: LED driving voltage.

Note 3: LED driving current.

Note 4: DCLK, DE, HS, VS, R0~ R5, G0~ G5, B0~ B5.

Note 5: The "LED life time" is defined as the module brightness decrease to 50% original brightness at Ta=25°C and V_{LED}=5.0V. The LED lifetime could be decreased if operating V_{LED} is larger than 5.0V.

3.3. Power Sequence

www.datasheet4u.com

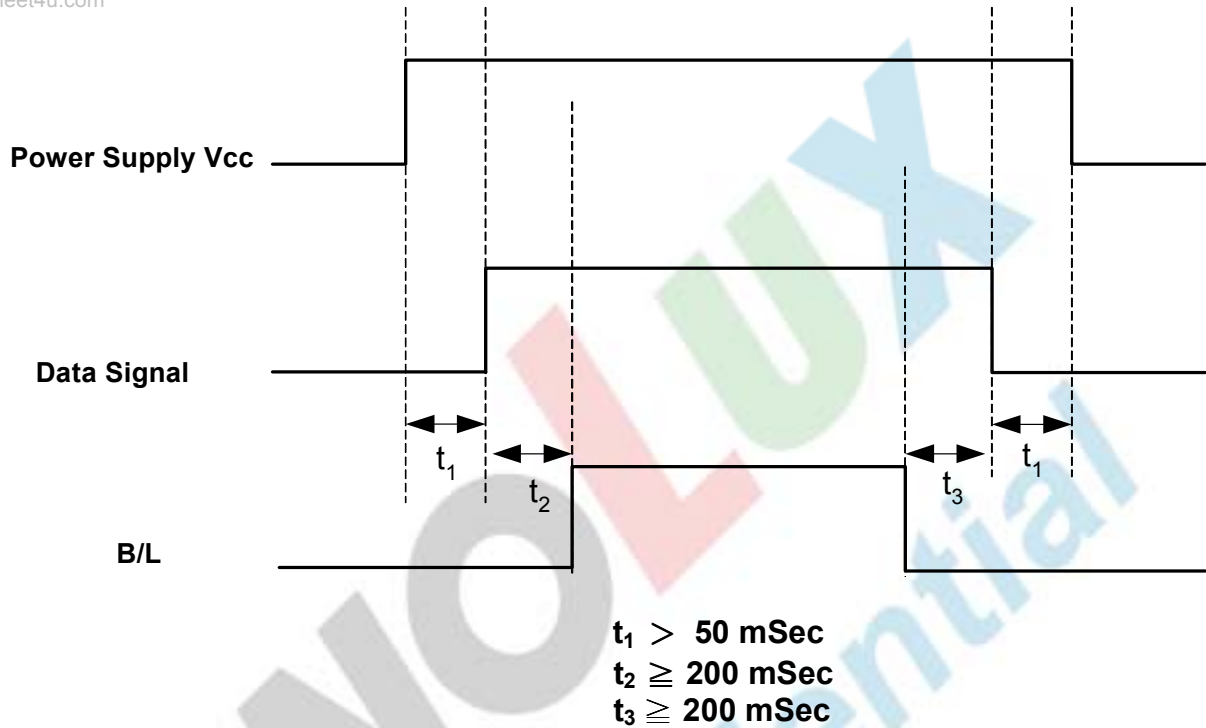

Note: Data Signal includes DCLK, DE, HS, VS, R0~ R5, G0~ G5, B0~ B5.

3.4. Timing Characteristics

3.4.1. Timing Conditions

www.datasheet4u.com SYNC mode Input signal characteristics (800 x 480)

Item	Symbol	Values			Unit	Remark
		Min.	Typ.	Max.		
Clock Period	t _{CLK}	20.0	30.0	-	ns	
Clock Frequency	f _{CLK}	-	33.3	50	MHz	
Clock Low Level Width	t _{WCL}	8	-	-	ns	
Clock High Level Width	t _{WCH}	8	-	-		
Clock Rise/Fall Time	t _{CLKr} , t _{CLKf}	-	-	3		
HSYNC Period	t _{HP}	-	928	-	t _{CLK}	
HSYNC Pulse Width	t _{HW}	-	48	-	t _{CLK}	
HSYNC Back Porch	t _{HBP}	-	40	-	t _{CLK}	
HSYNC Width + Back Porch	t _{hw} + t _{HBP}	88			t _{CLK}	
Horizontal valid data width	t _{HV}	800			t _{CLK}	
HSYNC Front Porch	t _{HFP}	t _{HP} - t _{HW} - t _{HBP} - t _{HV}			t _{CLK}	
Horizontal Blank	t _{HBK}	t _{HP} - t _{HV}			t _{CLK}	
VSYNC Period	t _{VP}	-	525	-	t _{HP}	
VSYNC Pulse Width	t _{VW}	-	3	-	t _{HP}	
VSYNC Back Porch	t _{VBP}	29			t _{HP}	
Vertical valid data width	t _v	480			t _{HP}	
Vertical Front Porch	t _{VFP}	t _{VP} - t _{VW} - t _{VBP} - t _v			t _{HP}	
Vertical Blank	t _{VBK}	t _{VP} - t _v			t _{HP}	
Data Setup Time	t _{DS}	5	-	-	ns	
Data Hold Time	t _{DH}	10	-	-	ns	

版權屬於研創所有，禁止任何未經授權的使用

DE mode Input signal characteristics (800 x 480)

Item	Symbol	Values			Unit	Remark
		Min.	Typ.	Max.		
DCLK	Period	t _{CLK}	20.0	30.0	-	ns
	Frequency	f _{CLK}	-	33.3	50	MHz
	Low Level Width	t _{WCL}	6	-	-	ns
	High Level Width	t _{WCH}	6	-	-	
	Rise/Fall Time	t _{CLKr} , t _{CLKf}	-	-	3	
	Duty	-	0.45	0.50	0.55	-
DE	Setup Time	t _{DES}	5	-	-	ns
	Hold Time	t _{DEH}	10	-	-	
	Rise/Fall Time	t _{DEr} , t _{DEf}	-	-	16	
	Horizontal Period	t _{HP}	-	928	-	t _{CLK}
	Horizontal Valid	t _{HV}	800			
	Horizontal Blank	t _{HBK}	t _{HP} - t _{HV}			
	Vertical Period	t _{VP}	-	525	-	t _{HP}
	Vertical Valid	t _w	480			
	Vertical Blank	t _{VBK}	t _{VP} - t _w			
DATA	Setup Time	t _{DS}	5	-	-	ns
	Hold Time	t _{DH}	10	-	-	
	Rise/Fall Time	t _{Dr} , t _{Df}	-	-	3	

3.4.2. Timing Diagram

www.datasheet4u.com

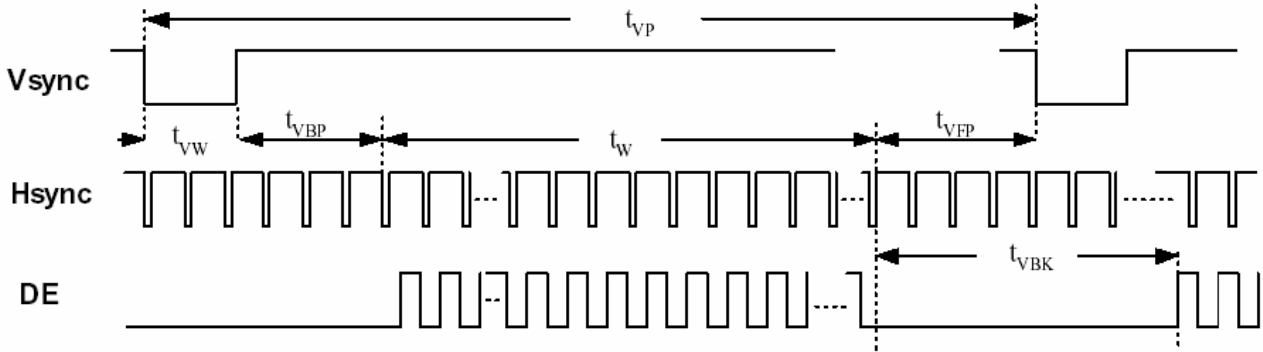

Input Vertical Timing

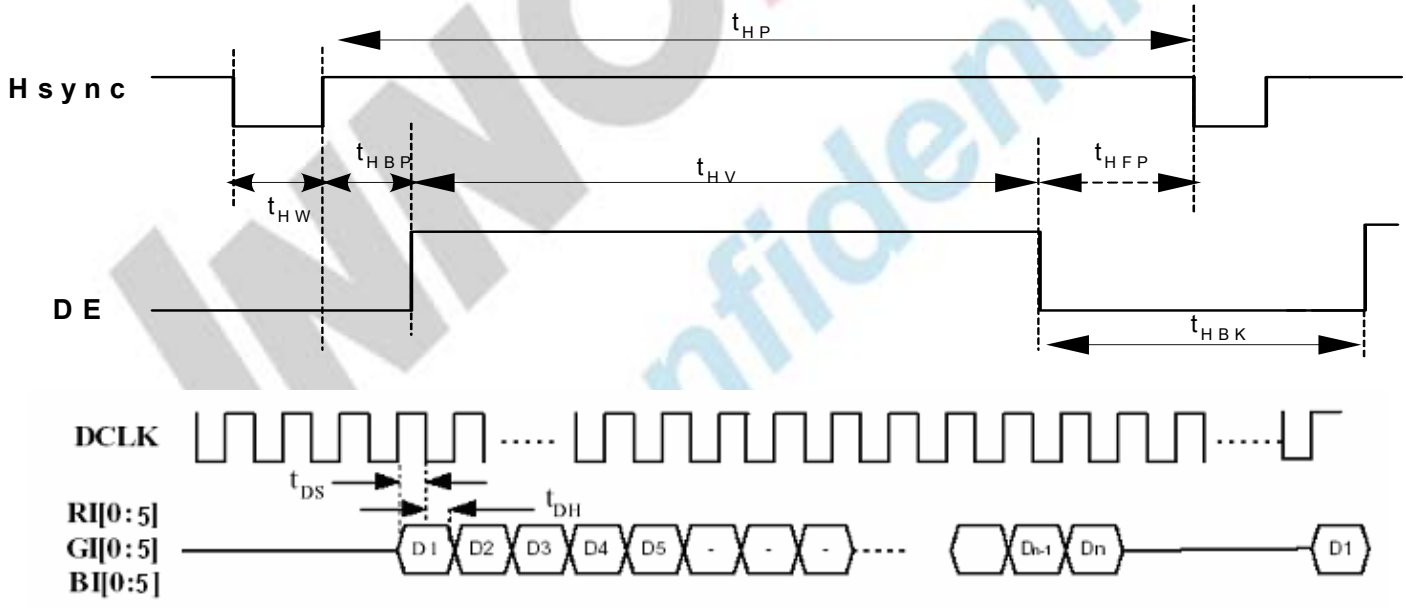

Input Horizontal Timing

版權屬於群創所有，禁止任何未經授權的使用

The copyright belongs to InnoLux. Any unauthorized use is prohibited.

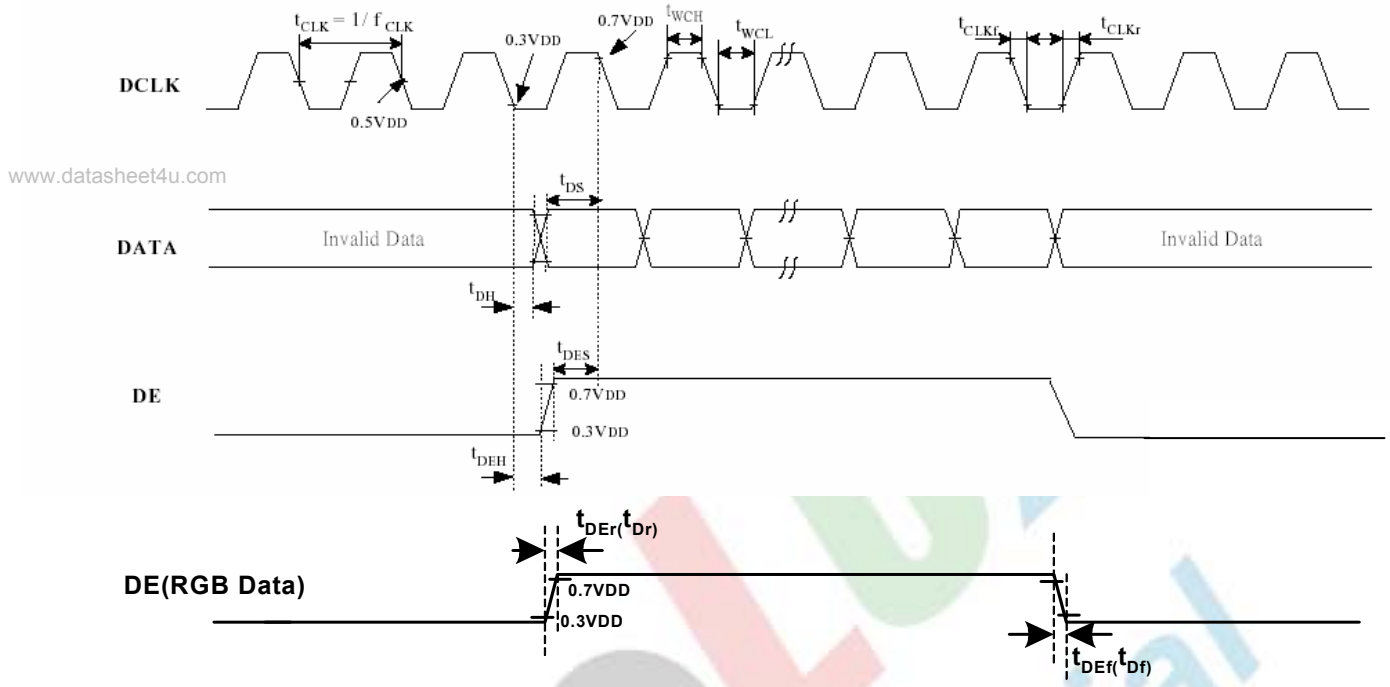

DE and RGB Input Timing

4. Optical Specifications

Item	Symbol	Condition	Values			Unit	Remark
			Min.	Typ.	Max.		
Viewing angle (CR≥ 10)	θ_L	$\Phi=180^\circ$ (9 o'clock)	60	70	-	degree	Note 1
	θ_R	$\Phi=0^\circ$ (3 o'clock)	60	70	-		
	θ_T	$\Phi=90^\circ$ (12 o'clock)	40	50	-		
	θ_B	$\Phi=270^\circ$ (6 o'clock)	60	70	-		
Response time	T_{ON}	Normal $\theta=\Phi=0^\circ$	-	10	20	msec	Note 3
	T_{OFF}		-	15	30	msec	Note 3
Contrast ratio	CR		400	500	-	-	Note 4
Color chromaticity	W_X		0.26	0.31	0.36	-	Note 2 Note 5
	W_Y		0.28	0.33	0.38	-	Note 6
Luminance	L		250	300	-	Cd/m ²	Note 6
Luminance uniformity	Y_U		70	75	-	%	Note 7

Test Conditions:

1. $V_{CC}=3.3V$, $V_{LED}=5.0V$.The ambient temperature is 25°C.
2. The test systems refer to Note 2.

Note 1: Definition of viewing angle

www.datasheet4u.com

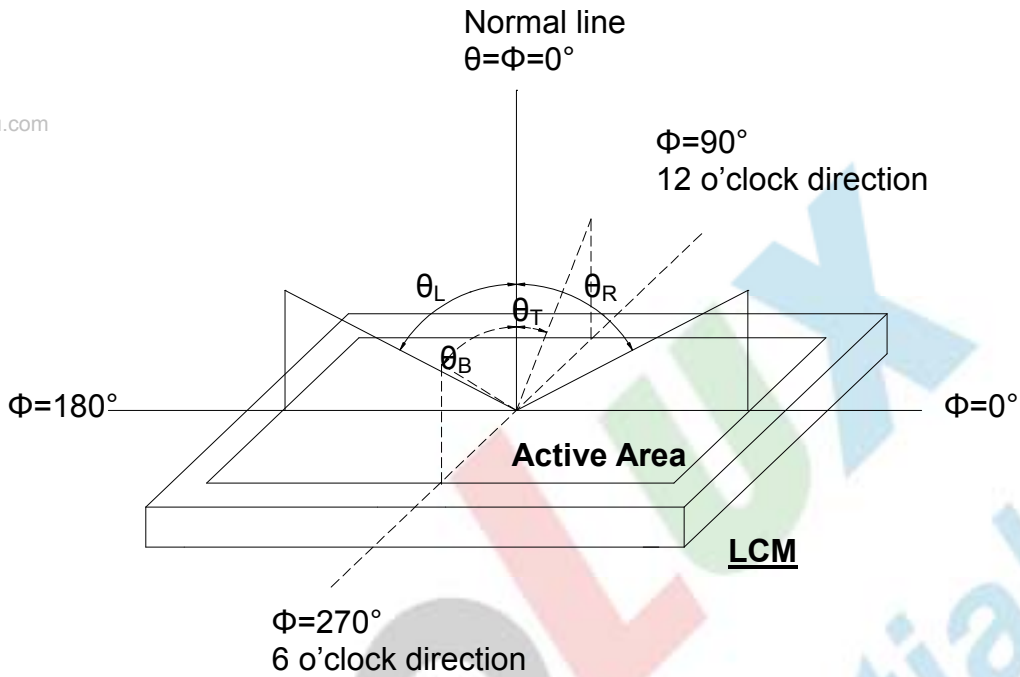

Fig. 4-1 Definition of viewing angle

Note 2: Definition of optical measurement system.

The optical characteristics should be measured in dark room. After 30 minutes operation, the optical properties are measured at the center point of the LCD screen. (Response time is measured by Photo detector TOPCON BM-7, other items are measured by BM-5A/Field of view: 1° /Height: 500mm.)

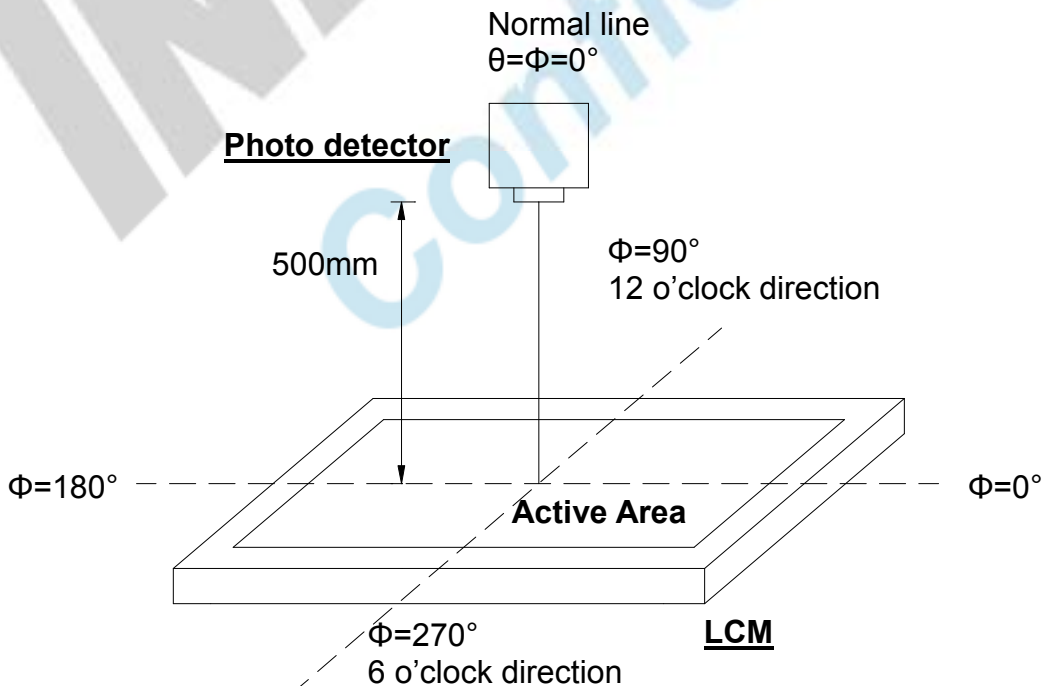

Fig. 4-2 Optical measurement system setup

版權屬於群創所有，禁止任何未經授權的使用

Note 3: Definition of Response time

The response time is defined as the LCD optical switching time interval between "White" state and "Black" state. Rise time (T_{ON}) is the time between photo detector output intensity changed from 90% to 10%. And fall time (T_{OFF}) is the time between photo detector output intensity changed from 10% to 90%.

www.datasheet4u.com

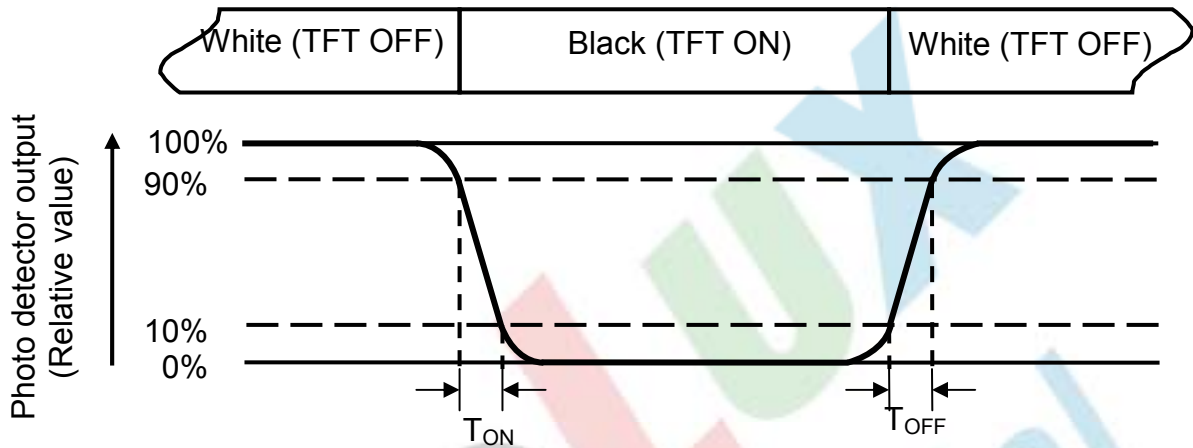

Fig. 4-3 Definition of response time

Note 4: Definition of contrast ratio

$$\text{Contrast ratio (CR)} = \frac{\text{Luminance measured when LCD on the "White" state}}{\text{Luminance measured when LCD on the "Black" state}}$$

Note 5: Definition of color chromaticity (CIE1931)

Color coordinates measured at center point of LCD.

Note 6: All input terminals LCD panel must be ground while measuring the center area of the panel. The LED driving condition is $V_{LED}=5.0V$.

Note 7: Definition of Luminance Uniformity

Active area is divided into 9 measuring areas (Refer to Fig. 4-4).Every measuring point is placed at the center of each measuring area.

$$\text{Luminance Uniformity (Yu)} = \frac{B_{min}}{B_{max}}$$

www.datasheet4u.com

L-----Active area length W----- Active area width

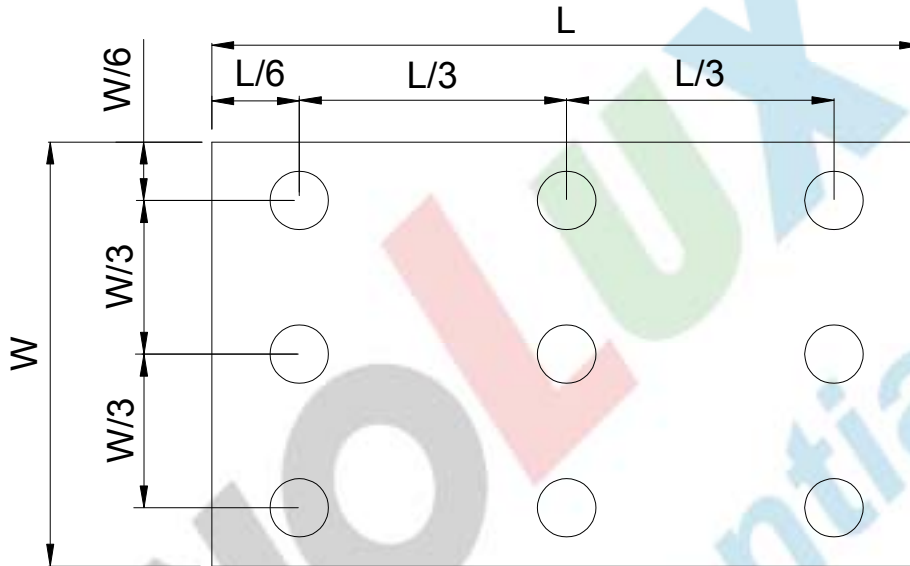

Fig. 4-4 Definition of measuring points

B_{max}: The measured maximum luminance of all measurement position.

B_{min}: The measured minimum luminance of all measurement position.

6. General Precautions

6.1. Safety

www.datasheet4u.com

Liquid crystal is poisonous. Do not put it in your mouth. If liquid crystal touches your skin or clothes, wash it off immediately by using soap and water.

6.2. Handling

1. The LCD panel is plate glass. Do not subject the panel to mechanical shock or to excessive force on its surface.
2. The polarizer attached to the display is easily damaged. Please handle it carefully to avoid scratch or other damages.
3. To avoid contamination on the display surface, do not touch the module surface with bare hands.
4. Keep a space so that the LCD panels do not touch other components.
5. Put cover board such as acrylic board on the surface of LCD panel to protect panel from damages.
6. Transparent electrodes may be disconnected if you use the LCD panel under environmental conditions where the condensation of dew occurs.
7. Do not leave module in direct sunlight to avoid malfunction of the ICs.

6.3. Static Electricity

1. Be sure to ground module before turning on power or operating module.
2. Do not apply voltage which exceeds the absolute maximum rating value.

6.4. Storage

1. Store the module in a dark room where must keep at $25\pm 10^{\circ}\text{C}$ and 65%RH or less.
2. Do not store the module in surroundings containing organic solvent or corrosive gas.
3. Store the module in an anti-electrostatic container or bag.

6.5. Cleaning

1. Do not wipe the polarizer with dry cloth. It might cause scratch.
2. Only use a soft sloth with IPA to wipe the polarizer, other chemicals might permanent damage to the polarizer.

7. Mechanical Drawing

www.datasheet4u.com

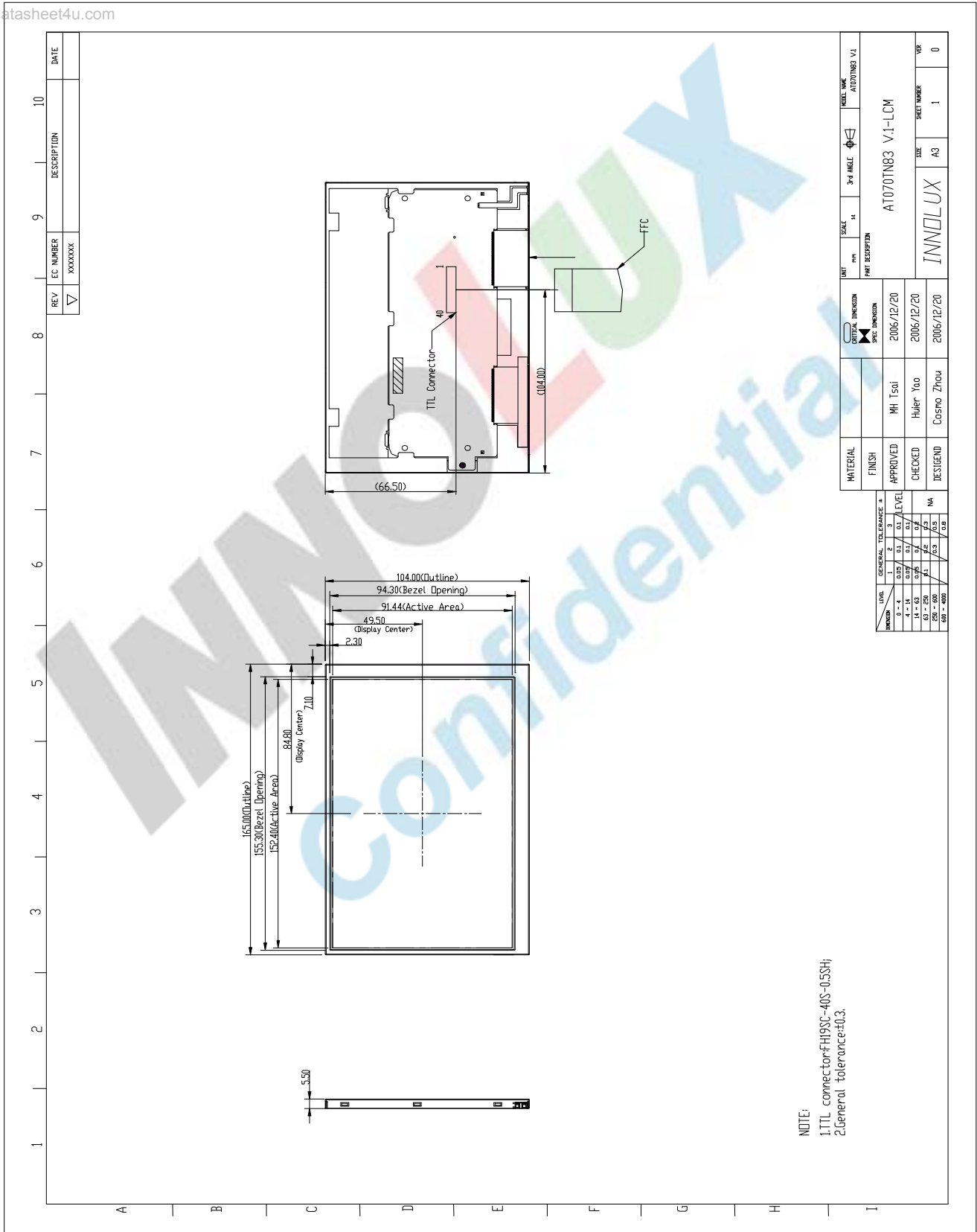

NOTE:
 1. TTL connector: HI93C-40S-0.5SH;
 2. General tolerance: ±0.3.

版權屬於群創所有，禁止任何未經授權的使用

8. Package Drawing

8.1. Packaging Material Table

www.datasheet4u.com

No.	Item	Model (Material)	Dimensions(mm)	Unit Weight (kg)	Quantity	Remark	
1	LCM Module	AT070TN83 V.1	165X104X5.5	0.130	50pcs		
2	Partition	BC Corrugated Paper	512 X 349 X 226	1.466	1 set		
3	Corrugated Bar	BC Corrugated Paper	512X162	0.046	4 set		
4	Corrugated Board	BC Corrugated Paper	510 X 343	0.130	1pcs		
5	Dust-Proof Bag	PE	700X530	0.048	1 pcs		
6	A/S Bag	PE	180 X 160 X 0.05	0.002	50 pcs		
7	Carton	Corrugated paper	530 X 355 X 255	1.100	1 pcs		
8	Total weight	9.528 Kg ± 5%					

8.2. Packaging Quantity

Total LCM quantity in Carton: no. of Partition	2 Rows x	quantity per Row	25	= 50
--	----------	------------------	----	------

8.3. Packaging Drawing

www.datasheet4u.com

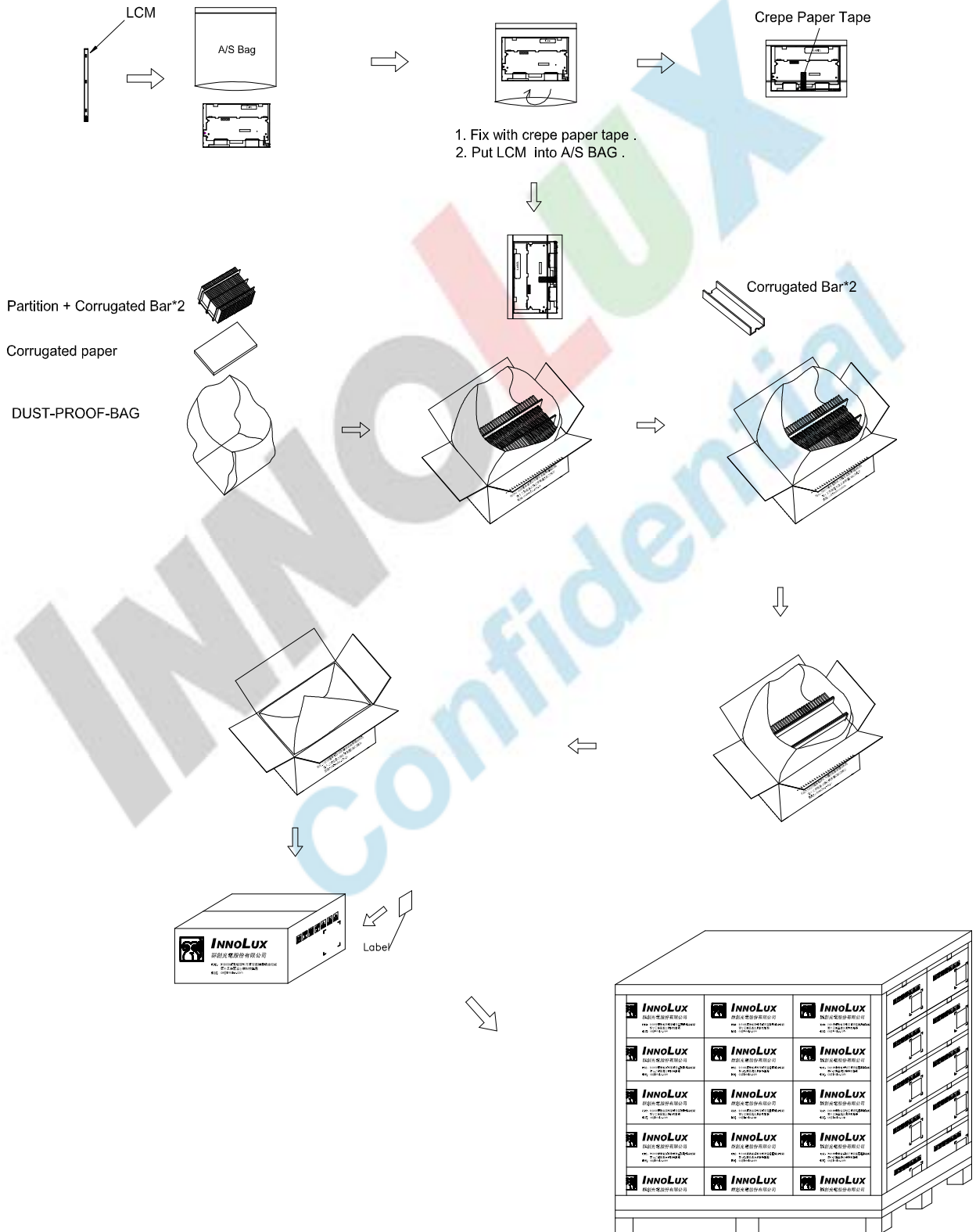

版權屬於群創所有，禁止任何未經授權的使用

The copyright belongs to Innolux. Any unauthorized use is prohibited.