



RF Power Field Effect Transistors

N-Channel Enhancement-Mode Lateral MOSFETs

RF Power transistors designed for applications operating at frequencies between 2700 and 2900 MHz. These devices are suitable for use in pulsed applications.

- Typical Pulsed Performance: $V_{DD} = 30$ Volts, $I_{DQ} = 100$ mA

Signal Type	P_{out} (W)	f (MHz)	G_{ps} (dB)	η_D (%)	IRL (dB)
Pulsed (100 μ sec, 10% Duty Cycle)	320 Peak	2900	13.3	50.5	-17

- Capable of Handling 10:1 VSWR, @ 32 Vdc, 2900 MHz, 320 Watts Peak Power, 300 μ sec, 10% Duty Cycle (3 dB Input Overdrive from Rated P_{out})

Features

- Characterized with Series Equivalent Large-Signal Impedance Parameters
- Internally Matched for Ease of Use
- Qualified Up to a Maximum of 32 V_{DD} Operation
- Integrated ESD Protection
- Designed for Push-Pull Operation
- Greater Negative Gate-Source Voltage Range for Improved Class C Operation
- RoHS Compliant
- In Tape and Reel. R6 Suffix = 150 Units, 56 mm Tape Width, 13 inch Reel. For R5 Tape and Reel option, see p. 15.

MRF8P29300HR6
MRF8P29300HSR6

2700-2900 MHz, 320 W, 30 V
LATERAL N-CHANNEL
BROADBAND
RF POWER MOSFETs

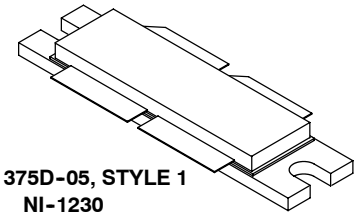

CASE 375D-05, STYLE 1
NI-1230
MRF8P29300HR6

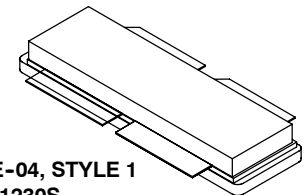

CASE 375E-04, STYLE 1
NI-1230S
MRF8P29300HSR6

PARTS ARE PUSH-PULL

Table 1. Maximum Ratings

Rating	Symbol	Value	Unit
Drain-Source Voltage	V_{DSS}	-0.5, +65	Vdc
Gate-Source Voltage	V_{GS}	-6.0, +10	Vdc
Storage Temperature Range	T_{stg}	-65 to +150	$^{\circ}$ C
Case Operating Temperature	T_C	150	$^{\circ}$ C
Operating Junction Temperature (1,2)	T_J	225	$^{\circ}$ C

Table 2. Thermal Characteristics

Characteristic	Symbol	Value (2,3)	Unit
Thermal Resistance, Junction to Case	$Z_{\theta JC}$		$^{\circ}$ C/W
Case Temperature 61 $^{\circ}$ C, 320 W Pulsed, 300 μ sec Pulse Width, 10% Duty Cycle, 100 mA, 2900 MHz		0.06	
Case Temperature 69 $^{\circ}$ C, 320 W Pulsed, 500 μ sec Pulse Width, 20% Duty Cycle, 100 mA, 2900 MHz		0.10	

- Continuous use at maximum temperature will affect MTTF.
- MTTF calculator available at <http://www.freescale.com/rf>. Select Software & Tools/Development Tools/Calculators to access MTTF calculators by product.
- Refer to AN1955, *Thermal Measurement Methodology of RF Power Amplifiers*. Go to <http://www.freescale.com/rf>. Select Documentation/Application Notes - AN1955.

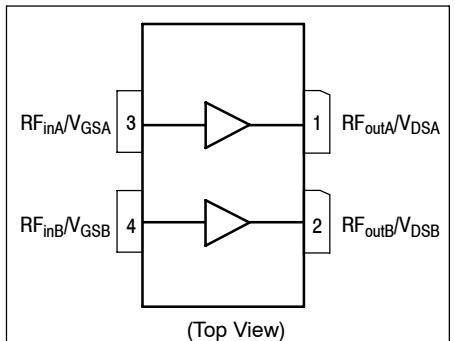

Figure 1. Pin Connections

Table 3. ESD Protection Characteristics

Test Methodology	Class
Human Body Model (per JESD22-A114)	2 (Minimum)
Machine Model (per EIA/JESD22-A115)	A (Minimum)
Charge Device Model (per JESD22-C101)	IV (Minimum)

Table 4. Electrical Characteristics ($T_A = 25^\circ\text{C}$ unless otherwise noted)

Characteristic	Symbol	Min	Typ	Max	Unit
Off Characteristics ⁽¹⁾					
Gate-Source Leakage Current ($V_{GS} = 5\text{ Vdc}$, $V_{DS} = 0\text{ Vdc}$)	I_{GSS}	—	—	1	μAdc
Zero Gate Voltage Drain Leakage Current ($V_{DS} = 30\text{ Vdc}$, $V_{GS} = 0\text{ Vdc}$)	I_{DSS}	—	—	1	μAdc
Zero Gate Voltage Drain Leakage Current ($V_{DS} = 65\text{ Vdc}$, $V_{GS} = 0\text{ Vdc}$)	I_{DSS}	—	—	10	μAdc

On Characteristics

Gate Threshold Voltage ⁽¹⁾ ($V_{DS} = 10\text{ Vdc}$, $I_D = 345\ \mu\text{Adc}$)	$V_{GS(th)}$	1.0	1.9	2.5	Vdc
Gate Quiescent Voltage ⁽²⁾ ($V_{DD} = 30\text{ Vdc}$, $I_D = 100\text{ mAdc}$, Measured in Functional Test)	$V_{GS(Q)}$	1.5	2.3	3.0	Vdc
Drain-Source On-Voltage ⁽¹⁾ ($V_{GS} = 10\text{ Vdc}$, $I_D = 2\text{ Adc}$)	$V_{DS(on)}$	0.1	0.18	0.3	Vdc

Dynamic Characteristics ⁽¹⁾

Reverse Transfer Capacitance ($V_{DS} = 30\text{ Vdc} \pm 30\text{ mV(rms)ac}$ @ 1 MHz, $V_{GS} = 0\text{ Vdc}$)	C_{rss}	—	2.53	—	pF
Output Capacitance ($V_{DS} = 30\text{ Vdc} \pm 30\text{ mV(rms)ac}$ @ 1 MHz, $V_{GS} = 0\text{ Vdc}$)	C_{oss}	—	470	—	pF
Input Capacitance ($V_{DS} = 30\text{ Vdc}$, $V_{GS} = 0\text{ Vdc} \pm 30\text{ mV(rms)ac}$ @ 1 MHz)	C_{iss}	—	264	—	pF

Functional Tests ⁽²⁾ (In Freescale Test Fixture, 50 ohm system) $V_{DD} = 30\text{ Vdc}$, $I_{DQ} = 100\text{ mA}$, $P_{out} = 320\text{ W Peak}$ (32 W Avg.), $f = 2900\text{ MHz}$, 100 μsec Pulse Width, 10% Duty Cycle

Power Gain	G_{ps}	12.0	13.3	15.0	dB
Drain Efficiency	η_D	47.0	50.5	—	%
Input Return Loss	IRL	—	-17	-9	dB

Typical Pulsed RF Performance (In Freescale 2"x3" Compact Test Fixture, 50 ohm system) $V_{DD} = 30\text{ Vdc}$, $I_{DQ} = 100\text{ mA}$, $P_{out} = 320\text{ W Peak}$ (32 W Avg.), 300 μsec Pulse Width, 10% Duty Cycle

Frequency	G_{ps} (dB)	η_D (%)	IRL (dB)
2700 MHz	13.9	49.3	-11
2800 MHz	14.0	49.8	-18
2900 MHz	13.0	49.6	-15

- Each side of device measured separately.
- Measurement made with device in push-pull configuration.

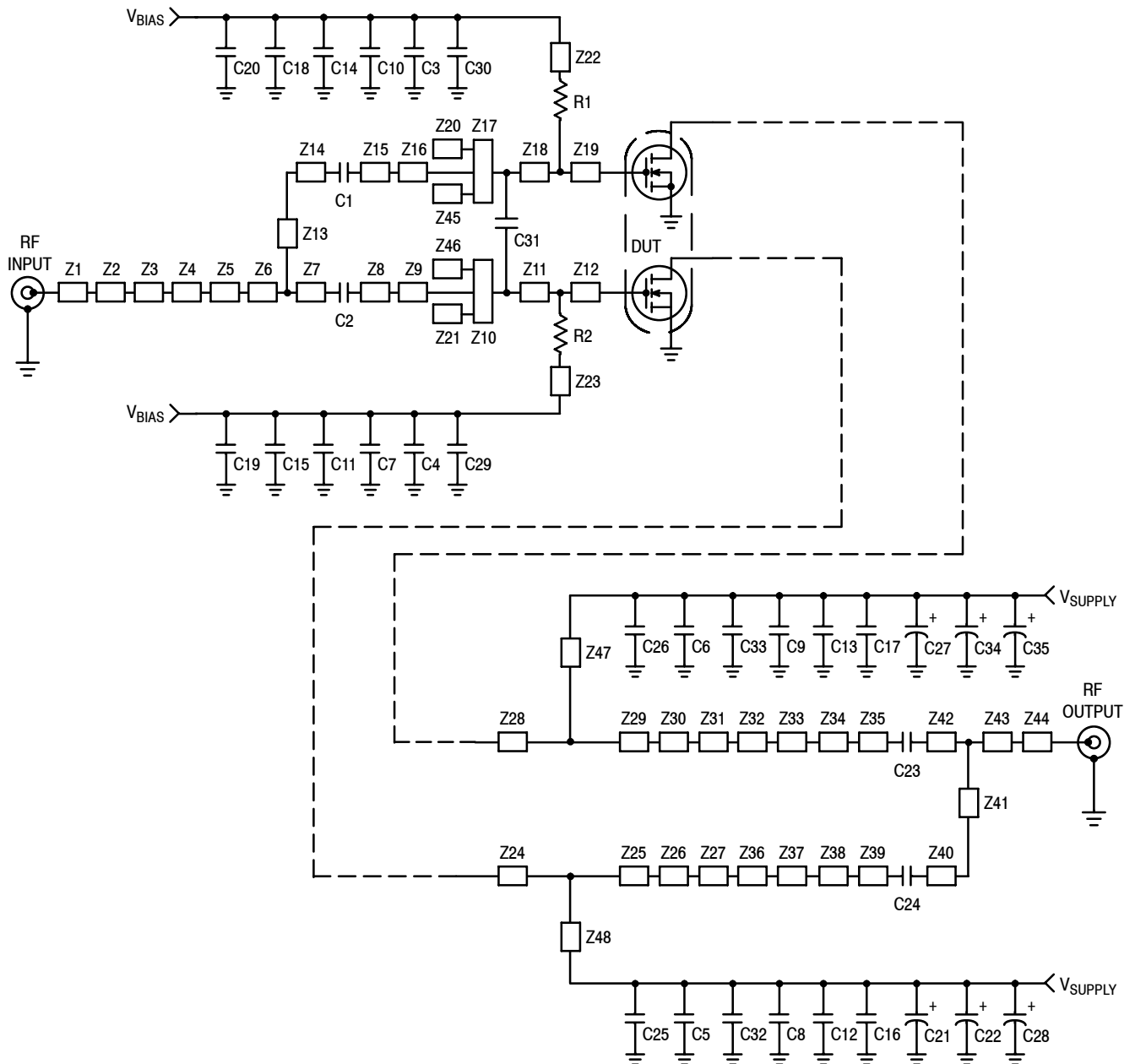

Z1*	0.865" x 0.065" Microstrip	Z11, Z18	0.135" x 0.620" Microstrip	Z33, Z37	0.112" x 0.232" Microstrip
Z2	0.100" x 0.110" Microstrip	Z12, Z19	0.120" x 0.620" Microstrip	Z34, Z38	0.158" x 0.152" Microstrip
Z3	0.075" x 0.065" Microstrip	Z13*	0.957" x 0.065" Microstrip	Z35, Z39	0.058" x 0.065" Microstrip
Z4	0.146" x 0.111" Microstrip	Z14	0.495" x 0.065" Microstrip	Z40	0.505" x 0.065" Microstrip
Z5	0.325" x 0.204" Microstrip	Z20, Z21, Z45, Z46	0.055" x 0.100" Microstrip	Z41*	0.917" x 0.065" Microstrip
Z6	0.224" x 0.111" Microstrip	Z22, Z23*	0.554" x 0.060" Microstrip	Z42*	0.092" x 0.065" Microstrip
Z7*	0.121" x 0.065" Microstrip	Z24, Z28	0.202" x 0.610" Microstrip	Z43	0.695" x 0.111" Microstrip
Z8, Z15	0.030" x 0.065" Microstrip	Z25, Z29	0.166" x 0.560" Microstrip	Z44*	0.479" x 0.065" Microstrip
Z9, Z16	0.284" x 0.165" Microstrip	Z26, Z30	0.200" x 0.622" Microstrip	Z47, Z48*	0.409" x 0.100" Microstrip
Z10, Z17	0.105" x 0.620" Microstrip	Z27, Z31	0.088" x 0.331" Microstrip		
		Z32, Z36	0.247" x 0.098" Microstrip		

* Line length includes microstrip bends

Figure 2. MRF8P29300HR6(HSR6) Test Circuit Schematic

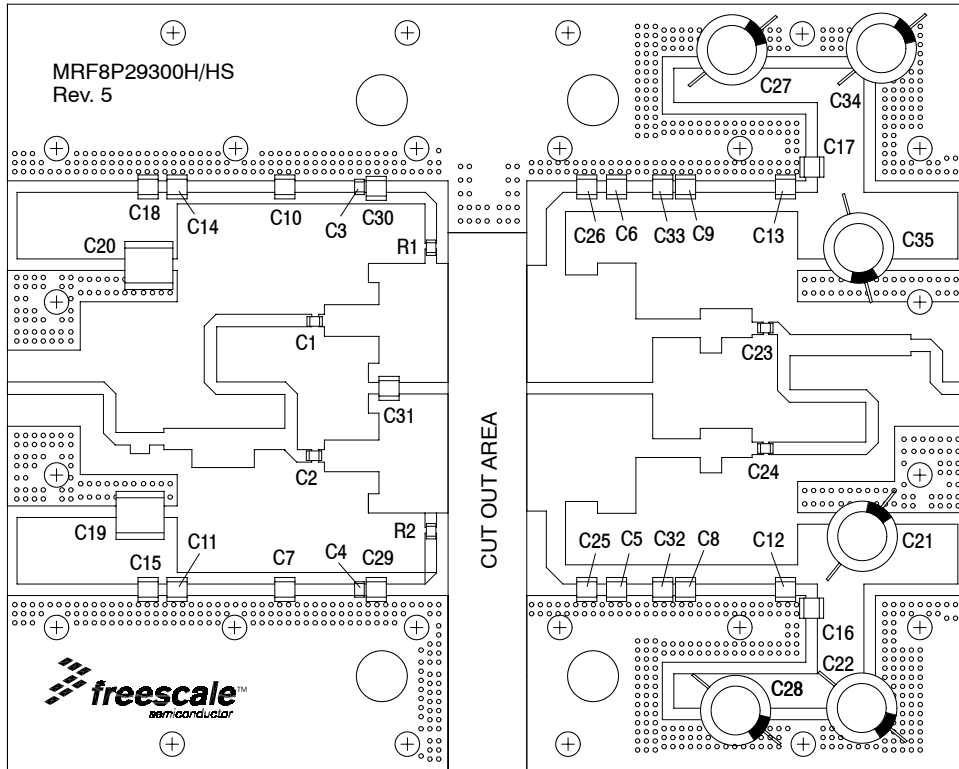
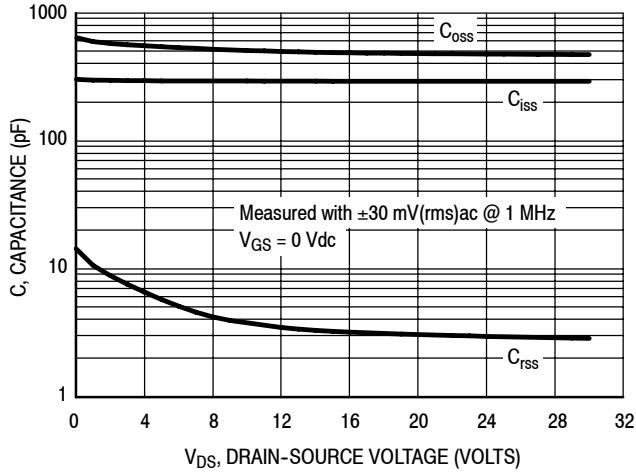

Figure 3. MRF8P29300HR6(HSR6) Test Circuit Component Layout

Table 5. MRF8P29300HR6(HSR6) Test Circuit Component Designations and Values

Part	Description	Part Number	Manufacturer
C1, C2	3.3 pF Chip Capacitors	ATC600F3R3BT250XT	ATC
C3, C4	18 pF Chip Capacitors	ATC600F180JT250XT	ATC
C5, C6, C25, C26, C29, C30	5.1 pF Chip Capacitors	ATC100B5R1BT250XT	ATC
C7, C8, C9, C10	100 pF Chip Capacitors	ATC100B101JT500XT	ATC
C11, C12, C13, C14	1000 pF Chip Capacitors	ATC100B102JT50XT	ATC
C15, C16, C17, C18	1 μ F Chip Capacitors	GRM32ER72A105KA01L	Murata
C19, C20	22 μ F Chip Capacitors	C5750KF1H226ZT	TDK
C21, C22, C27, C28, C34, C35	470 μ F, 63 V Electrolytic Capacitors	MCGPR63V477M16X32-RH	Multicomp
C23, C24	5.1 pF Chip Capacitors	ATC600F5R1CT500XT	ATC
C31	0.5 pF Chip Capacitor	ATC100B0R5BT500XT	ATC
C32, C33	1 μ F Chip Capacitors	C3225JB2A105KT	TDK
R1, R2	5 Ω Chip Resistors	CRCW08055R00JNEA	Vishay
PCB	0.030", $\epsilon_r = 3.5$	RF35A2	Taconic

TYPICAL CHARACTERISTICS



Note: Each side of device measured separately.

Figure 4. Capacitance versus Drain-Source Voltage

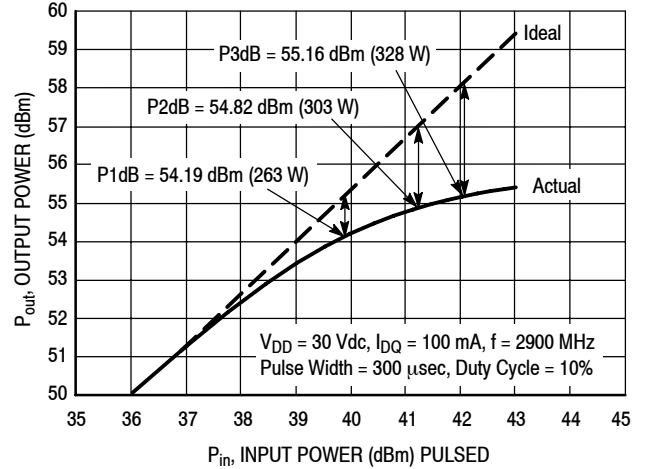

Figure 5. Pulsed Output Power versus Input Power

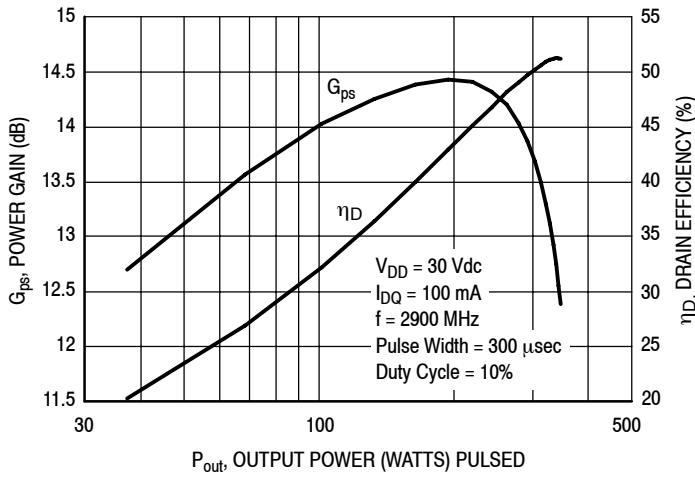

Figure 6. Pulsed Power Gain and Drain Efficiency versus Output Power

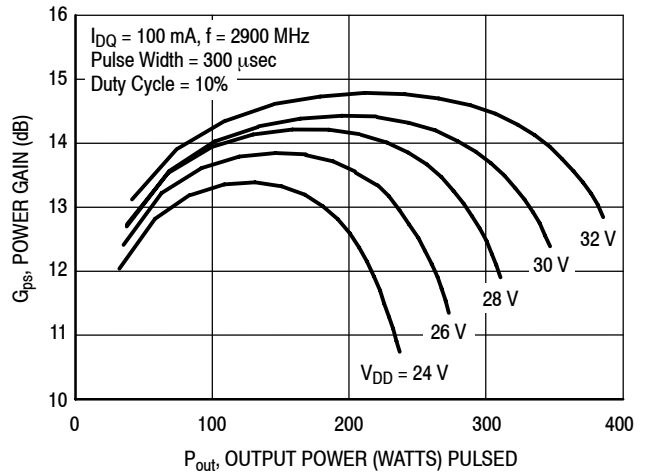

Figure 7. Pulsed Power Gain versus Output Power

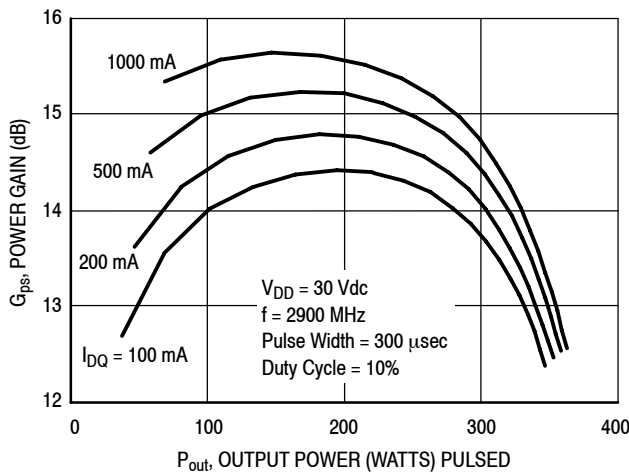

Figure 8. Pulsed Power Gain versus Output Power

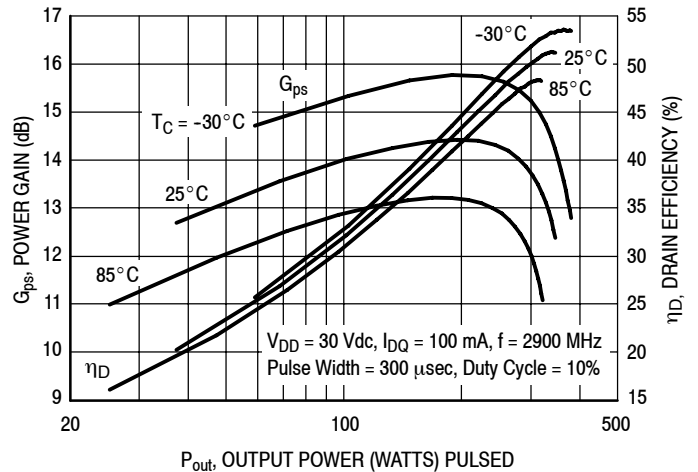

Figure 9. Pulsed Power Gain and Drain Efficiency versus Output Power

MRF8P29300HR6 MRF8P29300HSR6

TYPICAL CHARACTERISTICS

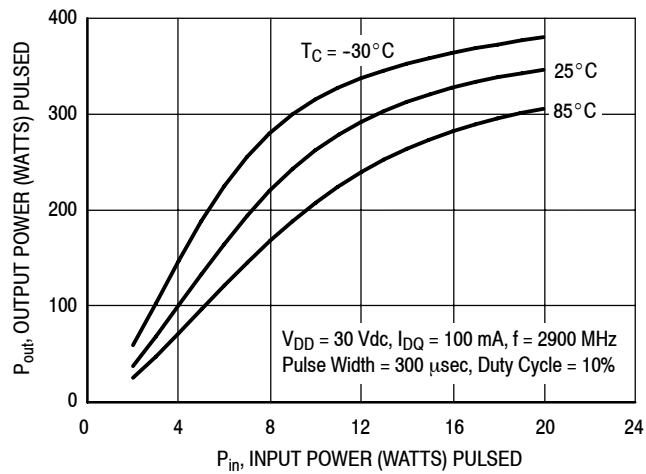

Figure 10. Pulsed Output Power versus Input Power

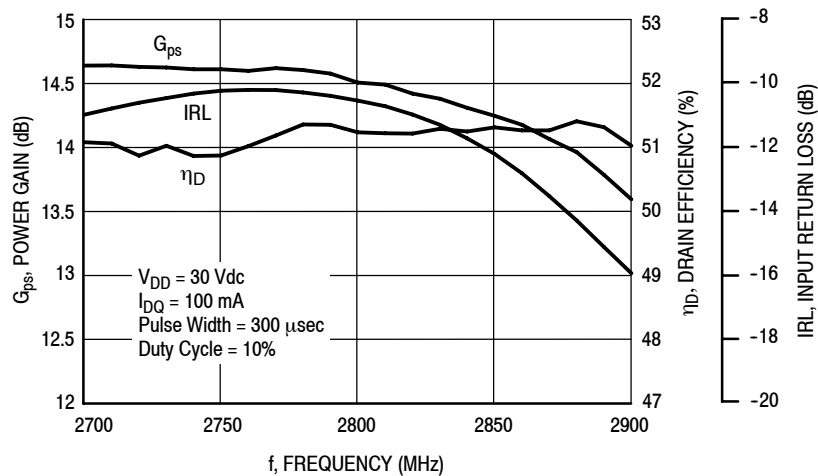
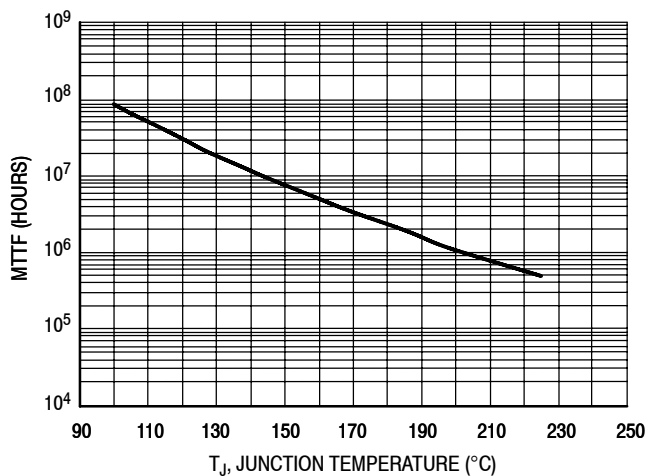

Figure 11. Pulsed Power Gain, Drain Efficiency and Input Return Loss versus Frequency

TYPICAL CHARACTERISTICS



This above graph displays calculated MTTF in hours when the device is operated at $V_{DD} = 30$ Vdc, $P_{out} = 320$ W Peak, Pulse Width = 300 μ sec, Duty Cycle = 10%, and $\eta_D = 45\%$.

MTTF calculator available at <http://www.freescale.com/rf>. Select Software & Tools/Development Tools/Calculators to access MTTF calculators by product.

Figure 12. MTTF versus Junction Temperature

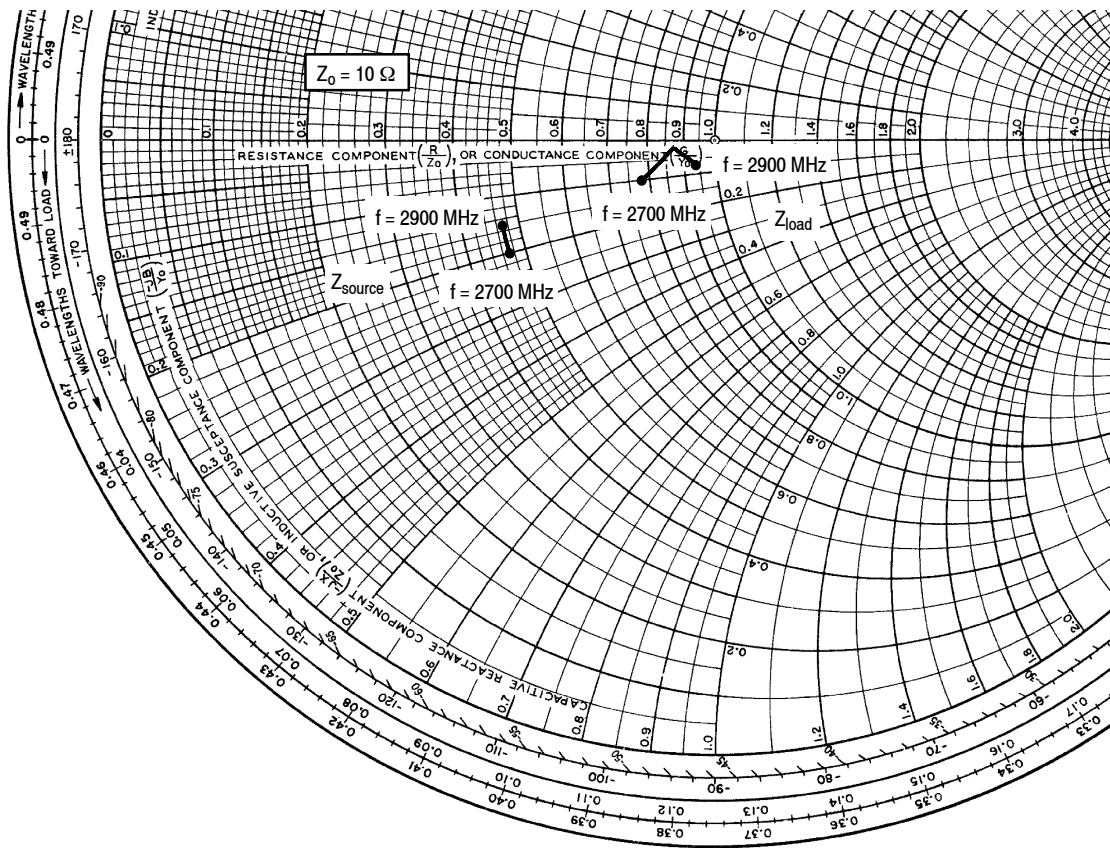

$V_{DD} = 30 \text{ Vdc}$, $I_{DQ} = 100 \text{ mA}$, $P_{out} = 320 \text{ W Peak}$

f MHz	Z_{source} Ω	Z_{load} Ω
2700	$4.7 - j2.0$	$7.8 - j1.0$
2800	$4.7 - j1.7$	$8.7 - j0.2$
2900	$4.7 - j1.5$	$9.4 - j0.7$

Z_{source} = Test circuit impedance as measured from gate to gate, balanced configuration.

Z_{load} = Test circuit impedance as measured from drain to drain, balanced configuration.

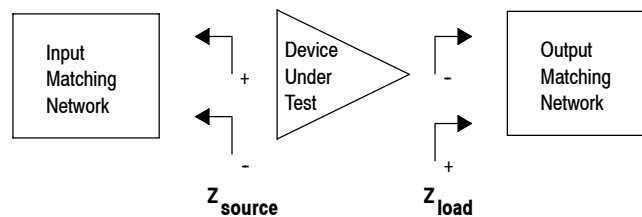

Figure 13. Series Equivalent Source and Load Impedance

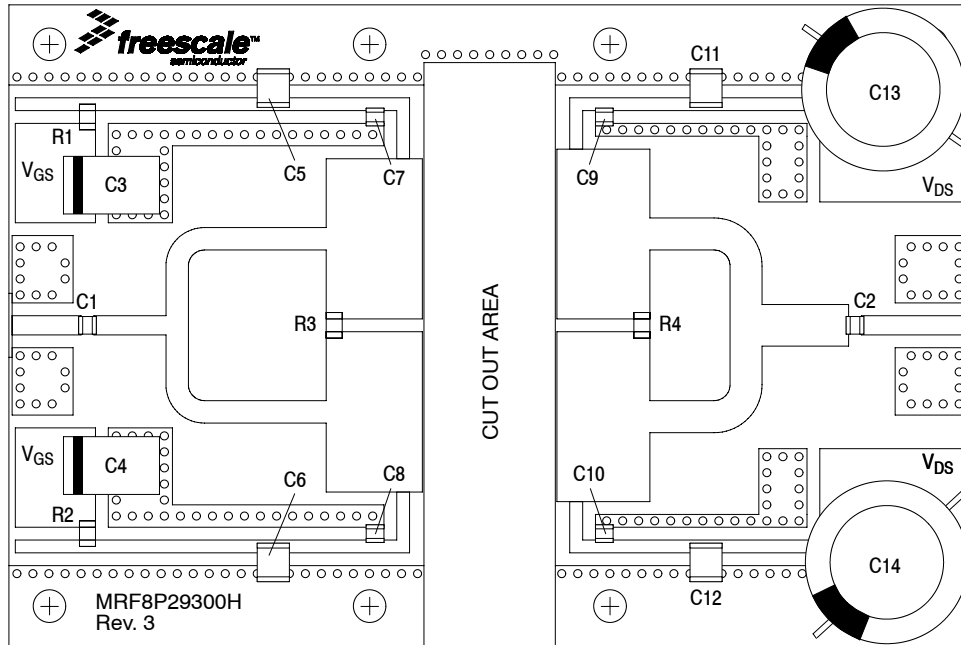

Figure 14. MRF8P29300HR6(HSR6) 2"x3" Compact Test Circuit Component Layout

Table 6. MRF8P29300HR6(HSR6) 2"x3" Compact Test Circuit Component Designations and Values

Part	Description	Part Number	Manufacturer
C1, C2	4.7 pF Chip Capacitors	ATC100A4R7BT150XT	ATC
C3, C4	47 μ F, 16 V Tantalum Capacitors	T491D476K016AT	Kemet
C5, C6, C11, C12	100 pF Chip Capacitors	ATC100B101JT500XT	ATC
C7, C8, C9, C10	15 pF Chip Capacitors	ATC100A150JT150XT	ATC
C13, C14	470 μ F, 63 V Electrolytic Capacitors	MCGPR63V477M13X26-RH	Multicomp
R1, R2, R3, R4	10 Ω Chip Resistors	CRCW120610R0JNEA	Vishay
PCB	0.050", $\epsilon_r = 10.2$	RO3010	Rogers

TYPICAL CHARACTERISTICS — 2"x3" COMPACT TEST FIXTURE

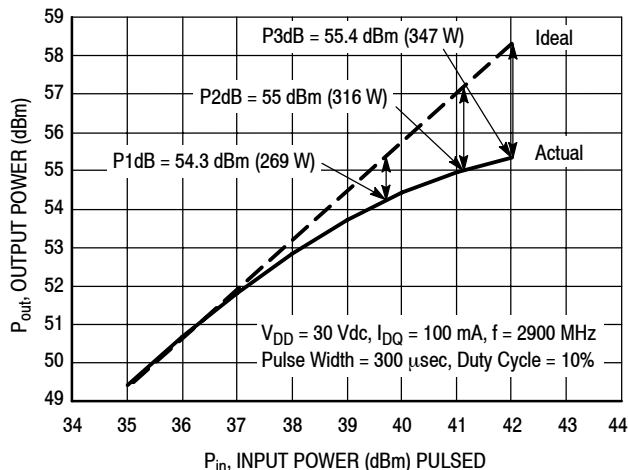

Figure 15. Pulsed Output Power versus Input Power

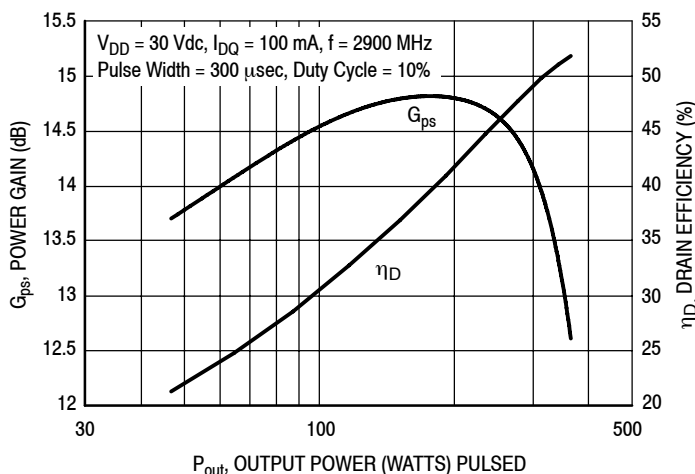

Figure 16. Pulsed Power Gain and Drain Efficiency versus Output Power

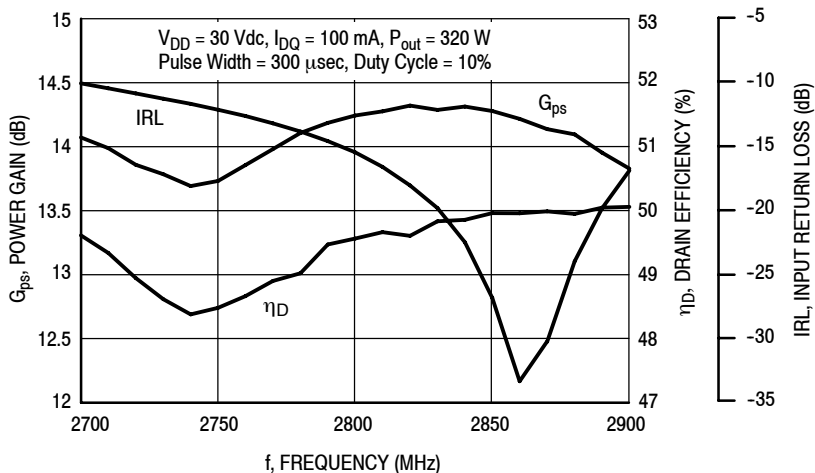

Figure 17. Pulsed Power Gain, Drain Efficiency and Input Return Loss versus Frequency

NOTES:

- 1.0 INTERPRET DIMENSIONS AND TOLERANCES PER ASME Y14.5M-1994.
- 2.0 CONTROLLING DIMENSION: INCH
- 3.0 DIMENSION H IS MEASURED .030 (0.762) AWAY FROM PACKAGE BODY.
- 4.0 RECOMMENDED BOLT CENTER DIMENSION OF 1.52 (38.61) BASED ON M3 SCREW.

STYLE 1:

- PIN 1 - DRAIN
- 2 - DRAIN
- 3 - GATE
- 4 - GATE
- 5 - SOURCE

DIM	INCH		MILLIMETER		DIM	INCH		MILLIMETER	
	MIN	MAX	MIN	MAX		MIN	MAX	MIN	MAX
A	1.615	1.625	41.02	41.28	N	1.218	1.242	30.94	31.55
B	.395	.405	10.03	10.29	Q	.120	.130	3.05	3.3
C	.150	.200	3.81	5.08	R	.355	.365	9.01	9.27
D	.455	.465	11.56	11.81	S	.365	.375	9.27	9.53
E	.062	.066	1.57	1.68					
F	.004	.007	0.1	0.18					
G	1.400 BSC		35.56 BSC		aaa	.013		0.33	
H	.082	.090	2.08	2.29	bbb	.010		0.25	
K	.117	.137	2.97	3.48	ccc	.020		0.51	
L	.540 BSC		13.72 BSC						
M	1.219	1.241	30.96	31.52					
© FREESCALE SEMICONDUCTOR, INC. ALL RIGHTS RESERVED.			MECHANICAL OUTLINE			PRINT VERSION NOT TO SCALE			
TITLE: NI-1230					DOCUMENT NO: 98ASB16977C			REV: E	
					CASE NUMBER: 375D-05			31 MAR 2005	
					STANDARD: NON-JEDEC				

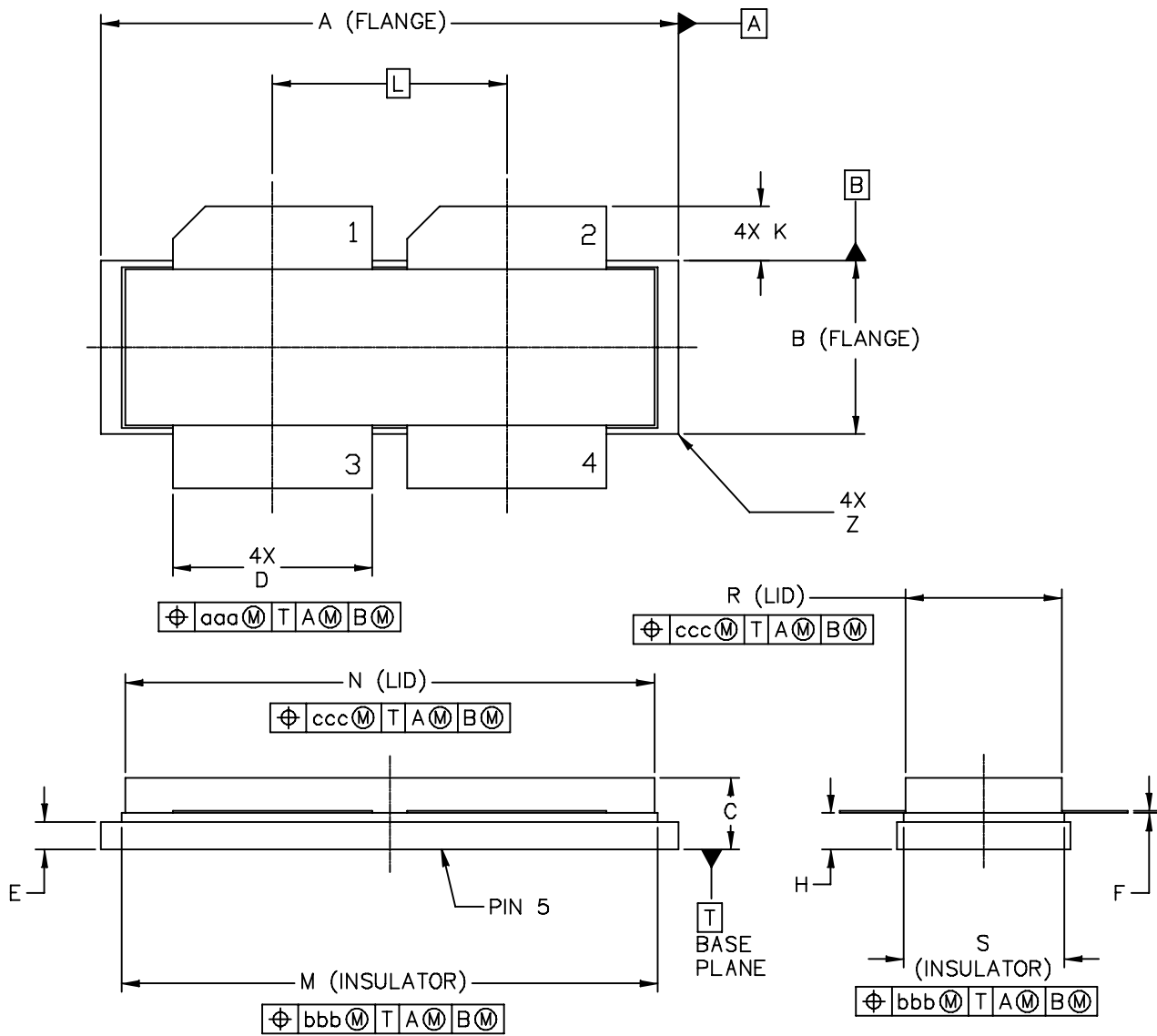

© FREESCALE SEMICONDUCTOR, INC. ALL RIGHTS RESERVED.	MECHANICAL OUTLINE	PRINT VERSION NOT TO SCALE	
TITLE: NI-1230S	DOCUMENT NO: 98ARB18247C	REV: F	
	CASE NUMBER: 375E-04	05 AUG 2005	
	STANDARD: NON-JEDEC		

NOTES:

1. INTERPRET DIMENSIONS AND TOLERANCES PER ASME Y14.5M-1994.
2. CONTROLLING DIMENSION: INCH
3. DIMENSION H IS MEASURED .030 AWAY FROM PACKAGE BODY

STYLE 1:

- PIN 1 - DRAIN
- 2 - DRAIN
- 3 - GATE
- 4 - GATE
- 5 - SOURCE

DIM	INCHES		MILLIMETERS		DIM	INCHES		MILLIMETERS	
	MIN	MAX	MIN	MAX		MIN	MAX	MIN	MAX
A	1.265	1.275	32.13	32.38	R	.355	.365	9.01	9.27
B	.395	.405	10.03	10.29	S	.365	.375	9.27	9.53
C	.150	.200	3.81	5.08	Z	---	.040	---	1.02
D	.455	.465	11.56	11.81					
E	.062	.066	1.57	1.68	aaa	.013		0.33	
F	.004	.007	0.1	0.18	bbb	.010		0.25	
H	.082	.090	2.08	2.29	ccc	.020		0.51	
K	.117	.137	2.97	3.48					
L	.540 BSC		13.72 BSC						
M	1.219	1.241	30.96	31.52					
N	1.218	1.242	30.94	31.55					
© FREESCALE SEMICONDUCTOR, INC. ALL RIGHTS RESERVED.			MECHANICAL OUTLINE			PRINT VERSION NOT TO SCALE			
TITLE: NI-1230S					DOCUMENT NO: 98ARB18247C			REV: F	
					CASE NUMBER: 375E-04			05 AUG 2005	
					STANDARD: NON-JEDEC				

PRODUCT DOCUMENTATION AND SOFTWARE

Refer to the following documents and software to aid your design process.

Application Notes

- AN1955: Thermal Measurement Methodology of RF Power Amplifiers

Engineering Bulletins

- EB212: Using Data Sheet Impedances for RF LDMOS Devices

Software

- Electromigration MTTF Calculator
- RF High Power Model
- .s2p File

For Software, do a Part Number search at <http://www.freescale.com>, and select the “Part Number” link. Go to the Software & Tools tab on the part’s Product Summary page to download the respective tool.

R5 TAPE AND REEL OPTION

R5 Suffix = 50 Units, 56 mm Tape Width, 13 inch Reel.

The R5 tape and reel option for MRF8P29300H and MRF8P29300HS parts will be available for 2 years after release of MRF8P29300H and MRF8P29300HS. Freescale Semiconductor, Inc. reserves the right to limit the quantities that will be delivered in the R5 tape and reel option. At the end of the 2 year period customers who have purchased these devices in the R5 tape and reel option will be offered MRF8P29300H and MRF8P29300HS in the R6 tape and reel option.

REVISION HISTORY

The following table summarizes revisions to this document.

Revision	Date	Description
0	Feb. 2011	• Initial Release of Data Sheet

How to Reach Us:

Home Page:

www.freescale.com

Web Support:

<http://www.freescale.com/support>

USA/Europe or Locations Not Listed:

Freescale Semiconductor, Inc.
Technical Information Center, EL516
2100 East Elliot Road
Tempe, Arizona 85284
1-800-521-6274 or +1-480-768-2130
www.freescale.com/support

Europe, Middle East, and Africa:

Freescale Halbleiter Deutschland GmbH
Technical Information Center
Schatzbogen 7
81829 Muenchen, Germany
+44 1296 380 456 (English)
+46 8 52200080 (English)
+49 89 92103 559 (German)
+33 1 69 35 48 48 (French)
www.freescale.com/support

Japan:

Freescale Semiconductor Japan Ltd.
Headquarters
ARCO Tower 15F
1-8-1, Shimo-Meguro, Meguro-ku,
Tokyo 153-0064
Japan
0120 191014 or +81 3 5437 9125
support.japan@freescale.com

Asia/Pacific:

Freescale Semiconductor China Ltd.
Exchange Building 23F
No. 118 Jianguo Road
Chaoyang District
Beijing 100022
China
+86 10 5879 8000
support.asia@freescale.com

For Literature Requests Only:

Freescale Semiconductor Literature Distribution Center
1-800-441-2447 or +1-303-675-2140
Fax: +1-303-675-2150
LDCForFreescaleSemiconductor@hibbertgroup.com

Information in this document is provided solely to enable system and software implementers to use Freescale Semiconductor products. There are no express or implied copyright licenses granted hereunder to design or fabricate any integrated circuits or integrated circuits based on the information in this document.

Freescale Semiconductor reserves the right to make changes without further notice to any products herein. Freescale Semiconductor makes no warranty, representation or guarantee regarding the suitability of its products for any particular purpose, nor does Freescale Semiconductor assume any liability arising out of the application or use of any product or circuit, and specifically disclaims any and all liability, including without limitation consequential or incidental damages. "Typical" parameters that may be provided in Freescale Semiconductor data sheets and/or specifications can and do vary in different applications and actual performance may vary over time. All operating parameters, including "Typicals", must be validated for each customer application by customer's technical experts. Freescale Semiconductor does not convey any license under its patent rights nor the rights of others. Freescale Semiconductor products are not designed, intended, or authorized for use as components in systems intended for surgical implant into the body, or other applications intended to support or sustain life, or for any other application in which the failure of the Freescale Semiconductor product could create a situation where personal injury or death may occur. Should Buyer purchase or use Freescale Semiconductor products for any such unintended or unauthorized application, Buyer shall indemnify and hold Freescale Semiconductor and its officers, employees, subsidiaries, affiliates, and distributors harmless against all claims, costs, damages, and expenses, and reasonable attorney fees arising out of, directly or indirectly, any claim of personal injury or death associated with such unintended or unauthorized use, even if such claim alleges that Freescale Semiconductor was negligent regarding the design or manufacture of the part.

Freescale™ and the Freescale logo are trademarks of Freescale Semiconductor, Inc. All other product or service names are the property of their respective owners.

© Freescale Semiconductor, Inc. 2011. All rights reserved.

