

## LOW NOISE QUAD OPERATIONAL AMPLIFIERS

- LOW VOLTAGE NOISE :  $4.5\text{nV}/\sqrt{\text{Hz}}$
- HIGH GAIN BANDWIDTH PRODUCT : 15MHz
- HIGH SLEW RATE :  $7\text{V}/\mu\text{s}$
- LOW DISTORTION : 0.002%
- LARGE OUTPUT VOLTAGE SWING : +14.3V/-14.6V
- EXCELLENT FREQUENCY STABILITY
- ESD INTERNAL PROTECTION
  
- MACROMODEL INCLUDED IN THIS SPECIFICATION

### DESCRIPTION

The MC33079 is a monolithic quad operational amplifier particularly well suited for audio applications. It offers low voltage noise ( $4.5\text{nV}/\sqrt{\text{Hz}}$ ) and high frequency performances (15MHz Gain Bandwidth product,  $7\text{V}/\mu\text{s}$  slew rate).

In addition the MC33079 has a very low distortion (0.002%) and excellent phase/gain margins.

The output stage allows a large output voltage swing and symmetrical source and sink currents.

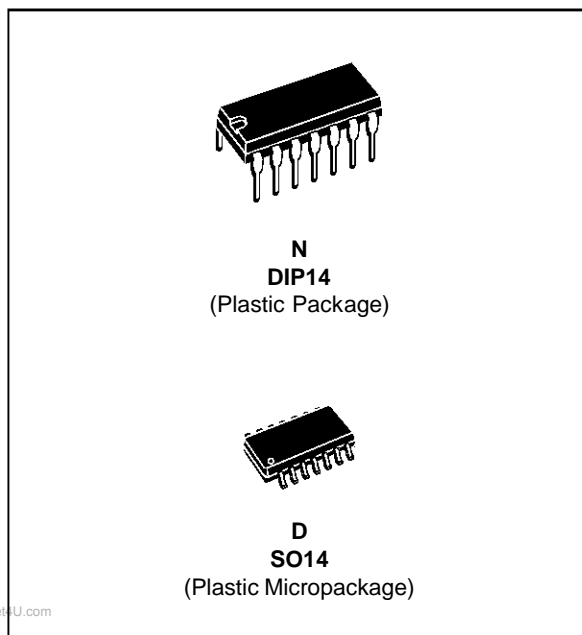

### ORDER CODES

Part Number	Temperature Range	Package	
		N	D
MC33079	-40, +105°C	•	•

### PIN CONNECTIONS (top view)

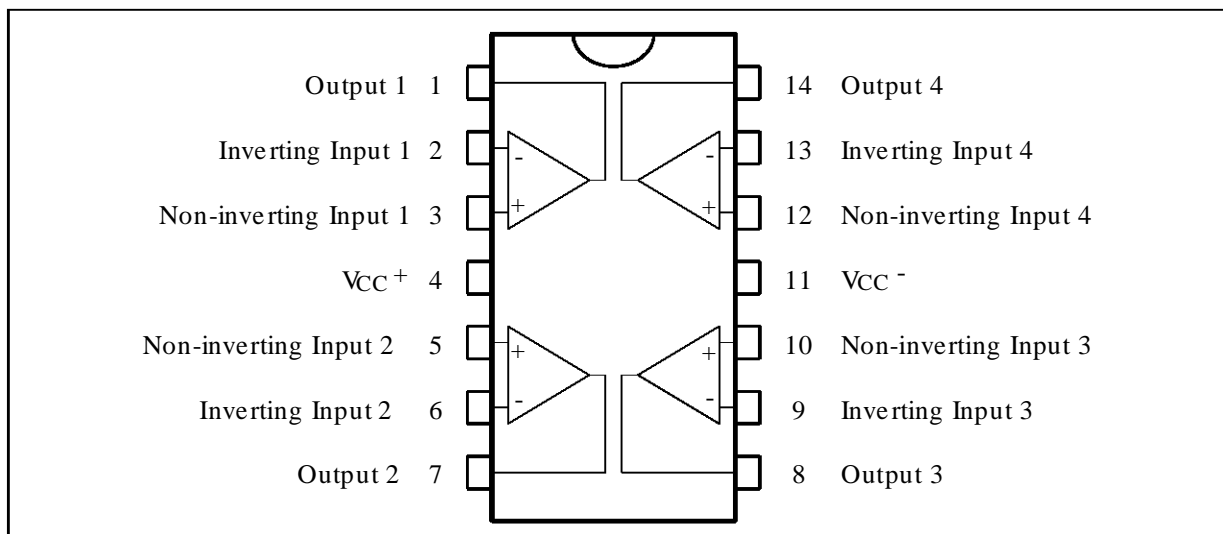

**SCHEMATIC DIAGRAM (1/4 MC33079)**

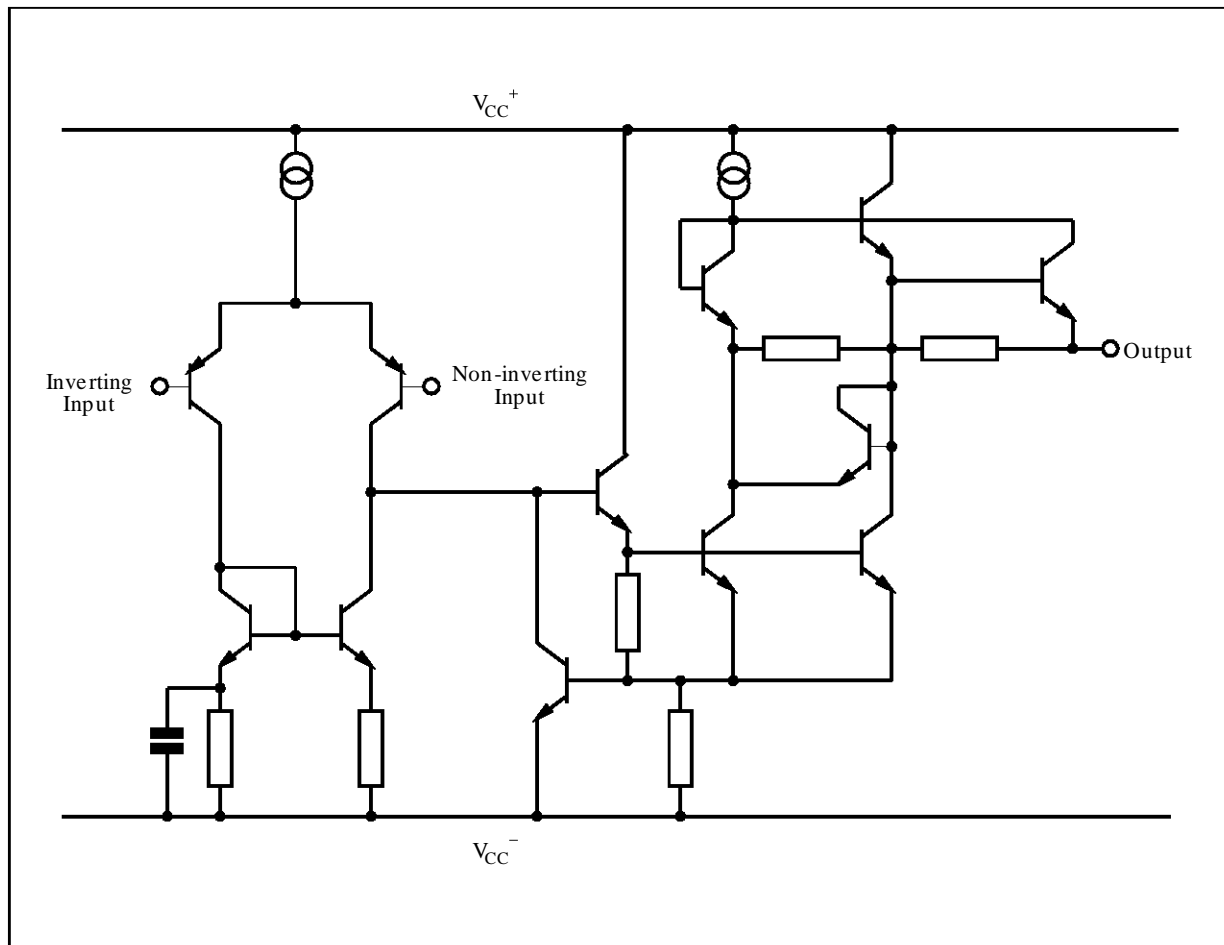

**ABSOLUTE MAXIMUM RATINGS**

Symbol	Parameter	Value	Unit
V <sub>CC</sub>	Supply Voltage	±18 or +36	V
V <sub>id</sub>	Differential Input Voltage - (note 1)	±30	V
V <sub>i</sub>	Input Voltage - (note 1)	±15	V
	Output Short-Circuit Duration - (note 2)	Infinite	
T <sub>oper</sub>	Operating Free-air Temperature Range	-40 to +105	°C
T <sub>j</sub>	Maximum Junction Temperature	+150	°C
T <sub>stg</sub>	Storage Temperature	-65 to +150	°C
P <sub>tot</sub>	Maximum Power Dissipation - (note 2)	500	mW

**Notes :** 1. Either or both input voltages must not exceed the magnitude of V<sub>CC</sub><sup>+</sup> or V<sub>CC</sub><sup>-</sup>  
 2. Power dissipation must be considered to ensure maximum junction temperature (T<sub>j</sub>) is not exceeded

**OPERATING CONDITIONS**

Symbol	Parameter	Value	Unit
V <sub>CC</sub>	Supply Voltage	±2.5 to ±15	V

**ELECTRICAL CHARACTERISTICS**
 $V_{CC}^+ = +15V, V_{CC}^- = -15V, T_{amb} = 25^{\circ}C$  (unless otherwise specified)

Symbol	Parameter	Min.	Typ.	Max.	Unit	
$V_{io}$	Input Offset Voltage ( $V_o = 0V, V_{ic} = 0V$ ) $T_{min.} \leq T_{amb} \leq T_{max.}$			2.5 3.5	mV	
$DV_{io}$	Input Offset Voltage Drift $V_{ic} = 0V, V_o = 0V, T_{min.} \leq T_{amb} \leq T_{max.}$		2		$\mu V/^{\circ}C$	
$I_{io}$	Input Offset Current ( $V_{ic} = 0V, V_o = 0V$ ) $T_{amb} = +25^{\circ}C$ $T_{min.} \leq T_{amb} \leq T_{max.}$		10	150 175	nA	
$I_{ib}$	Input Bias Current ( $V_{ic} = 0V, V_o = 0V$ ) $T_{amb} = +25^{\circ}C$ $T_{min.} \leq T_{amb} \leq T_{max.}$		250	750 800	nA	
$V_{icm}$	Common Mode Input Voltage Range ( $\Delta V_{IO} = 5mV, V_o = 0V$ )	$\pm 13$	$\pm 14$		V	
$A_{vd}$	Large Signal Voltage Gain ( $R_L = 2k\Omega, V_o = \pm 10V$ ) $T_{amb} = +25^{\circ}C$ $T_{min.} \leq T_{amb} \leq T_{max.}$	90 85	100		dB	
$\pm V_{opp}$	Output Voltage Swing ( $V_{id} = \pm 1V$ )  $R_L = 600\Omega$ $R_L = 600\Omega$  $R_L = 2.0k\Omega$ $R_L = 2.0k\Omega$  $R_L = 10k\Omega$ $R_L = 10k\Omega$		12.2 -12.7  14 -14.2  14.3 -14.6		-13.2  -14	V
CMR	Common Mode Rejection Ratio ( $V_{ic} = \pm 13V$ )	80	100		dB	
SVR	Supply Voltage Rejection Ratio $V_{CC}^+ / V_{CC}^- = +15V / -15V$ to $+5V / -5V$	80	105		dB	
$I_o$	Output Short Circuit Current ( $V_{id} = \pm 1V$ , Output to Ground) Source Sink	15 20	29 37		mA	
$I_{CC}$	Supply current ( $V_o = 0V$ , All Amplifiers) $T_{amb} = +25^{\circ}C$ $T_{min.} \leq T_{amb} \leq T_{max.}$		8	10 12	mA	
SR	Slew Rate $V_i = -10V$ to $+10V, R_L = 2k\Omega, C_L = 100pF, A_V = +1$	5	7		V/ $\mu s$	
GBP	Gain Bandwidth Product ( $f = 100kHz, R_L = 2k\Omega, C_L = 100pF$ )	10	15		MHz	
B	Unity Gain Bandwidth (Open loop)		9		MHz	
$A_m$	Gain Margin ( $R_L = 2k\Omega$ ) $C_L = 0pF$ $C_L = 100pF$		-11 -6		dB	
$\phi_m$	Phase Margin ( $R_L = 2k\Omega$ ) $C_L = 0pF$ $C_L = 100pF$		55 30		Degrees	
$e_n$	Equivalent Input Noise Voltage ( $R_S = 100\Omega, f = 1kHz$ )		4.5		$\frac{nV}{\sqrt{Hz}}$	
$i_n$	Equivalent Input Noise current ( $f = 1kHz$ )		0.5		$\frac{pA}{\sqrt{Hz}}$	
THD	Total Harmonic Distortion $R_L = 2k\Omega, f = 20Hz$ to $20kHz, V_o = 3V_{rms}, A_V = +1$		0.002		%	
$V_{O1}/V_{O2}$	Channel Separation ( $f = 20Hz$ to $20kHz$ )		120		dB	
FPB	Full Power Bandwidth ( $V_o = 27V_{pp}, R_L = 2k\Omega, THD \leq 1\%$ )		120		kHz	
$Z_o$	Output Impedance ( $V_o = 0V, f = 9MHz$ )		37		$\Omega$	
$R_i$	Input Resistance ( $V_{ic} = 0V$ )		175		k $\Omega$	
$C_i$	Input Capacitance ( $V_{ic} = 0V$ )		12		pF	

SUPPLY CURRENT vs SUPPLY VOLTAGE

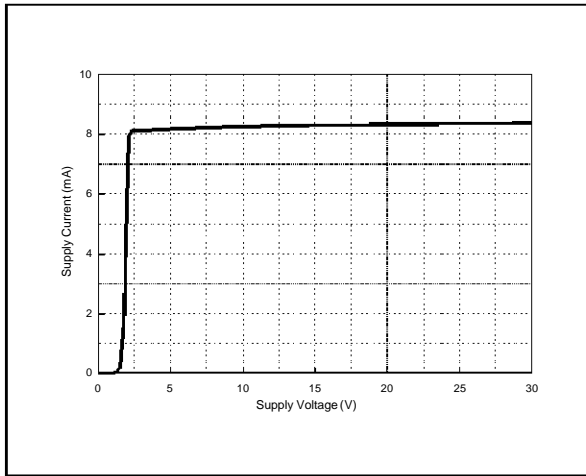

OUTPUT SHORT CIRCUIT CURRENT vs OUTPUT VOLTAGE

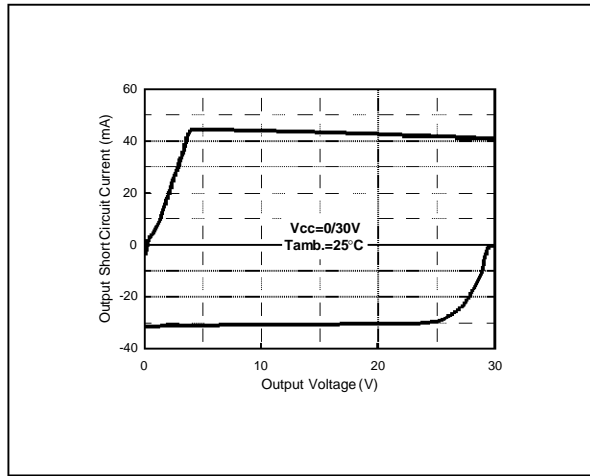

OUTPUT VOLTAGE vs SUPPLY VOLTAGE

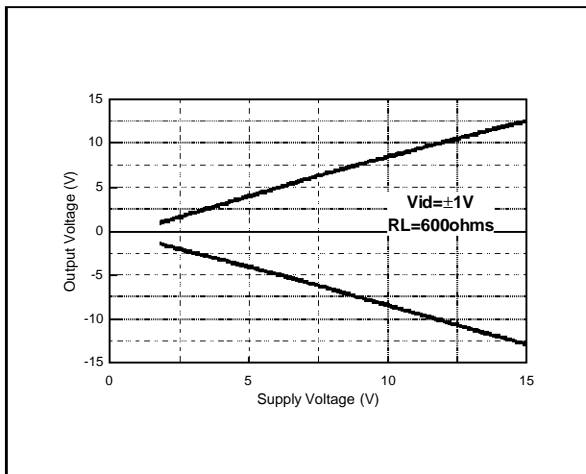

OUTPUT VOLTAGE vs SUPPLY VOLTAGE

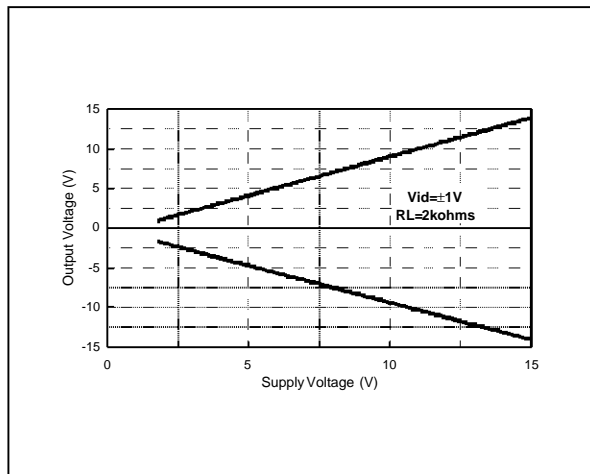

EQUIVALENT INPUT NOISE VOLTAGE vs FREQUENCY

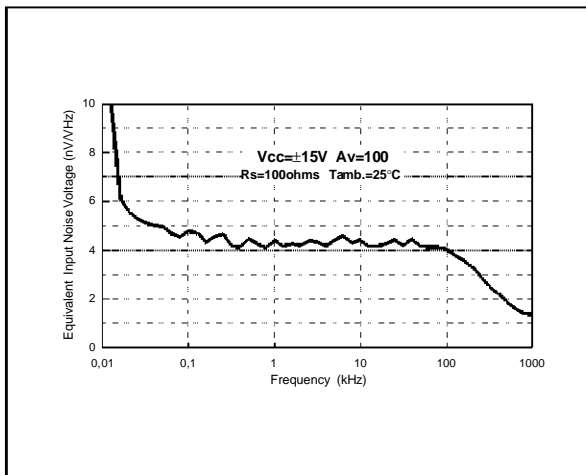

THD + NOISE vs FREQUENCY

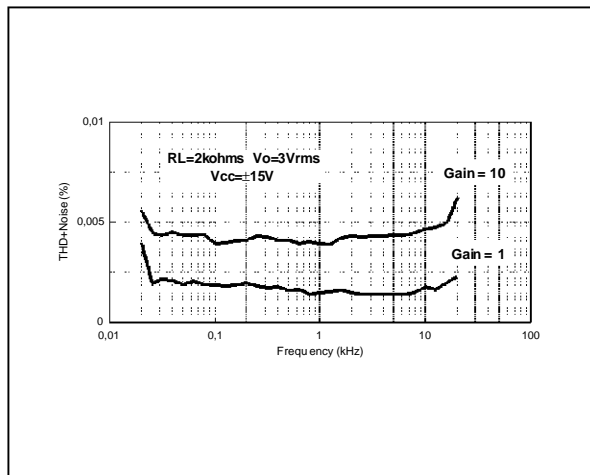

**VOLTAGE GAIN AND PHASE vs FREQUENCY**

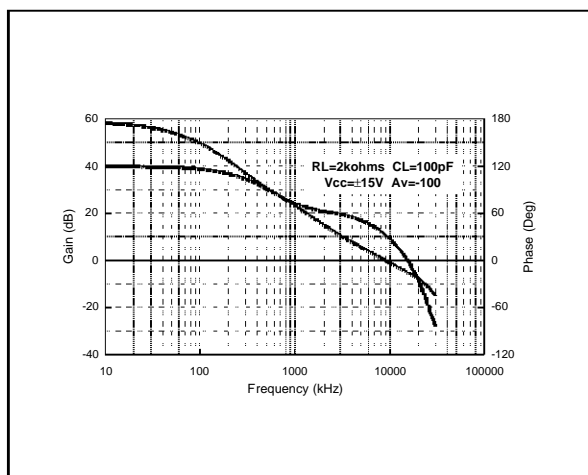

**TOTAL HARMONIC DISTORTION vs OUTPUT VOLTAGE**

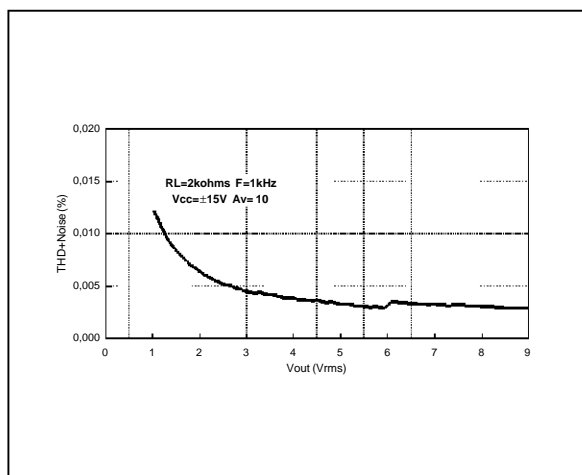

MACROMODEL

- LOW VOLTAGE NOISE :  $4.5nV/\sqrt{Hz}$
- HIGH GAIN BANDWIDTH PRODUCT : 15MHz
- HIGH SLEW RATE :  $7V/\mu s$
- LOW DISTORTION : 0.002%

- LARGE OUTPUT VOLTAGE SWING : +14.3V/-14.6V
- EXCELLENT FREQUENCY STABILITY
- ESD INTERNAL PROTECTION

\*\* StandardLinear Ics Macromodels, 1993.

\*\* CONNECTIONS :

- \* 1 INVERTING INPUT
- \* 2 NON-INVERTING INPUT
- \* 3 OUTPUT
- \* 4 POSITIVE POWER SUPPLY
- \* 5 NEGATIVE POWER SUPPLY

.SUBCKT MC33079 1 3 2 4 5 (analog)

\*\*\*\*\*

\*\*

.MODEL MDTH D IS=1E-8 KF=2.286238E-16 CJO=10F

\* INPUT STAGE

CIP 2 5 1.200000E-11

CIN 1 5 1.200000E-11

EIP 10 5 2 5 1

EIN 16 5 1 5 1

RIP 10 11 2.363636E+00

RIN 15 16 2.363636E+00

RIS 11 15 1.224040E+01

DIP 11 12 MDTH 400E-12

DIN 15 14 MDTH 400E-12

VOFP 12 13 DC 0

VOFN 13 14 DC 0

IPOL 13 5 1.100000E-04

CPS 11 15 2.35E-09

DINN 17 13 MDTH 400E-12

VIN 17 5 1.000000E+00

DINR 15 18 MDTH 400E-12

VIP 4 18 1.000000E+00

FCP 4 5 VOFP 1.718182E+01

FCN 5 4 VOFN 1.718182E+01

FIBP 2 5 VOFN 4.545455E-03

FIBN 5 1 VOFP 4.545455E-03

\* AMPLIFYING STAGE

FIP 5 19 VOFP 9.545455E+02

FIN 5 19 VOFN 9.545455E+02

CC 19 29 1.500000E-08

HZTP 30 29 VOFP 1.523529E+02

HZTN 5 30 VOFN 1.523529E+02

DOPM 51 22 MDTH 400E-12

DONM 21 52 MDTH 400E-12

HOPM 22 28 VOUT 5.172414E+03

VIPM 28 4 1.500000E+02

HONM 21 27 VOUT 4.054054E+03

VINM 5 27 1.500000E+02

DBIDON1 19 53 MDTH 400E-12

V1 51 53 0.68

DBIDON2 54 19 MDTH 400E-12

V2 54 52 0.68

RG11 51 5 3.04E+05

RG12 51 4 3.04E+05

RG21 52 5 0.6072E+05

RG22 52 4 0.6072E+05

E1 50 40 51 0 1 E2 40 39 52 0 1

EDEC1 38 39 4 0 0.5

EDEC2 0 38 5 0 0.5

DOP 51 25 MDTH 400E-12

VOP 4 25 1.474575E+00

DON 24 52 MDTH 400E-12

VON 24 5 1.474575E+00

RAJUS 50 5 1E12

GCOMP 5 4 4 5 8.1566068E-04

RPM1 5 80 1E+06

RPM2 4 80 1E+06

GAVPH 5 82 50 80 3.26E-03

RAVPHGH 82 4 613

RAVPHGB 82 5 613

RAVPHDH 82 83 1000

RAVPHDB 82 84 1000

CAVPHH 4 83 0.159E-09

CAVPHB 5 84 0.159E-09

EOUT 26 23 82 5 1

VOUT 23 5 0

ROUT 26 3 4.780354E+01

COUT 3 5 1.000000E-12

.ENDS

**ELECTRICAL CHARACTERISTICS**

$V_{CC^+} = +15V$ ,  $V_{CC^-} = -15V$ ,  $T_{amb} = 25^{\circ}C$ , (unless otherwise specified)

Symbol	Conditions	Value	Unit
$V_{io}$		0	mV
$A_{vd}$	$R_L = 2k\Omega$ , $V_o = \pm 10V$	100	dB
$I_{CC}$	No load, per operator	2	mA
$V_{icm}$	$\Delta V_{io} = 5mV$ , $V_o = 0V$	28	V
$V_{opp}$	$R_L = 2k\Omega$	28.2	V
$I_{sink}$	$V_o = 0V$	37	mA
$I_{source}$	$V_o = 0V$	29	mA
GBP	$R_L = 2k\Omega$ , $C_L = 100pF$	15	MHz
SR	$R_L = 2k\Omega$ , $C_L = 100pF$ , $A_v = +1$	7	V/ $\mu s$
$\theta_m$	$R_L = 2k\Omega$ , $C_L = 0pF$	55	Degrees

**PACKAGE MECHANICAL DATA**  
14 PINS - PLASTIC DIP

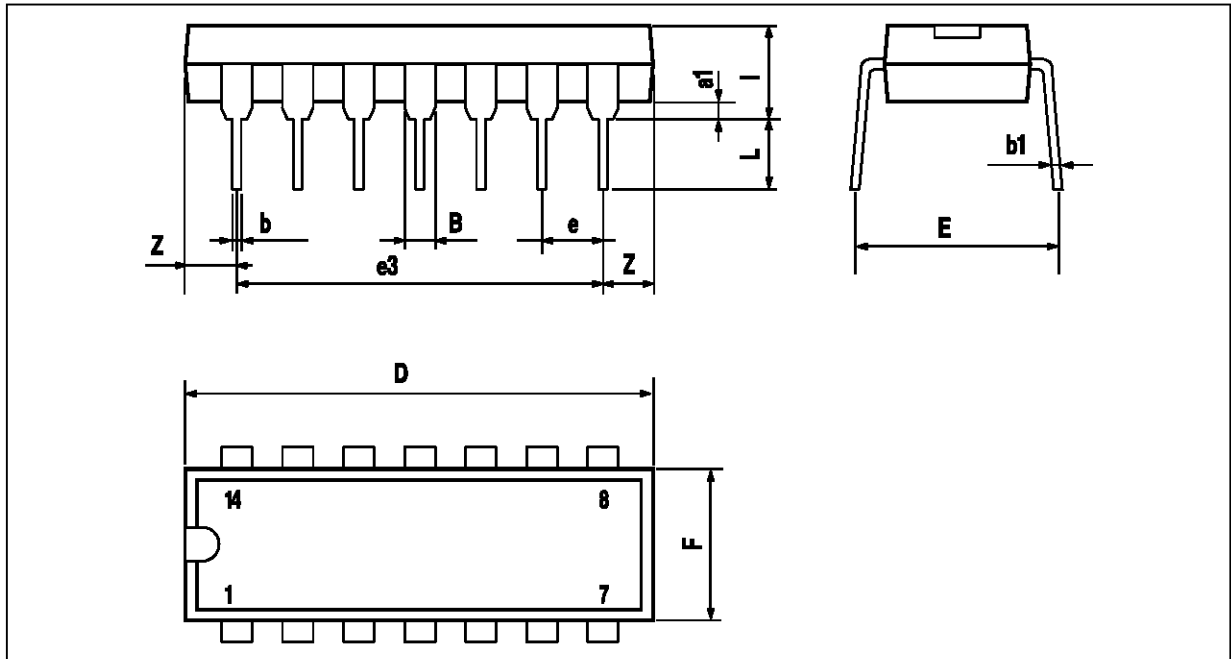

PM-DIP14.EPS

Dimensions	Millimeters			Inches		
	Min.	Typ.	Max.	Min.	Typ.	Max.
a1	0.51			0.020		
B	1.39		1.65	0.055		0.065
b		0.5			0.020	
b1		0.25			0.010	
D			20			0.787
E		8.5			0.335	
e		2.54			0.100	
e3		15.24			0.600	
F			7.1			0.280
i			5.1			0.201
L		3.3			0.130	
Z	1.27		2.54	0.050		0.100

DIP14.TBL



## PACKAGE MECHANICAL DATA

14 PINS - PLASTIC MICROPACKAGE (SO)

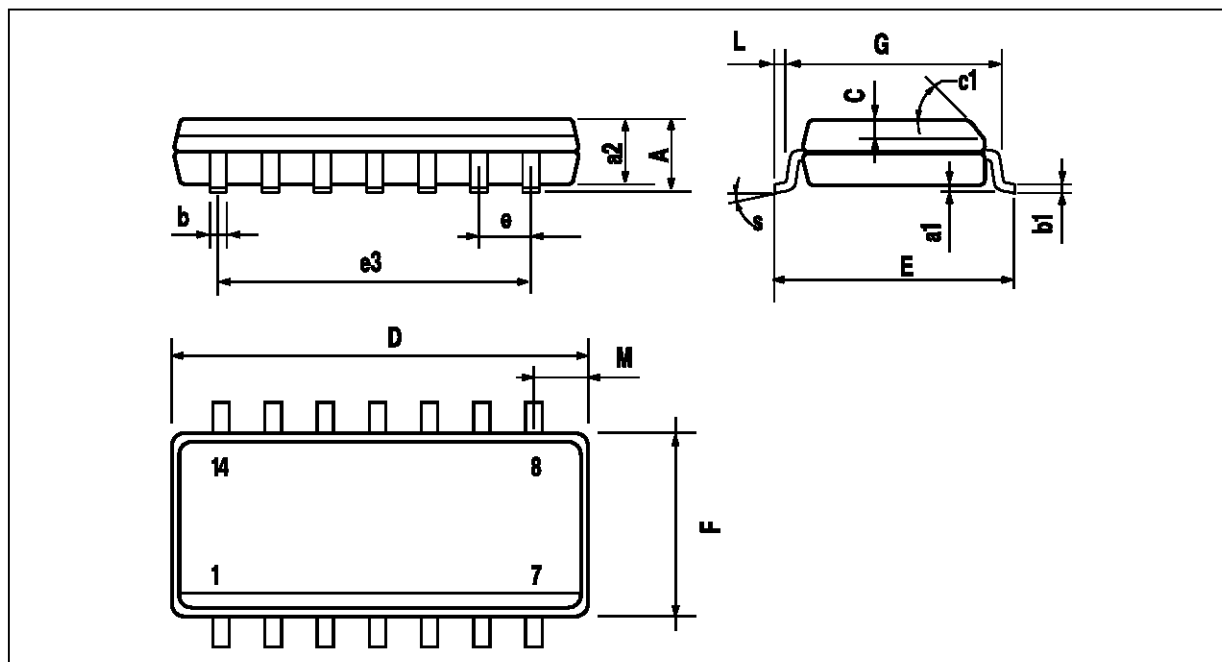

PW-SO14.EPS

Dimensions	Millimeters			Inches		
	Min.	Typ.	Max.	Min.	Typ.	Max.
A			1.75			0.069
a1	0.1		0.2	0.004		0.008
a2			1.6			0.063
b	0.35		0.46	0.014		0.018
b1	0.19		0.25	0.007		0.010
C		0.5			0.020	
c1	45° (typ.)					
D	8.55		8.75	0.336		0.334
E	5.8		6.2	0.228		0.244
e		1.27			0.050	
e3		7.62			0.300	
F	3.8		4.0	0.150		0.157
G	4.6		5.3	0.181		0.208
L	0.5		1.27	0.020		0.050
M			0.68			0.027
S	8° (max.)					

SO14.TBL

Information furnished is believed to be accurate and reliable. However, SGS-THOMSON Microelectronics assumes no responsibility for the consequences of use of such information nor for any infringement of patents or other rights of third parties which may result from its use. No license is granted by implication or otherwise under any patent or patent rights of SGS-THOMSON Microelectronics. Specification mentioned in this publication are subject to change without notice. This publication supersedes and replaces all information previously supplied. SGS-THOMSON Microelectronics products are not authorized for use as critical components in life support devices or systems without express written approval of SGS-THOMSON Microelectronics.

© 1997 SGS-THOMSON Microelectronics – Printed in Italy – All Rights Reserved

SGS-THOMSON Microelectronics GROUP OF COMPANIES  
 Australia - Brazil - Canada - China - France - Germany - Italy - Japan - Korea - Malaysia - Malta - Morocco  
 The Netherlands - Singapore - Spain - Sweden - Switzerland - Taiwan - Thailand - United Kingdom - U.S.A.

ORDER CODE :