

Dielectric Filters

Token Offers Dielectric RF Filters for Telecoms (DF-A)

▶ Preview

Token has extended the capabilities of its filter product line with the introduction of a new range of dielectric microwave filters to the available frequency range up to 5.8GHz. Token designs and manufactures custom electronic filters for defence, telecommunications and similar application increasing the range of products available to customers.



Two block-type dielectric RF filters for telecoms basestation applications have been added to Token's DF range. The filters have been designed for cellular basestation applications that use a digital pre-distortion amplifier (DPD), as they feature a wide pass band and flat ripple performance, which are required for DPD PA design.

Applications also include RF and microwave communications such as GSM, 3G, GPS, satellite and TV transmission, wireless security systems, radar, CT1, CT2, 900MHz, 1.8GHz, 2.4GHz, 5.8GHz Cordless Phone, wireless earphone, wireless microphone, aerospace and military.

The DF-A filter's small size (8.8 x 7.3 x 3.6 mm) means they require more less mounting space compared to Token's previous generation of filters for this application. The filters' highly sophisticated multi-pole design ensures high attenuation and good selectivity. Both the two members of the DF series have a ripple of 1.0 dB max.

In addition, Token enhances custom design capabilities for specialist applications. Our customers will benefit from the additional frequency ranges now available and from the excellent quality and lower costs achievable

Custom parts are available on request. Token will also produce devices outside these specifications to meet specific customer requirements, please contact our sales for more information.

▶ Applications

- Suitable for surface mount and reflow soldering.
- Excellent mechanical structure and temperature stability.
- Good selectivity, low insertion loss for using high Q-value resonators.

Dimensions (Unit: mm)

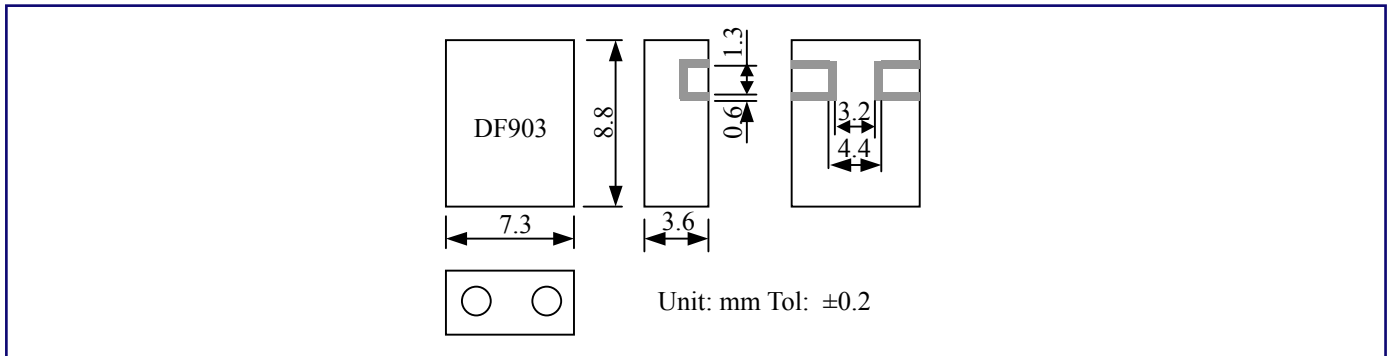

Typical Specifications

Part No.	Center Frequency (MHz)	Band Width (MHz)	Insertion Loss (dB) max.	Ripple in Band Width (dB) max.	V.S.W.R max.	Attenuation (dB) min. (MHz)
DF457S30A	457	fo±15	3.0	1.0	2.0	17 at fo+50; 30 at fo-50
DF522S10A	522	fo±5	3.0	0.5	1.6	23 at fo+40; 40 at fo-40
DF683S30A	683	fo±15	2.5	1.0	2.0	20 at fo+64; 30 at fo-64
DF740S30A	740	fo±15	2.0	0.5	1.8	14 at fo+64; 20 at fo-64
DF864S10A	864	fo±5	2.5	0.5	1.5	15 at fo+24; 17 at fo-24
DF915S25A	915	fo±12.5	2.0	1.0	2.0	20 at fo+100; 35 at fo-100
DF903S6A	903	fo±3	3.5	0.5	1.5	32 at fo+24
DF927S6A	927	fo±3	3.5	0.5	1.5	32 at fo-24
DF1890S80A	1890	fo±40	1.5	1.0	2.0	15 at fo+200; 35 at fo-200
DF2403S20A	2403	fo±10	3.0	0.5	1.5	35 at fo+75
DF2475S20A	2475	fo±10	3.0	0.5	1.5	35 at fo-75

Typical Characteristic

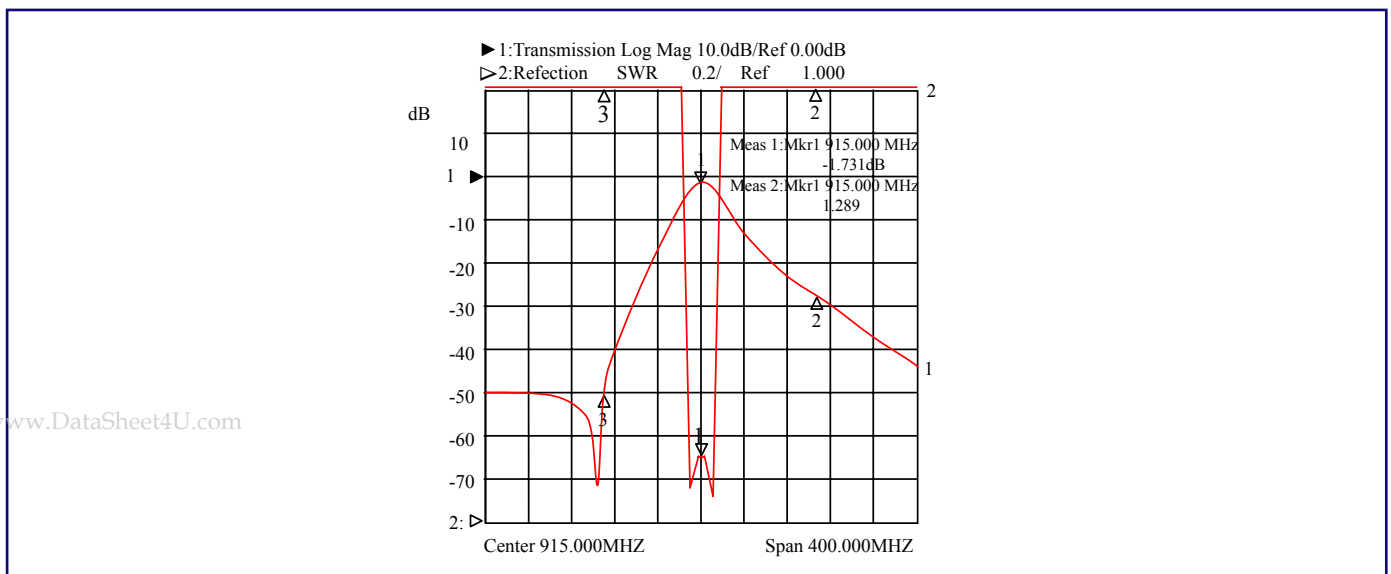

Continued on the following page.

↑ Continued from the preceding page.

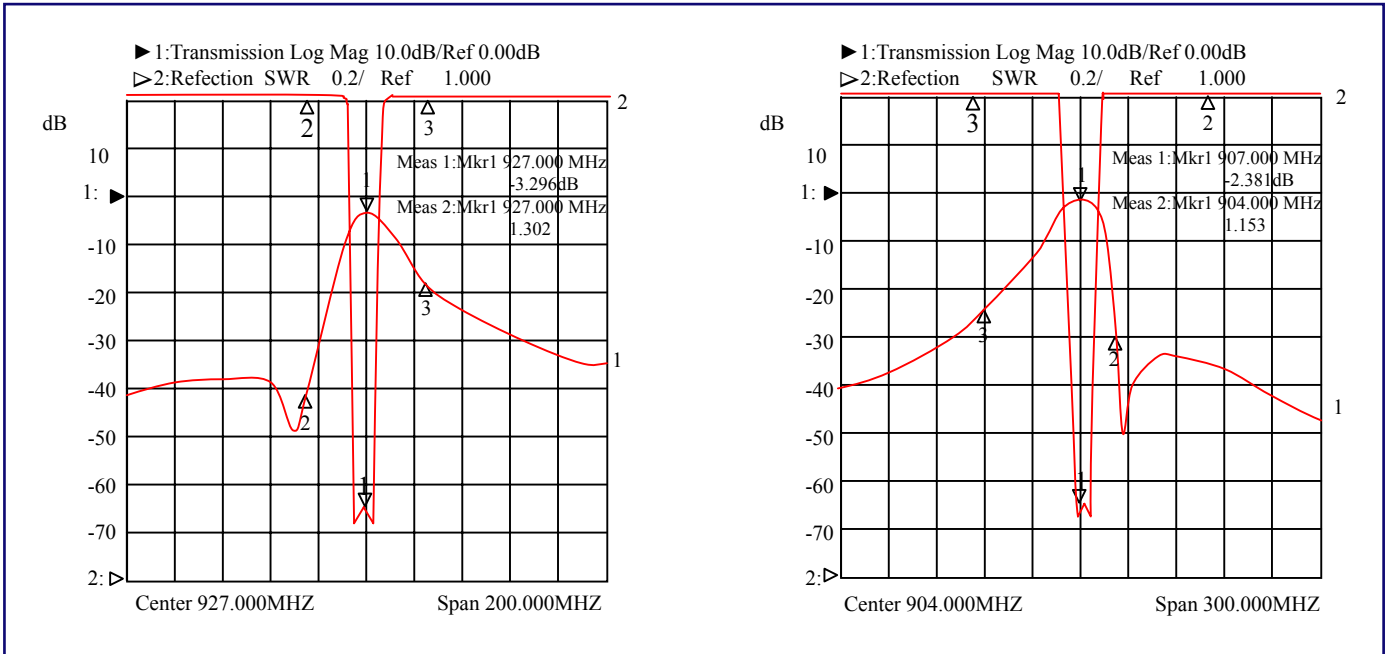

▶ How to Order

- DF
①
- 864
②
- S
③
- 10
④
- A
⑤

- ① Dielectric Filter
- ② Center Frequency
- ③ Connect Type :

Code	Size
S	SMD type

- ④ Bandwidth
- ⑤ Size

Code	Size
A	7.3*3.6 mm
B	6.0*3.0 mm
C	4.5*2.0 mm
D	3.6*1.8 mm

www.DataSheet4U.com

Back to 1st Page - Dielectric Filters DF-A

Dielectric Filters (DF-B)

**Token Dielectric Filter (DF-B)
has a Ripple in Band Width (dB) 0.5 max.**



▶ Preview

Token Dielectric Filter (DF-B) manufactures with a fine-grained, high density, high purity dielectric material to keep the best performance with a ripple in band width (dB) 0.5 max.

The (DF-B) filter's small size (8.5 x 6.0 x 3.0 mm) means they require more less mounting space. Available Center Frequency 650 MHz to 916 MHz with V.S.W.R 1.5 max., insertion loss 2.0 ~ 5.0 (dB) max.

RF dielectric filters are mounted in a surface mount package which assures mechanical stability and excellent lead coplanarity. RF filters can be customized designs and tighter tolerances available on request.

Products conform to the RoHS directive. Application of specific designs also available including different Dielectric values and Q specifications adjusted to frequency requirements.

► Dimensions (Unit: mm)

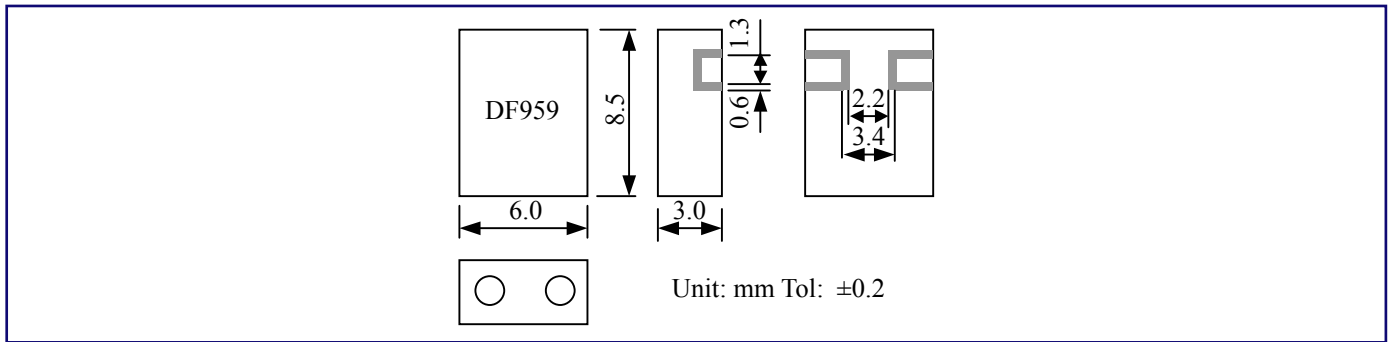

► Typical Specifications

Part No.	Center Frequency (MHz)	Band Width (MHz)	Insertion Loss (dB)max.	Ripple in Band Width (dB)max.	V.S.W.R max.	Attenuation (dB)min.(MHz)
DF650S30B	650	fo±15	2.5	0.5	1.5	19 at fo±64
DF700S20B	700	fo±10	2.5	0.5	1.5	19 at fo±64
DF710S08B	710	fo±4	5.0	0.5	1.5	35 at fo+100; 28 at fo+50
DF746S20B	746	fo±10	2.5	0.5	1.5	12 at fo-20
DF758S16B	758	fo±8	2.5	0.5	1.5	19 at fo±64
DF794S20B	794	fo±10	2.5	0.5	1.5	19 at fo±64
DF800S08B	800	fo±4	5.0	0.5	1.5	35 at fo+100; 28 at fo+50
DF836S20B	836	fo±10	2.5	0.5	1.5	19 at fo+52
DF850S08B	850	fo±4	5.0	0.5	1.5	30 at fo+100; 40 at fo-200
DF863S22B	863	fo±11	2.0	0.5	1.5	50 at fo-90; 20 at fo+90
DF875S24B	875	fo±12	2.3	0.5	1.5	30 at fo-70
DF903S09B	903	fo±4.5	3.5	0.5	1.5	34 at fo-64; 41 at fo+64
DF906S20B	906	fo±10	2.5	0.5	1.5	19 at fo±64
DF916S30B	916	fo±15	2.7	0.5	1.5	20.5 at fo±70

► Typical Characteristic

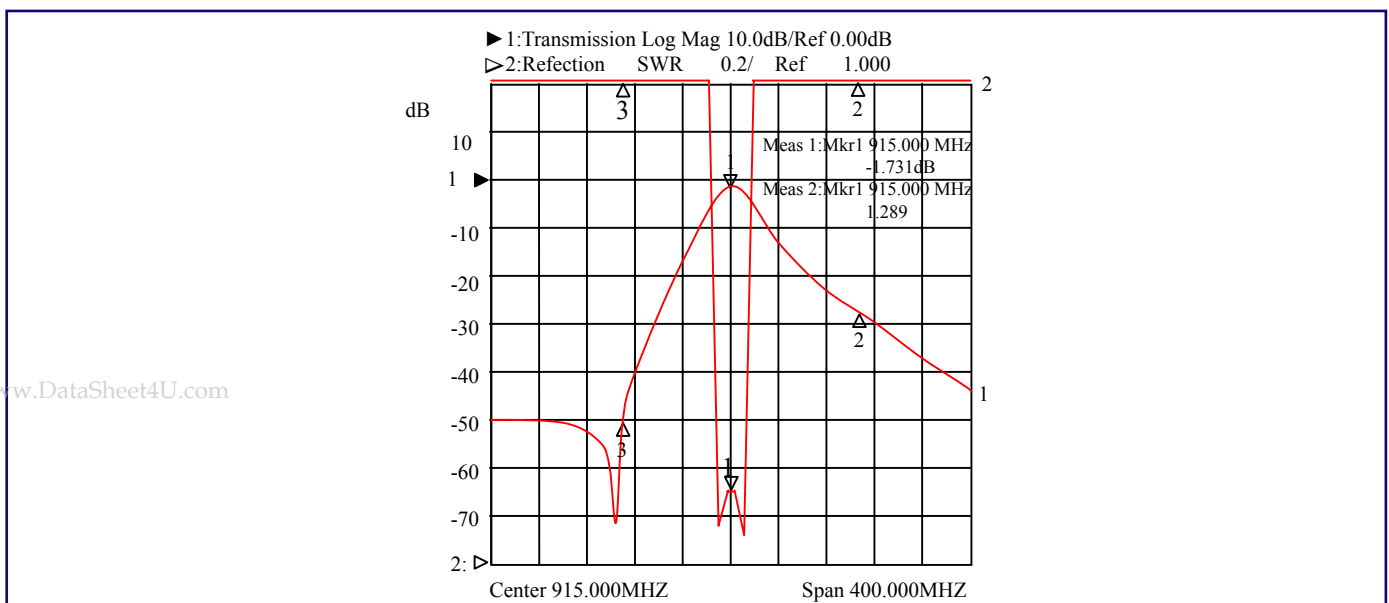

www.DataSheet4U.com

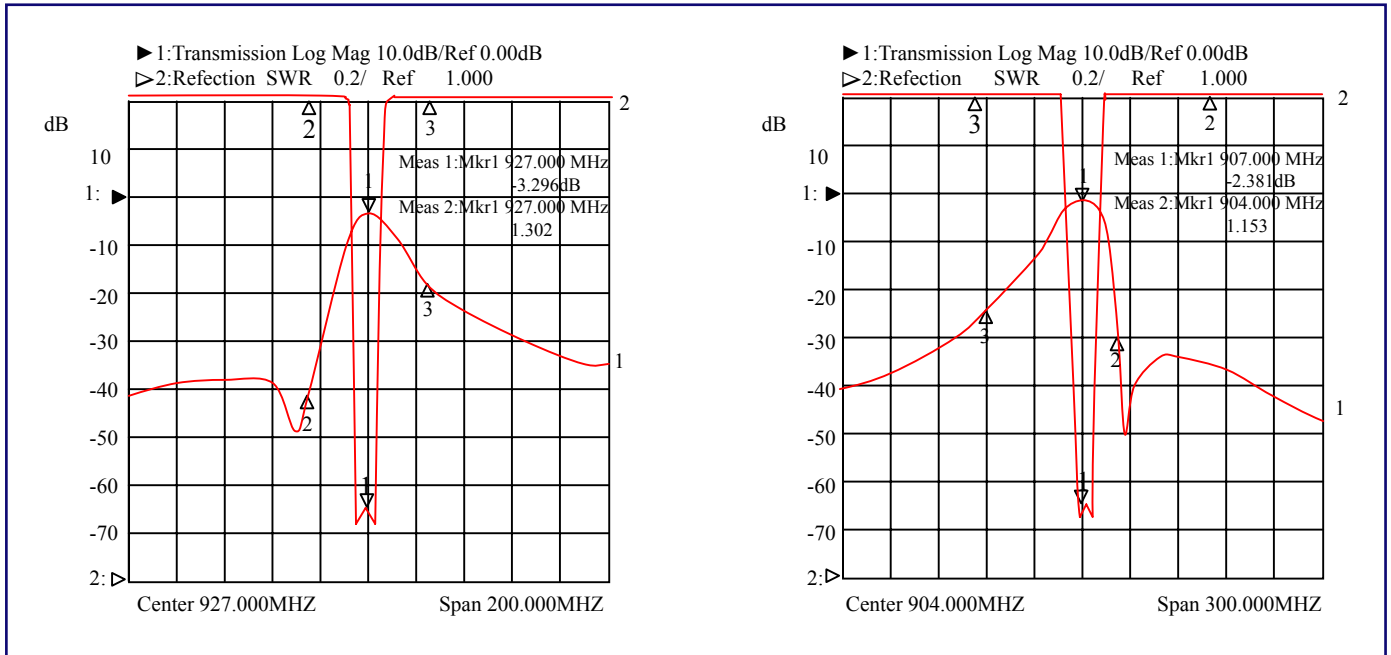

How to Order

- DF
①
- 836
②
- S
③
- 20
④
- B
⑤

- ① Dielectric Filter
- ② Center Frequency
- ③ Connect Type :

Code	Size
S	SMD type

- ④ Bandwidth
- ⑤ Size

Code	Size
A	7.3*3.6 mm
B	6.0*3.0 mm
C	4.5*2.0 mm
D	3.6*1.8 mm

www.DataSheet4U.com

Back to 1st Page - Dielectric Filters DF-B

Dielectric Filters (DF-C/D)

**Token Two Block-Type Dielectric Filters (DF-C/D)
range up to 5.8GHz**



► Preview

Token two block-type dielectric RF filters have been designed for cellular basestation applications that use a digital pre-distortion amplifier (DPD), as they feature a wide pass band and flat ripple performance, which are required for DPD PA design.

Applications also include RF and microwave communications such as satellite and TV transmission, wireless security systems, radar, GSM, 3G, GPS, CT1, CT2, 900MHz, 1.8GHz, 2.4GHz, 5.8GHz Cordless Phone, wireless earphone, wireless microphone, aerospace and military.

The (DF-C/D) filter's small size (4.5 x 4.5 x 2.0 mm) means they require more less mounting space with a ripple of 1.0 dB max and insertion loss 2.0 (dB) max. Center frequency range from 1575 MHz to 5800 MHz with V.S.W.R 2.0 max.

The surface mount RF Dielectric Filters (DF-C/D) conform to the RoHS directive and package is suitable for automatic pick and place equipment which assures mechanical stability and excellent lead coplanarity. Customized designs and tighter tolerances are available on request. Application of specific designs also available including different Dielectric values and Q specifications adjusted to frequency requirements.

▶ Dimensions (Unit: mm)

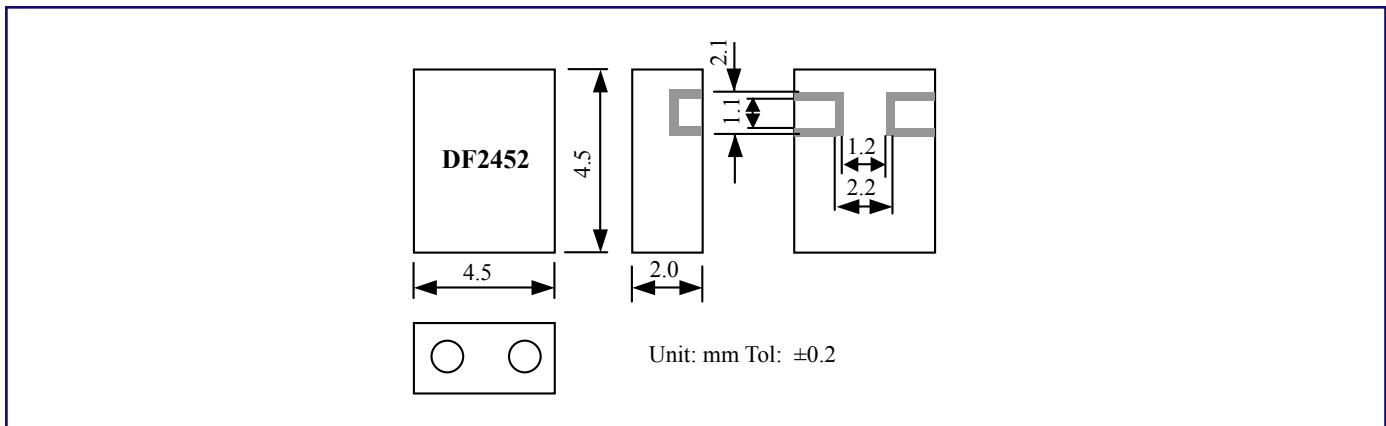

▶ Typical Specifications

Part No.	Center Frequency (MHz)	Band Width (MHz)	Insertion Loss (dB)max.	Ripple in Band Width (dB)max.	V.S.W.R max.	Attenuation (dB)min.(MHz)
DF1575S40C	1575	$f_0 \pm 20$	2.0	0.7	2.0	20 at $f_0 - 100$; 18 at $f_0 + 100$
DF1855S70C	1855	$f_0 \pm 35$	2.0	0.7	2.0	20 at $f_0 + 300$; 20 at $f_0 - 300$
DF1890S80C	1890	$f_0 \pm 40$	2.0	0.7	2.0	15 at $f_0 + 250$; 35 at $f_0 - 250$
DF1950S90C	1950	$f_0 \pm 45$	3.0	0.7	2.0	45 at $f_0 + 975$; 45 at $f_0 - 975$
DF2332S100C	2332	$f_0 \pm 50$	2.5	0.7	2.0	25 at $f_0 + 500$; 40 at $f_0 - 500$
DF2450S100C	2450	$f_0 \pm 50$	2.0	0.7	2.0	12 at $f_0 + 250$; 15 at $f_0 - 250$
DF3066S170D	3066	$f_0 \pm 85$	2.0	1.0	2.0	10 at $f_0 + 300$; 15 at $f_0 - 300$
DF3480S120D	3480	$f_0 \pm 60$	2.0	1.0	2.0	10 at $f_0 + 500$; 20 at $f_0 - 500$
DF3650S150D	3650	$f_0 \pm 75$	2.0	1.0	2.0	15 at $f_0 + 750$; 25 at $f_0 - 750$
DF4880S160D	4880	$f_0 \pm 80$	2.0	1.0	2.0	5 at $f_0 + 350$; 15 at $f_0 - 350$
DF5800S200D	5800	$f_0 \pm 100$	2.0	1.0	2.0	5 at $f_0 + 400$; 15 at $f_0 - 400$

www.DataSheet4U.com

Typical Characteristic

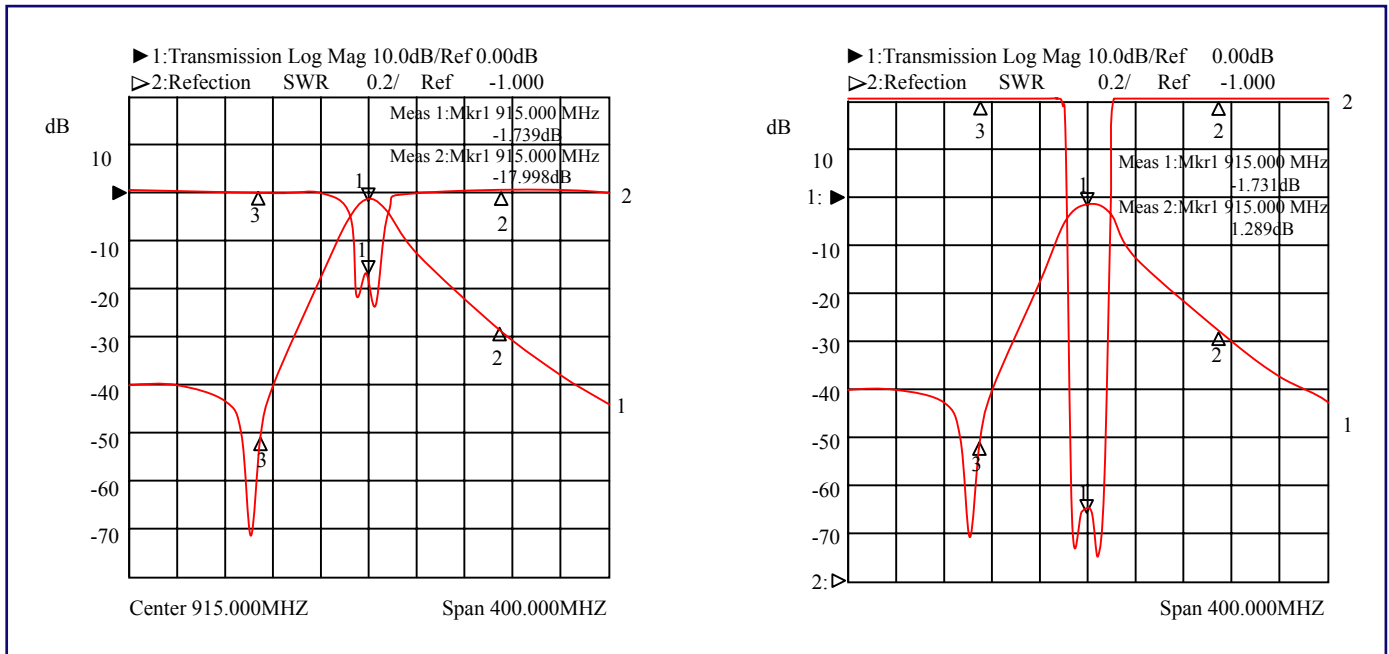

How to Order

- DF
- 1950
- S
- 90
- C

- ❶ Dielectric Filter
- ❷ Center Frequency
- ❸ Connect Type :

Code	Size
S	SMD type

- ❹ Bandwidth
- ❺ Size

Code	Size
A	7.3*3.6 mm
B	6.0*3.0 mm
C	4.5*2.0 mm
D	3.6*1.8 mm

www.DataSheet4U.com

Back to 1st Page - Dielectric Filters DF-C/D

Dielectric Filters (DF 3 or Multi-Pole)

Dielectric Filters (DF) 3 or multi-pole range up to 5.8GHz



▶ Preview

The dielectric filter technology based on high Dielectric Constant (K) ceramic material has been contributing great size reduction of a mobile telecommunication equipment, especially cellular handset and base station. That is superior in electrical performances and reliability. Furthermore it has good mass productivity and low cost.

Token (DF) dielectric filters' highly sophisticated multi-pole design ensures high attenuation and good selectivity. The (DF) multi-pole series filter's small size (8.6 x 9.0 x 3.0 mm) means they require more less mounting space with a ripple of 1.0 dB max. Insertion loss is from 2.0 ~ 3.5 (dB) max. Center frequency range from 860 MHz to 5800 MHz with V.S.W.R 2.0 max.

Coaxial dielectric filter is the most popular and commercially successful technology. Token takes this advance technology to manufacture coaxial type duplexer. This features high unloaded Q, excellent high power performance, flexible design capability, size reduction, low profile, and lighter weight.

Surface mount multi-pole (DF) serie RF filter package is suitable for automatic pick and place equipment which assures mechanical stability and excellent lead coplanarity. Custom designs and tighter tolerances are available on request. Products conform to the RoHS directive.

Token will also produce devices outside these specifications to meet specific customer requirements, please contact our sales for more information.

www.DataSheet4U.com

▶ Features

- MBP 42R Series.
- Murata DFC Series Compatible.
- Application for CT1, CT2, 900MH, 1.8GHz, 2.4G WLL Cordless phone.

► Dimensions (Unit: mm)

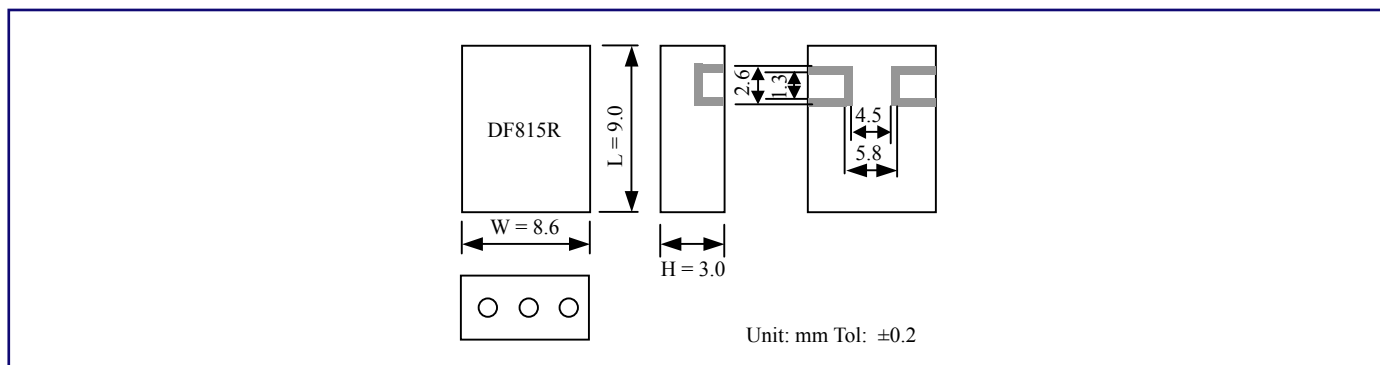

► Typical Specifications

Part No.	Center Frequency fo(MHz)	Band Width (MHz)	Insertion Loss (dB) max.	Ripple in Band Width (dB)max.	V.S.W.R max.	Attenuation (dB) min.(MHz)
DF43R860S20A	860	fo±10	3.0	0.8	2.0	-25 at fo+30 -22 at fo-30
DF43R1855S10A	1855	fo±5	3.5	1.0	2.0	-30 at fo+100 -28 at fo-100
DF43R950S20A	950	fo±10	3.5	0.8	2.0	-40 at fo+30 -35 at fo-30
DF44R3120S60A	3120	fo±30	3.0	1.0	1.5	-58 at fo+355 -55 at fo-375
DF45R1120S40A	1120	fo±20	2.5	1.0	2.0	-50 at fo+50 -50 at fo-50
DF33R815S20B	815	fo±10	2.5	0.8	2.0	-18 at fo+40 -25 at fo-40
DF33R1880S50B	1880	fo±25	3.5	1.0	2.0	-40 at fo+150 -40 at fo-150
DF23R1480S40C	1480	fo±20	2.5	1.0	2.0	-20 at fo+150 -20 at fo-150
DF23R1960S60C	1960	fo±30	2.0	1.0	2.0	-20 at fo+200 -20 at fo-200
DF23R2480S30C	2480	fo±15	2.5	1.0	2.0	-20 at fo+250 -20 at fo-250
DF23R5800S200D	5800	fo±100	2.0	1.0	2.0	-5 at fo+400 -15 at fo-400

www.DataSheet4U.com

Typical Characteristic

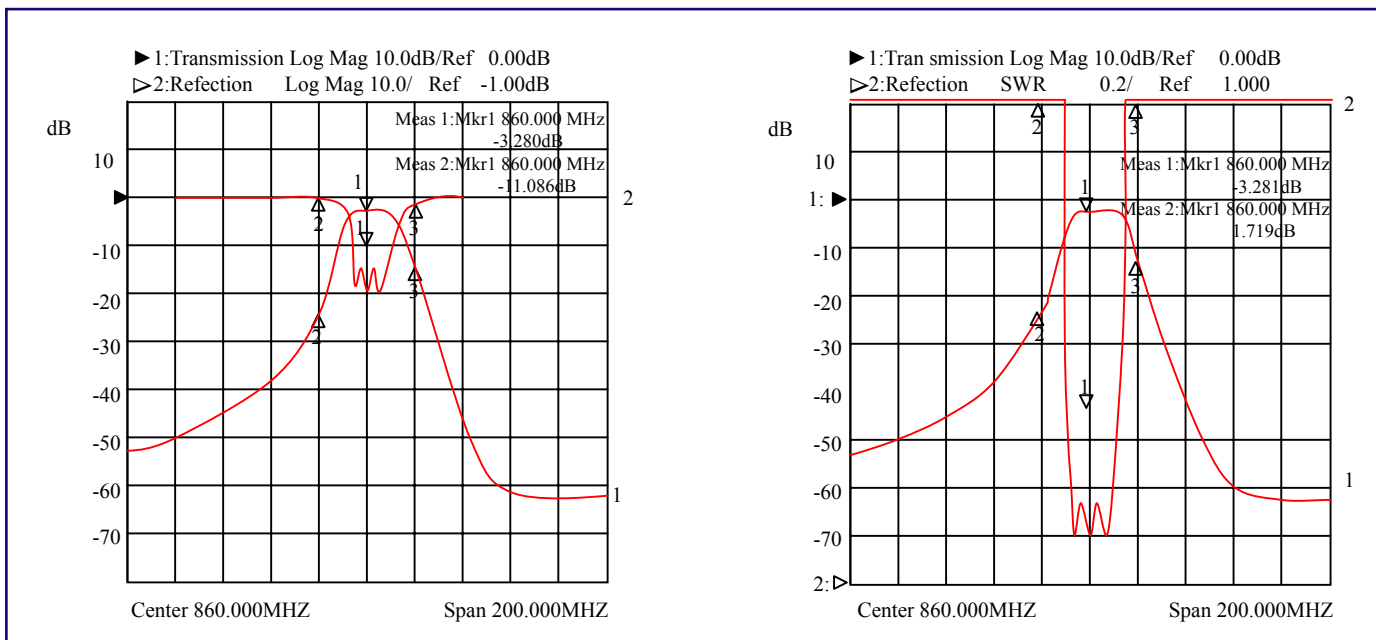

How to Order

- DF
①
- 3
②
- 3R
③
- 815
④
- S
⑤
- 20
⑥
- B
⑦

① Dielectric Filter

② Thickness

Code	Thickness
4	3.8mm
3	3.0mm
2	2.0mm

③ Number of Resonator

④ Center Frequency (MHz)

⑤ Connect type

Code	Connect type
S	SMD type

⑥ Band width (MHz)

⑦ Size(W×H)(mm)

Code	Size(W×H)(mm)
A	11.8×3.8
B	8.6×3.0
C	5.8×2.0

Dielectric Bandpass Filters (BP-R)

**Dielectric Bandpass Filters (BP-R)
Have a Low Ripple In Bandwidth 0.5 (dB) Max.**

▶ Preview

Dielectric bandpass filters, known as ceramic bandpass filters, dielectric ceramic filters, or microwave ceramic filters in standard resonator sizes. Token BP-R series center frequency range is from 915 MHz to 1220 MHz basic rules of ceramic band-pass filters and diplexer. Insertion loss is from 2.0 ~ 3.5 (dB) max and a ripple in bandwidth 0.5 (dB) max.

The higher the Q-factor of a resonators/band pass filters, the better electrical performance for insertion loss. The more dielectric resonators combined together for a band pass ceramic filters, the better rejection, attenuation, and stopband will be. Determinant factor for Insertion Loss Q factor of a resonator, the bandwidth of a filter, and the number of resonators Determinant factor for Attenuation/rejection The number of resonators, connection type of resonators.

Token RF ceramic bandpass filters can be customized designs and tighter tolerances available on request. Token BP-R series are primarily designed for high dielectric constant lines and conform to the RoHS directive.

The (BP-R) series feature with high permittivity, high dielectric constants, extremely temperature stability and high Q that enables the design of stable microwave oscillators and filters. High dielectric constant (K) materials and associated products are also available for custom application requirements.

Please contact our sales for more information.

▶ Features

- Low insertion loss.
- Size small and light.
- High frequency selectivity.
- Temperature compensated.

▶ Applications

www.DataSheet4U.com

- Trunked radio system.
- Cellular, cordless phone.
- Military affairs, Base station.



▶ Dimensions (Unit: mm)

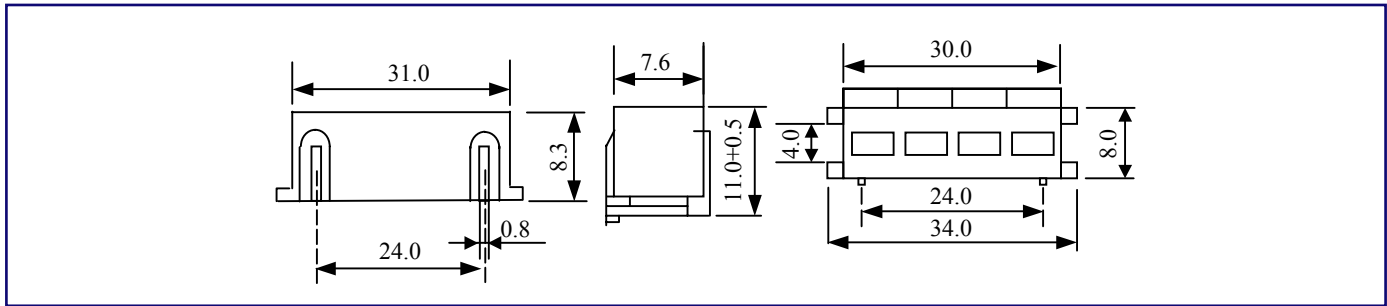

▶ Typical Specifications

Part Number	Center Frequency fo(MHz)	Band Width (MHz)	Insertion Loss (dB)max.	Ripple in Band Width(dB)max.	V.S.W.R max.	Attenuation (dB)min.(MHz)
BP63R915-01	915	fo±5	2.5	0.5	1.5	45 at fo±100
BP64R881-02	881	fo±10	2.0	0.5	2.0	60 at fo±100
BP84R650-01	650	fo±5	2.5	0.5	1.5	70 at fo ±55
BP84R1200-03	1200	fo±15	2.0	0.5	2.0	70 at fo ±60
BP74R959-02	959	fo±10	2.0	0.5	2.0	70 at fo ±80
BP75R836-01	836	fo±5	3.5	0.5	1.5	80 at fo ±50
BP76R1220-02	1220	fo±10	2.5	0.5	2.0	80 at fo ±50

▶ How to Order

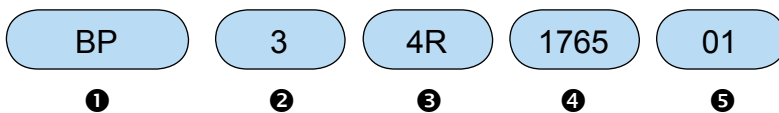

- ❶ Band Pass Filter
- ❷ Thickness
- ❸ Number of Resonator
- ❹ Center Frequency (MHz)
- ❺ BandWidth

Code	BandWidth
01	10MHz
02	20MHz
03	30MHz

Back to 1st Page - Dielectric Band Pass Filters - BP-R

Dielectric Filters (LJ)

Low Insertion Loss Type Dielectric Filters (LJ) Series

▶ Preview

Token electronics manufacturing microwave dielectric filters, multi-layer filters, cavity filters, band-pass filter, military filters, high-frequency filters and so on, using high dielectric coefficient material and dielectric ceramics to meet specific design requirements, in line with RoHS standard.

Surface mount RF dielectric filters are mounted in a through hole package which assures mechanical stability and excellent lead coplanarity. RF dielectric filters can be customized designs and tighter tolerances available on request. Products conform to the RoHS directive and Lead-free.

LJ Series with a stable temperature coefficient, small size, high stability, low insertion loss, good weldability. Dielectric band-pass filter for use in microwave communications, data transmission, radar, electronic warfare, military, aerospace and other fields.

▶ Features

- Low insertion loss.
- Temperature compensated.
- High frequency selectivity.
- small and light.

▶ Applications

- Base station.
- Military affairs.
- Trunked radio system.
- Cellular, Cordless phone.



www.DataSheet4U.com

Dimensions (Unit: mm)

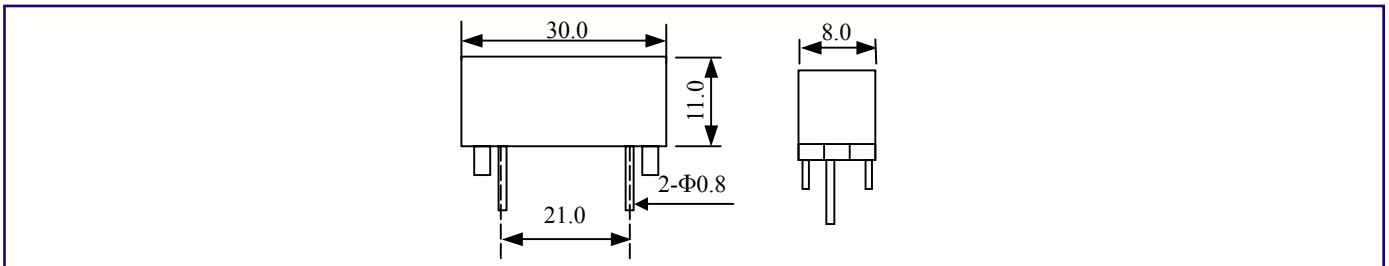

Typical Specifications

Part No.	Center Frequency fo(MHz)	Band Width (MHz)	Insertion Loss (dB) max.	Ripple in Band Width(dB)max.	V.S.W.R max.	Attenuation (dB) min.(MHz)
LJ900-C-A	900	fo±10	2.5	0.5	1.5	50 at fo±100
LJ1200-C-B	1200	fo±15	2.0	0.8	2.0	50 at fo±110
LJ950-D-B	950	fo±10	2.5	0.5	1.5	60 at fo ±100
LJ1250-D-B	1250	fo±15	2.0	0.8	2.0	60 at fo ±110

Typical Characteristic

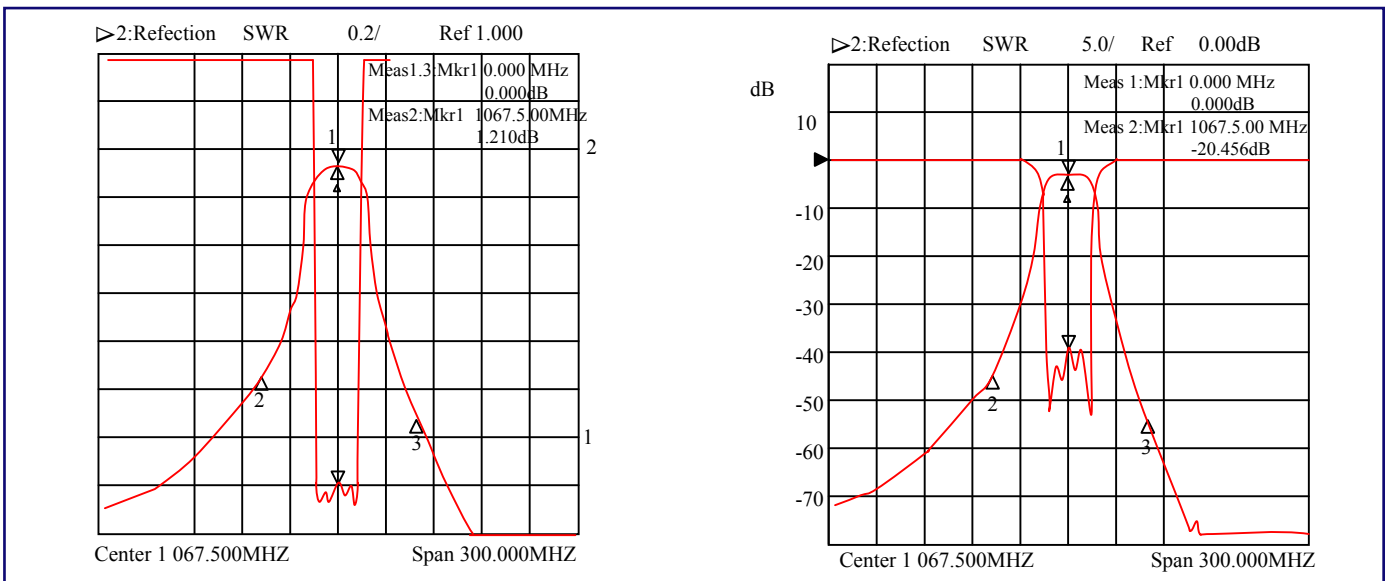

How to Order

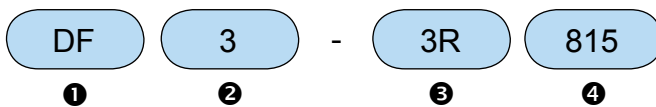

① Dielectric Filter

③ Number of Resonator

Code	Number of Resonator
C	3
D	4

② Center Frequency (MHz)

④ Band Width

Code	Band Width
A	10 MHz
B	20 MHz

Back to 1st Page - Dielectric Filters - LJ

Dielectric BandPass Filters (BP-S)

Token (BP-S) Series For High Performance Microwave Filters and Oscillators

▶ Preview

BP-S series of microwave dielectric bandpass filter series with a high dielectric constant, is the best microwave filters and oscillators.

Token Ceramic Dielectric material has a high dielectric constant and high Q values, and high temperature stability, especially for the design and stability of the microwave oscillations and filtering. German bond ceramic media for CT1, CT2, 900MHz, 1.8GHz, 2.4GHz, 5.8GHz cordless phones, wireless headsets, wireless microphones.

Token electronics manufacturing microwave dielectric filters, multi-layer filters, cavity filters, band-pass filter, military filters, and high-frequency filters, using low insertion loss, high Q, high frequency selectivity, and microwave dielectric ceramics to meet specific design requirements. Comply with RoHS standards.

BP-S series of dielectric filters and stable temperature coefficient, small size and high stability, low insertion loss and good weldability. Dielectric band-pass filter for use in microwave communications, data transmission, radar, electronic warfare, military, aerospace and other fields.

Custom parts are available on request. Token will also produce devices outside these specifications to meet specific customer requirements, please contact our sales for more information.

▶ Features

- Low insertion loss.
- High frequency selectivity.
- Temperature compensated.
- SMD Package, small and light.

▶ Applications

www.DataSheet4U.com

- Base station.
- Military affairs.
- Trunked radio system.
- Cellular, Cordless phone.



▶ Dimensions (Unit: mm)

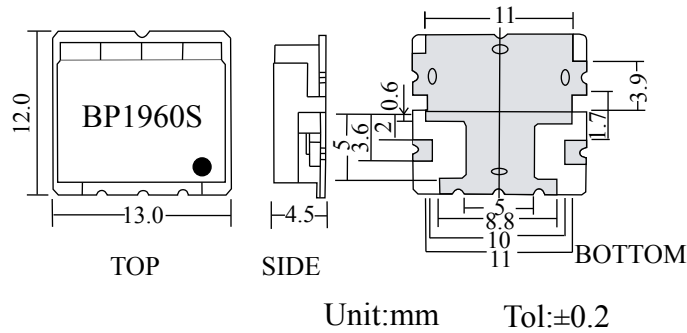

▶ Typical Specifications

Part No.	Center Frequency fo(MHz)	Band Width (MHz)	Insertion Loss (dB)max.	Ripple in Band Width(dB)max.	V.S.W.R max.	Attenuation (dB)min.(MHz)
BP33R881S30A	881.5	fo±12.5	2.5	1.0	1.8	53 at fo±779
BP64R836S30A	836.5	fo±15	3.0	1.2	1.7	18 at fo±32.5
BP64R881S30A	881.5	fo±15	3.0	1.2	1.7	18 at fo ±32.5
BP34R1765S30A	1765	fo±15	3.5	1.0	1.8	30 at fo ±90
BP34R1855S30A	1855	fo±15	3.5	1.0	1.8	30 at fo ±90
BP55R1750S60A	1750	fo±30	3.0	1.5	1.7	30 at fo ±1810
BP55R1765S10A	1765	fo±5	5.0	1.0	1.8	20 at fo ±20
BP55R1765S30A	1765	fo±15	3.0	1.3	1.6	40 at fo ±80
BP55R1855S10A	1855	fo±5	5.0	1.0	1.8	20 at fo ±20
BP55R1855S30A	1855	fo±15	3.8	1.3	1.6	40 at fo ±80
BP66R1755S10A	1755	fo±5	10.0	1.0	2.0	22at fo ±1765
BP66R1845S10A	1845	fo±4.5	13.0	3.0	2.0	28 at fo ±1855
BP34R2315S30A	2315	fo±15	2.7	1.0	1.7	40 at fo ±160
BP34R2385S30A	2385	fo±15	2.7	1.0	1.7	40 at fo ±160
BP34R2442S80A	2442	fo±42	2.5	1.0	1.7	40 at fo ±160
BP64R409S10A	409.5	fo±3.5	3.0	0.8	1.7	30 at fo ±423
BP64R426S10A	426.5	fo±3.5	3.0	0.8	1.7	30 at fo ±413
BP66R1410S30A	1410	fo±14.5	3.0	1.0	1.5	18 at fo ±34.5
BP86R1474S10A	1474	fo±2.5	12.0	2.8	2.0	15 at fo ±10
BP34R1880S60A	1880	fo±32.5	2.5	1.0	1.5	18 at fo ±100
BP34R1960S60A	1960	fo±32.5	3.0	1.0	1.4	45 at fo ±130
BP34R1950S60A	1950	fo±30	3.0	1.0	1.8	38 at fo ±60
BP34R2140S60A	2140	fo±30	3.0	1.0	1.8	38 at fo ±60

▶ How to Order

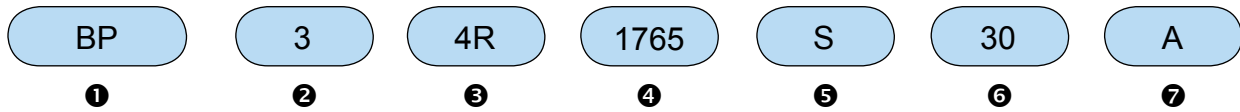

- ❶ Band Pass Filter
- ❷ Thickness
- ❸ Number of Resonator
- ❹ Center Frequency (MHz)
- ❺ Connect type s: SMD type
- ❻ BandWidth

Code	BandWidth
10	10MHz
30	30MHz
60	60MHz

- ❼ Version