

Features

- **Third Generation Programmable Logic Structure**
High Density Replacement for Discrete Logic
- **High Speed - Plus a New Low Power Version**
- **Increased Logic Flexibility**
42 Inputs and 20 SUM terms
- **Flexible Output Logic**
20 Flip-Flops - 10 Extra
All Can Be Individually Buried or 10 Output Directly
Each has Individual Asynchronous Reset or Clock Terms
- **Multiple Feedback Paths Provide for Buried State Machines and I/O Bus Compatibility**
- **Proven and Reliable High Speed CMOS EPROM Process**
2000 V ESD Protection
200 mA Latchup Immunity
- **Reprogrammable - Tested 100% for Programmability**
- **24-pin, 300-mil Dual-in-Line and 28-Lead Surface Mount Packages**

**High Density
UV Erasable
Programmable
Logic Device**

7

Logic Diagram

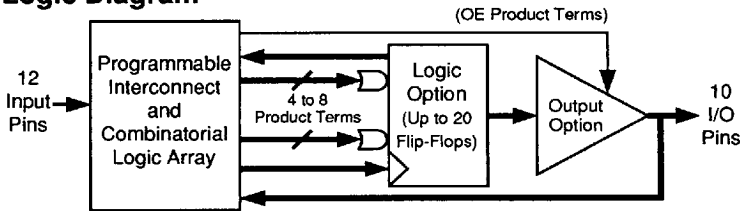

Description

The ATV750/L is 100% more powerful than most other programmable logic devices in 24 pin packages. Increased Product terms, SUM Terms, and Flip-Flops translate into more usable gates.

Each of the ATV750's 22 logic pins can be used as an input. Ten of these can be used as input, output, or bi-directional I/O pins. All 20 Flip-Flops can be fed back into the array independently. This flexibility allows burying all of the SUM terms and Flip-Flops.

There are 171 Product Terms available. A variable format is used to assign between four and eight Product Terms per Sum Term. There are two Sum Terms per output, providing added flexibility. Much more logic can be replaced by this one 24-pin device.

The ATV750/L has more flip-flops available than other EPLDs in this density range. Complex state machines are easily implemented.

Product terms are available providing Asynchronous Resets, Flip-Flop clocks, and Output Enables. One reset and one clock term are provided per Flip-Flop, with one Enable term per output. One product term provides a global synchronous Preset. Register Preload simplifies testing. The device has an internal power up clear function.

Pin Configurations

Pin Name	Function
IN	Logic Inputs
I/O	Bidirectional Buffers
*	No Internal Connection
VCC	+5V Supply

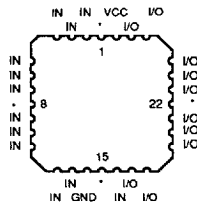
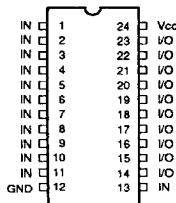

1074177 0005465 883

Absolute Maximum Ratings*

Temperature Under Bias.....	-55°C to +125°C
Storage Temperature.....	-65°C to +150°C
Voltage on Any Pin with Respect to Ground.....	-2.0 V to +7.0 V ⁽¹⁾
Voltage on Input Pins with Respect to Ground During Programming.....	-2.0 V to +14.0 V ⁽¹⁾
Programming Voltage with Respect to Ground.....	-2.0 V to +14.0 V ⁽¹⁾
Integrated UV Erase Dose.....	7258 W-sec/cm ²

*NOTICE: Stresses beyond those listed under "Absolute Maximum Ratings" may cause permanent damage to the device. This is a stress rating only and functional operation of the device at these or any other conditions beyond those indicated in the operational sections of this specification is not implied. Exposure to absolute maximum rating conditions for extended periods may affect device reliability.

Note:

1. Minimum voltage is -0.6 V dc which may undershoot to -2.0 V for pulses of less than 20 ns. Maximum output pin voltage is $V_{CC}+0.75$ V dc which may overshoot to +7.0 V for pulses of less than 20 ns.

Logic Options

Combined Terms

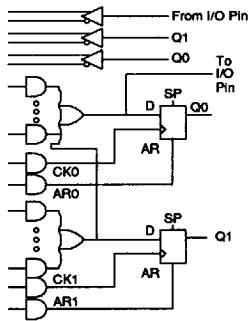

Separate Terms

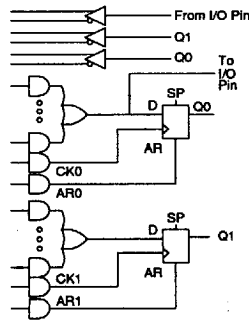

Combined Terms

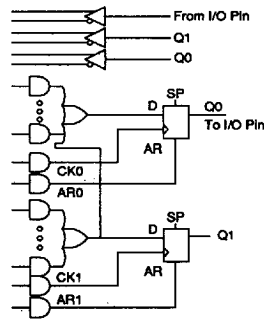

Separate Terms

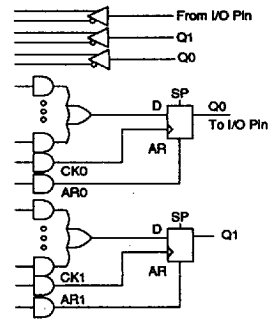

Output Options

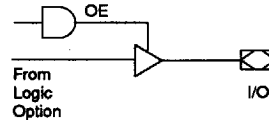
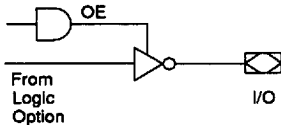

D.C. and A.C. Operating Conditions

		ATV750-20	ATV750/L-25	ATV750/L-30	ATV750/L-35	ATV750/L-40
Operating Temperature (Case)	Com.	0°C - 70°C	0°C - 70°C	0°C - 70°C	0°C - 70°C	0°C - 70°C
	Ind.	-40°C - 85°C	-40°C - 85°C	-40°C - 85°C	-40°C - 85°C	-40°C - 85°C
	Mil.	-55°C - 125°C	-55°C - 125°C	-55°C - 125°C	-55°C - 125°C	-55°C - 125°C
Vcc Power Supply		5 V ± 10%	5 V ± 10%	5 V ± 10%	5 V ± 10%	5 V ± 10%

D.C. Characteristics

Symbol	Parameter	Condition	Min	Typ	Max	Units	
I _{LI}	Input Load Current	V _{IN} = -0.1 V to V _{CC} +1 V			10	μA	
I _{LO}	Output Leakage Current	V _{OUT} = -0.1 V to V _{CC} +0.1 V			10	μA	
I _{CC}	Power Supply Current	V _{CC} = MAX, V _{IN} = GND, Outputs Open	ATV750	Com.		120	mA
				Ind.,Mil.		140	mA
			ATV750L	Com.	1.0	12	mA
				Ind.,Mil.	1.0	15	mA
I _{CC2} (2)	Clocked Power Supply Current	f = 1MHz, V _{CC} = MAX, Outputs Open	ATV750L	Com.		15	mA
				Ind.,Mil.		20	mA
I _{OS} (1)	Output Short Circuit Current	V _{OUT} = 0.5 V			-90	mA	
V _{IL}	Input Low Voltage		-0.6		0.8	V	
V _{IH}	Input High Voltage		2.0		V _{CC} +0.75	V	
V _{OL}	Output Low Voltage	V _{IN} = V _{IH} or V _{IL} , V _{CC} = MIN	I _{OL} = 12 mA Com.,Ind.		0.5	V	
			I _{OL} = 8 mA Mil.		0.5	V	
			I _{OL} = 24 mA, Com.		1.0	V	
V _{OH}	Output High Voltage	V _{IN} = V _{IH} or V _{IL} , V _{CC} = MIN	I _{OH} = -100 μA	V _{CC} -0.3		V	
			I _{OH} = -4.0 mA	2.4		V	

7

Notes: 1. Not more than one output at a time should be shorted. Duration of short circuit test should not exceed 30 sec.
2. Outputs not loaded.

Operating Modes

Mode	24-Pin DIP	1	5	8	11	13	I/Os	V _{CC} (24)
	28-Pin JLCC	2	6	10	13	16	I/Os	V _{CC} (28)
"EPLD"		X ⁽¹⁾	X	X	X	X	I/O	5 V
Program		V _{PP}	X/V _H (2)	X	X/V _H	V _{PP}	DIN	6 V
PGM Verify		V _{PP}	X/V _H	X	X/V _H	V _{IL}	DOUT	5 V
PGM Inhibit		V _{PP}	X/V _H	X	X/V _H	V _{IH}	High Z	5-6 V
Preload #1		X	X	V _H	X	V _{IL}	DIN	5 V
Preload #2		X	X	V _H	X	V _{IH}	DIN	5 V

Notes: 1. X can be V_{IL} or V_{IH}.
2. V_{IH} = 11.0 V to 14.0 V



1074177 0005467 656



A.C. Waveforms ⁽¹⁾

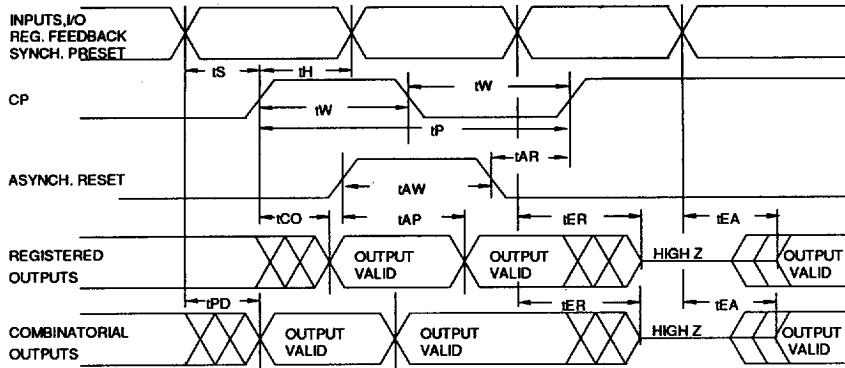

Note: 1. Timing measurement reference is 1.5 V. Input AC driving levels are 0.0 V and 3.0 V, unless otherwise specified.

A.C. Characteristics

Symbol	Parameter	ATV750-30		ATV750-35		ATV750-40		Units
		Min	Max	Min	Max	Min	Max	
t_{PD}	Input or Feedback to Non-Registered Output		30		35		40	ns
t_{EA}	Input to Output Enable		30		35		40	ns
t_{ER}	Input to Output Disable		30		35		40	ns
t_{CO}	Clock to Output	5	25	10	30	10	35	ns
t_{CF}	Clock to Feedback	5	10	10	12	10	15	ns
t_S	Input Setup Time	15		18		20		ns
t_H	Hold Time	5		10		15		ns
t_P	Clock Period	25		30		35		ns
t_W	Clock Width	12		15		17		ns
F_{MAX}	Maximum Frequency		40		33		28	MHz
t_{AW}	Asynchronous Reset Width	30		35		40		ns
t_{AR}	Asynchronous Reset Recovery Time	30		35		40		ns
t_{AP}	Asynchronous Reset to Registered Output Reset		30		35		40	ns
t_{SP}	Setup Time, Synchronous Preset	15		18		20		ns

A.C. Characteristics

Symbol	Parameter	ATV750-20		ATV750/L-25		ATV750L-30		Units
		Min	Max	Min	Max	Min	Max	
t _{PD}	Input or Feedback to Non-Registered Output	20		25		30		ns
t _{EA}	Input to Output Enable	20		25		30		ns
t _{ER}	Input to Output Disable	20		25		30		ns
t _{CO}	Clock to Output	20		22		5	25	ns
t _{CF}	Clock to Feedback	5	10	5	10	5	10	ns
t _S	Input Setup Time	10		12		15		ns
t _{SF}	Feedback Setup Time	5		7		15		ns
t _H	Hold Time	5		5		5		ns
t _P	Clock Period	18		22		25		ns
t _W	Clock Width	8		10		12		ns
F _{MAX}	Maximum Frequency	55		45		40		MHz
t _{AW}	Asynchronous Reset Width	15		20		30		ns
t _{AR}	Asynchronous Reset Recovery Time	15		20		30		ns
t _{AP}	Asynchronous Reset to Registered Output Reset	20		25		30		ns
t _{SP}	Setup Time, Synchronous Preset	12		15		15		ns

7

Input Test Waveforms and Measurement Levels

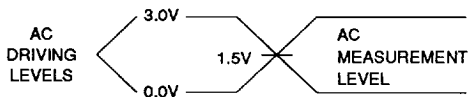

t_R, t_F < 5 ns (10% to 90%)

Output Test Load

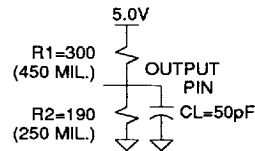

1074177 0005469 429



Functional Logic Diagram ATV750, Upper Half

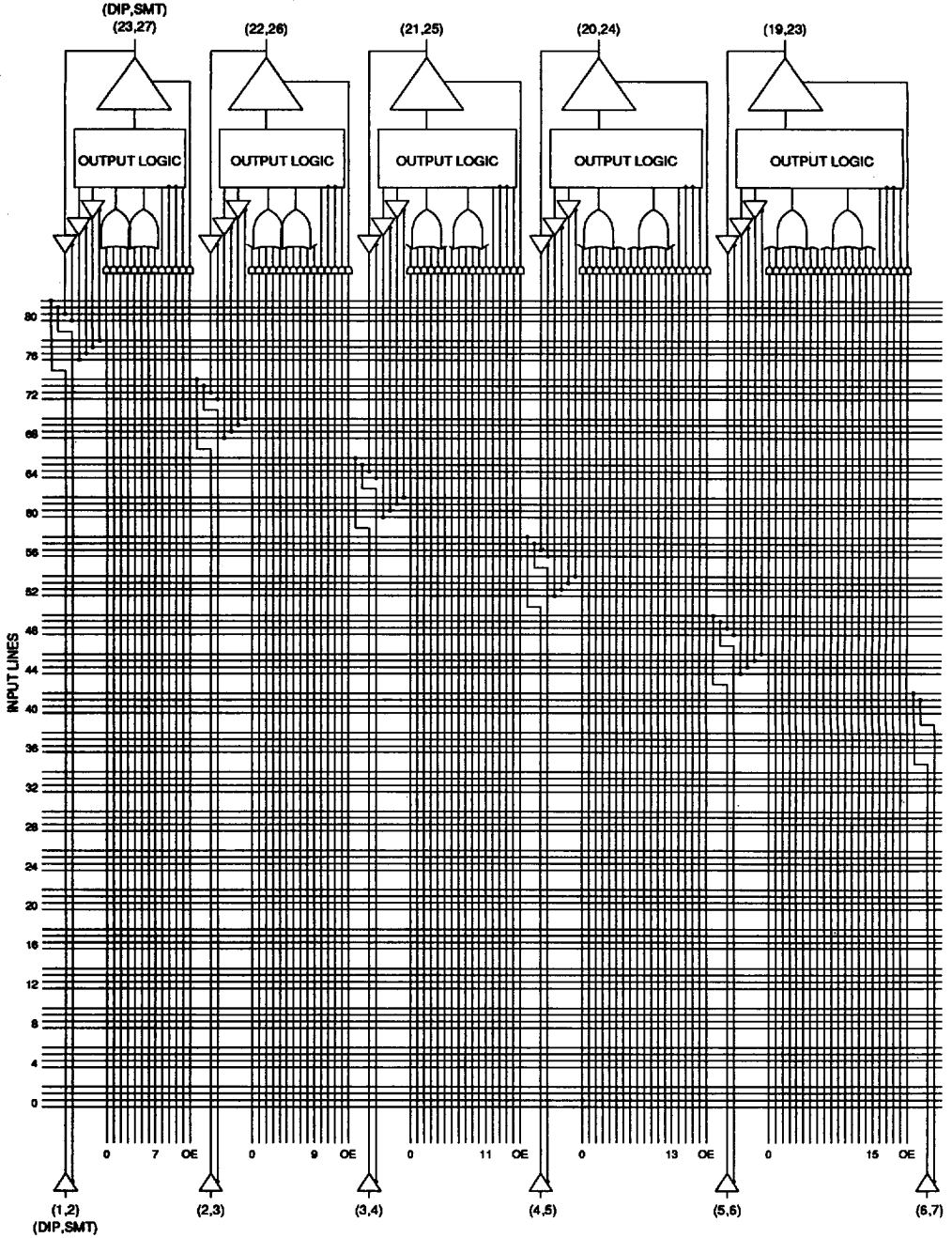

7-64

ATV750/L

1074177 0005470 140

Functional Logic Diagram ATV750, Lower Half

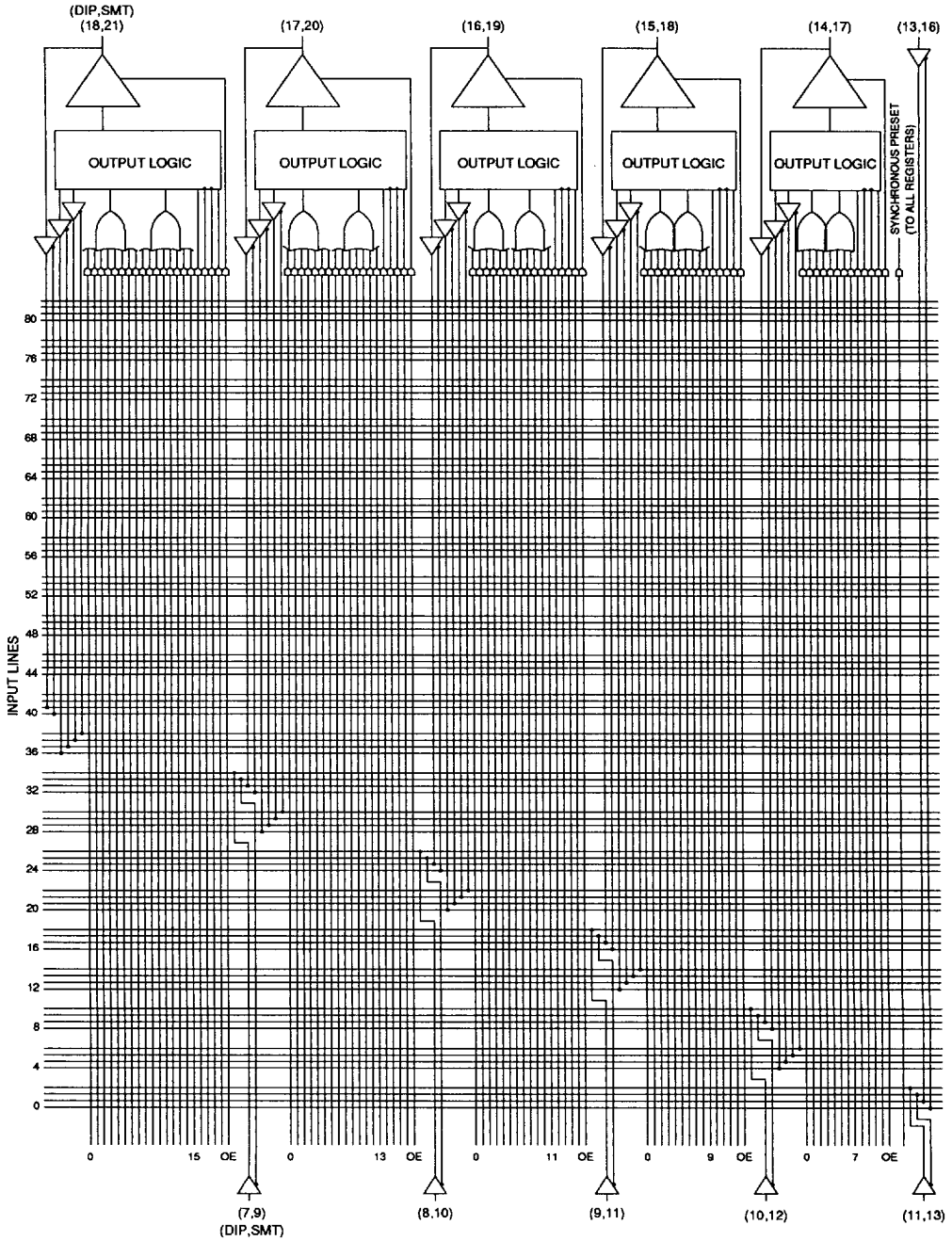

7



1074177 0005471 087

Preload of Registered Outputs

The ATV750's registers are provided with circuitry to allow loading of each register asynchronously with either a high or a low. This feature will simplify testing since any state can be forced into the registers to control test sequencing. A V_{IH} level on the I/O pin will force the register high; a V_{IL} will force it low,

independent of the polarity bit (S0) setting. The PRELOAD state is entered by placing an 11 V to 14 V signal on pin 8 on DIPs, and pin 10 on SMPs. When the clock term is pulsed high, the data on the I/O pin is placed into the register chosen by the Select Pin.

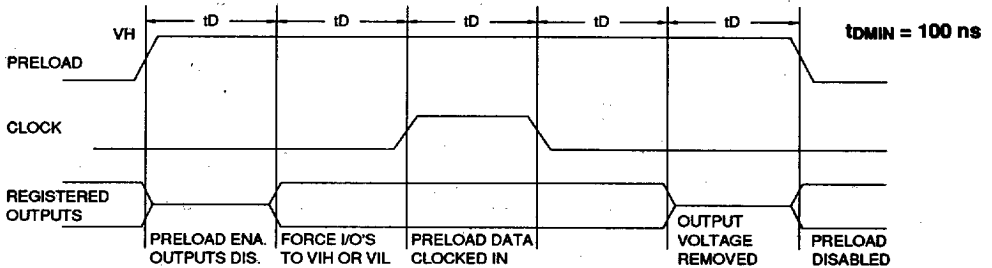

Level forced on registered output pin during PRELOAD cycle	Select Pin State	Register #1 state after cycle	Register #2 State after cycle
V_{IH}	Low	High	X
V_{IL}	Low	Low	X
V_{IH}	High	X	High
V_{IL}	High	X	Low

Power Up Reset

The registers in the ATV750/L are designed to reset during power up. At a point delayed slightly from V_{CC} crossing 3.8 V, all registers will be reset to the low state. The output state will depend on the polarity of the output buffer.

This feature is critical for state machine initialization. However, due to the asynchronous nature of reset and the uncertainty of how V_{CC} actually rises in the system, the following conditions are required:

- 1) The V_{CC} rise must be monotonic,
- 2) After reset occurs, all input and feedback setup times must be met before driving the clock term high, and
- 3) The signals from which the clock is derived must remain stable during t_{PR} .

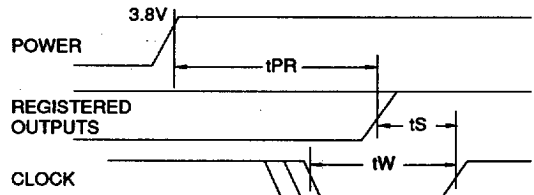

Parameter	Description	Min	Typ	Max	Units
t_{PR}	Power-Up Reset Time		600	1000	ns

Pin Capacitance ($f = 1 \text{ MHz}$, $T = 25^\circ\text{C}$) ⁽¹⁾

	Typ	Max	Units	Conditions
C_{IN}	5	8	pF	$V_{IN} = 0 \text{ V}$
C_{OUT}	6	8	pF	$V_{OUT} = 0 \text{ V}$

Note: 1. Typical values for nominal supply voltage. This parameter is only sampled and is not 100% tested.

Using The ATV750's Many Advanced Features

The ATV750's flexibility puts more usable gates in 24 pins than other EPLDs. The ATV750/L starts with an architecture similar to the popular AT22V10, and adds several features:

- **Asynchronous Clocks** - Each of the Flip-Flops in the ATV750/L has a dedicated product term driving the clock. The user is no longer constrained to using one clock for all the registers. Buried state machines, counters, and registers can all coexist in one device, while running on separate clocks. The ATV750/L clock period matches that of similar synchronous devices.
- **A Full Bank of 10 More Registers** - The ATV750/L provides two Flip-Flops for each Output Macrocell - a total of 20. Each register has its own clock and

reset product terms, as well as its own SUM term.

- **Independent I/O Pin and Feedback Paths** - Each I/O pin on the ATV750/L has a dedicated input path. Each of the 20 registers has individual feedback terms into the array. This feature, combined with individual product terms for each I/O's Output Enable, facilitates designs using bi-directional I/O buses.
- **Combinable Sum Terms** - Each Output Macrocell's two SUM terms can be combined in an OR gate before the Output or the Register. This provides up to 16 product terms per Output or Flip-Flop. This architecture increases the number of usable gates available.

Programming Software Support

Software which is capable of transforming Boolean equations, state machine descriptions and truth tables into JEDEC files for the ATV750/L is available from the following sources:

- | | |
|----------------------------|----------------------------|
| Data I/O / FutureNet Corp. | - ABEL 2.1, 3.0, and above |
| Logical Devices | - CUPL 2.15B, and above |

Synchronous Preset and Asynchronous Reset

One synchronous preset line is provided for all 20 registers in the ATV750/L. The appropriate input signals to cause the internal clocks to go to a high state must be received during a synchronous preset. Appropriate setup and hold times must be met, as shown in the switching waveform diagram.

An individual asynchronous reset line is provided for each of the 20 Flip-Flops. Both Master and Slave halves of the Flip-Flops are reset when the input signals received combine so as to force the internal resets high.

Security Fuse Usage

A single fuse is provided to prevent unauthorized copying of the ATV750/L fuse patterns. Once programmed, the output buffers will remain in a high impedance state during verify.

The security fuse should be programmed last, as its effect is immediate.

Erasure Characteristics

The entire memory array of an ATV750/L is erased after exposure to ultraviolet light at a wavelength of 2537 Å. Complete erasure is assured after a minimum of 20 minutes exposure using 12,000 $\mu\text{W}/\text{cm}^2$ intensity lamps spaced one inch away from the chip. Minimum erase time for lamps at other intensity

ratings can be calculated from the minimum integrated erasure dose of 15 $\text{W}\cdot\text{sec}/\text{cm}^2$. To prevent unintentional erasure, an opaque label is recommended to cover the clear window on any UV erasable EPLD which will be subjected to continuous fluorescent indoor lighting or sunlight.

Atmel CMOS EPLDs

Atmel's Erasable Programmable Logic Devices utilize an advanced 1.5-micron CMOS EPROM technology. This technology's state of the art features are the optimum combination for EPLDs:

- CMOS technology provides high speed, low power, and high noise immunity.
- EPROM technology is the most cost effective method for producing EPLDs - surpassing bipolar fusible link technol-

ogy in low cost, while providing the necessary reprogrammability.

- EPROM reprogrammability, which is 100% tested before shipment, provides inherently better programmability and reliability than one-time fusible PLDs.
- Atmel's EPROM process has proven extremely reliable in the volume production of a full line of advanced EPROM memory products, from 64K to one-megabit devices.



V750 ICC vs FREQUENCY

TA = 25C, VCC = 5V

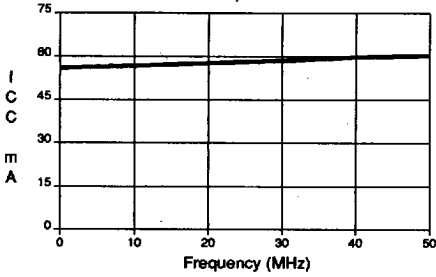

V750L ICC vs FREQUENCY

TA = 25C, VCC = 5V

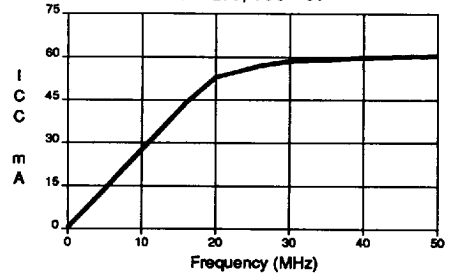

NORMALIZED ICC vs. VCC

TA = 25C, f = 30 MHz

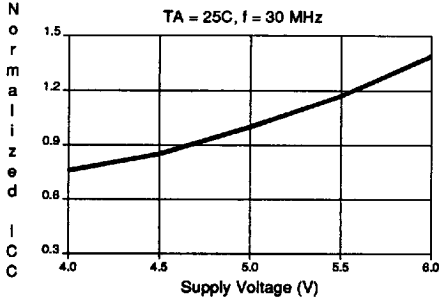

NORMALIZED ICC vs. AMBIENT TEMP.

f = 30 MHz, VCC = 5V

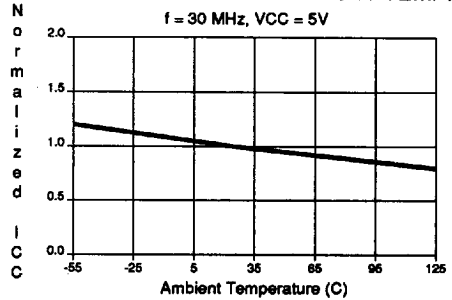

Ordering Information

tpD (ns)	tcO (ns)	fMAX (MHz)	Ordering Code	Package	Operation Range
20	18	55	ATV750-20DC ATV750-20FC ATV750-20GC ATV750-20JC ATV750-20KC ATV750-20LC ATV750-20NC ATV750-20PC ATV750-20SC ATV750-20YC	24DW3 24C 24D3 28J 28KW 28LW 28L 24P3 24S 24CW	Commercial (0°C to 70°C)
			ATV750-20DI ATV750-20FI ATV750-20GI ATV750-20JI ATV750-20KI ATV750-20LI ATV750-20NI ATV750-20PI ATV750-20SI ATV750-20YI	24DW3 24C 24D3 28J 28KW 28LW 28L 24P3 24S 24CW	Industrial (-40°C to 85°C)
			ATV750-20DM ATV750-20FM ATV750-20GM ATV750-20KM ATV750-20LM ATV750-20NM ATV750-20YM	24DW3 24C 28D3 28KW 28LW 28L 24CW	Military (-55°C to 125°C)
			ATV750-20DM/883 ATV750-20FM/883 ATV750-20GM/883 ATV750-20KM/883 ATV750-20LM/883 ATV750-20NM/883 ATV750-20YM/883	24DW3 24C 24D3 28KW 28LW 28L 24CW	Military/883C (-55°C to 125°C) Class B, Fully Compliant
25	22	45	ATV750-25DC ATV750-25FC ATV750-25GC ATV750-25JC ATV750-25KC ATV750-25LC ATV750-25NC ATV750-25PC ATV750-25SC ATV750-25YC	24DW3 24C 24D3 28J 28KW 28LW 28L 24P3 24S 24CW	Commercial (0°C to 70°C)

7



1074177 0005475 722



Ordering Information

tpd (ns)	tco (ns)	fMAX (MHz)	Ordering Code	Package	Operation Range
25	22	45	ATV750-25DI ATV750-25FI ATV750-25GI ATV750-25JI ATV750-25KI ATV750-25LI ATV750-25NI ATV750-25PI ATV750-25SI ATV750-25YI	24DW3 24C 24D3 28J 28KW 28LW 28L 24P3 24S 24CW	Industrial (-40°C to 85°C)
			ATV750-25DM ATV750-25FM ATV750-25GM ATV750-25KM ATV750-25LM ATV750-25NM ATV750-25YM	24DW3 24C 24D3 28KW 28LW 28L 24CW	Military (-55°C to 125°C)
			ATV750-25DM/883 ATV750-25FM/883 ATV750-25GM/883 ATV750-25KM/883 ATV750-25LM/883 ATV750-25NM/883 ATV750-25YM/883	24DW3 24C 24D3 28KW 28LW 28L 24CW	Military/883C (-55°C to 125°C) Class B, Fully Compliant
30	25	40	ATV750-30DC ATV750-30FC ATV750-30GC ATV750-30JC ATV750-30KC ATV750-30LC ATV750-30NC ATV750-30PC ATV750-30SC ATV750-30YC	24DW3 24C 24D3 28J 28KW 28LW 28L 24P3 24S 24CW	Commercial (0°C to 70°C)
			ATV750-30DI ATV750-30FI ATV750-30GI ATV750-30JI ATV750-30KI ATV750-30LI ATV750-30NI ATV750-30PI ATV750-30SI ATV750-30YI	24DW3 24C 24D3 28J 28KW 28LW 28L 24P3 24S 24CW	Industrial (-40°C to 85°C)

Ordering Information

tpd (ns)	tco (ns)	fMAX (MHz)	Ordering Code	Package	Operation Range
30	25	40	ATV750-30DM ATV750-30FM ATV750-30GM ATV750-30KM ATV750-30LM ATV750-30NM ATV750-30YM	24DW3 24C 24D3 28KW 28LW 28L 24CW	Military (-55°C to 125°C)
			ATV750-30DM/883 ATV750-30FM/883 ATV750-30GM/883 ATV750-30KM/883 ATV750-30LM/883 ATV750-30NM/883 ATV750-30YM/883	24DW3 24C 24D3 28KW 28LW 28L 24CW	Military/883C (-55°C to 125°C) Class B, Fully Compliant
35	30	33	ATV750-35DC ATV750-35FC ATV750-35GC ATV750-35JC ATV750-35KC ATV750-35LC ATV750-35NC ATV750-35PC ATV750-35SC ATV750-35YC	24DW3 24C 24D3 28J 28KW 28LW 28L 24P3 24S 24CW	Commercial (0°C to 70°C)
			ATV750-35DI ATV750-35FI ATV750-35GI ATV750-35JI ATV750-35KI ATV750-35LI ATV750-35NI ATV750-35PI ATV750-35SI ATV750-35YI	24DW3 24C 24D3 28J 28KW 28LW 28L 24P3 24S 24CW	Industrial (-40°C to 85°C)
			ATV750-35DM ATV750-35FM ATV750-35GM ATV750-35KM ATV750-35LM ATV750-35NM ATV750-35YM	24DW3 24C 24D3 28KW 28LW 28L 24CW	Military (-55°C to 125°C)
			ATV750-35DM/883 ATV750-35FM/883 ATV750-35GM/883 ATV750-35KM/883 ATV750-35LM/883 ATV750-35NM/883 ATV750-35YM/883	24DW3 24C 24D3 28KW 28LW 28L 24CW	Military/883C (-55°C to 125°C) Class B, Fully Compliant

7



1074177 0005477 5T5



Ordering Information

tpd (ns)	tco (ns)	fMAX (MHz)	Ordering Code	Package	Operation Range
40	35	28	ATV750-40DI	24DW3	Industrial (-40°C to 85°C)
			ATV750-40FI	24C	
			ATV750-40GI	24D3	
			ATV750-40JI	28J	
			ATV750-40KI	28KW	
			ATV750-40LI	28LW	
			ATV750-40NI	28L	
			ATV750-40PI	24P3	
			ATV750-40SI	24S	
ATV750-40YI	24CW				
			ATV750-40DM	24DW3	Military (-55°C to 125°C)
			ATV750-40FM	24C	
			ATV750-40GM	24D3	
			ATV750-40KM	28KW	
			ATV750-40LM	28LW	
			ATV750-40NM	28L	
ATV750-40YM	24CW				
			ATV750-40DM/883	24DW3	Military/883C (-55°C to 125°C) Class B, Fully Compliant
			ATV750-40FM/883	24C	
			ATV750-40GM/883	24D3	
			ATV750-40KM/883	28KW	
			ATV750-40LM/883	28LW	
			ATV750-40NM/883	28L	
ATV750-40YM/883	24CW				
20	18	55	5962-88726 04 LX 5962-88726 04 3X	24DW3 28LW	Military/883C (-55°C to 125°C) Class B, Fully Compliant
25	22	45	5962-88726 03 LX 5962-88726 03 3X	24DW3 28LW	Military/883C (-55°C to 125°C) Class B, Fully Compliant
35	30	33	5962-88726 02 LX 5962-88726 02 3X	24DW3 28LW	Military/883C (-55°C to 125°C) Class B, Fully Compliant
40	35	28	5962-88726 01 LX 5962-88726 01 3X	24DW3 28LW	Military/883C (-55°C to 125°C) Class B, Fully Compliant

Package Type	
24DW3	24 Lead, 0.300" Wide, Windowed, Ceramic Dual Inline Package (Cerdip)
24C	24 Lead, Non-Windowed, Ceramic Flat Package (Cerpack)
24D3	24 Lead, 0.300" Wide, Non-Windowed (OTP) Ceramic Dual Inline Package (Cerdip)
28J	28 Lead, Plastic J-Leaded Chip Carrier OTP (PLCC)
28KW	28 Lead, Windowed, Ceramic J-Leaded Chip Carrier (JLCC)
28LW	28 Pad, Windowed, Ceramic Leadless Chip Carrier (LCC)
28L	28 Pad, Non-Windowed, Ceramic Leadless Chip Carrier OTP (LCC)
24P3	24 Lead, 0.300" Wide, Plastic Dual Inline Package OTP (PDIP)
24S	24 Lead, 0.300" Wide, Plastic Gull Wing Small Outline OTP (SOIC)
24CW	24 Lead, Windowed, Ceramic Flat Package (Cerpack)



1074177 0005479 378



Ordering Information

tpd (ns)	tco (ns)	fMAX (MHz)	Ordering Code	Package	Operation Range	
25	22	45	ATV750L-25DC	24DW3	Commercial (0°C to 70°C)	
			ATV750L-25FC	24C		
			ATV750L-25GC	24D3		
			ATV750L-25JC	28J		
			ATV750L-25KC	28KW		
			ATV750L-25LC	28LW		
			ATV750L-25NC	28L		
			ATV750L-25PC	24P3		
			ATV750L-25SC	24S		
			ATV750L-25YC	24P3		
			ATV750L-25DI	24DW3		Industrial (-40°C to 85°C)
			ATV750L-25FI	24C		
			ATV750L-25GI	24D3		
			ATV750L-25JI	28J		
			ATV750L-25KI	28KW		
			ATV750L-25LI	28LW		
ATV750L-25NI	28L					
ATV750L-25PI	24P3					
ATV750L-25SI	24S					
ATV750L-25YI	24CW					
ATV750L-25DM	24DW3	Military (-55°C to 125°C)				
ATV750L-25FM	24C					
ATV750L-25GM	24D3					
ATV750L-25KM	28KW					
ATV750L-25LM	28LW					
ATV750L-25NM	28L					
ATV750L-25YM	24CW					
ATV750L-25DM/883	24DW3	Military/883C (-55°C to 125°C) Class B, Fully Compliant				
ATV750L-25FM/883	24C					
ATV750L-25GM/883	24D3					
ATV750L-25KM/883	28KW					
ATV750L-25LM/883	28LW					
ATV750L-25NM/883	28L					
ATV750L-25YM/883	24CW					
30	25	40	ATV750L-30DC	24DW3	Commercial (0°C to 70°C)	
			ATV750L-30FC	24C		
			ATV750L-30GC	24D3		
			ATV750L-30JC	28J		
			ATV750L-30KC	28KW		
			ATV750L-30LC	28LW		
			ATV750L-30NC	28L		
			ATV750L-30PC	24P3		
			ATV750L-30SC	24S		
			ATV750L-30YC	24P3		

Ordering Information

tpD (ns)	tCO (ns)	fMAX (MHz)	Ordering Code	Package	Operation Range
30	25	40	ATV750L-30DI	24DW3	Industrial (-40°C to 85°C)
			ATV750L-30FI	24C	
			ATV750L-30GI	24D3	
			ATV750L-30JI	28J	
			ATV750L-30KI	28KW	
			ATV750L-30LI	28LW	
			ATV750L-30NI	28L	
			ATV750L-30PI	24P3	
			ATV750L-30SI	24S	
ATV750L-30YI	24CW				
			ATV750L-30DM	24DW3	Military (-55°C to 125°C)
			ATV750L-30FM	24C	
			ATV750L-30GM	24D3	
			ATV750L-30KM	28KW	
			ATV750L-30LM	28LW	
			ATV750L-30NM	28L	
			ATV750L-30DM/883	24DW3	Military/883C (-55°C to 125°C) Class B, Fully Compliant
			ATV750L-30FM/883	24C	
			ATV750L-30GM/883	24D3	
			ATV750L-30KM/883	28KW	
			ATV750L-30LM/883	28LW	
			ATV750L-30NM/883	28L	
25	22	45	5962-88726 07 LX	24DW3	Military/883C (-55°C to 125°C) Class B, Fully Compliant
			5962-88726 07 3X	28LW	
30	25	40	5962-88726 07 LX	24DW3	Military/883C (-55°C to 125°C) Class B, Fully Compliant
			5962-88726 07 3X	28LW	

7

Package Type	
24DW3	24 Lead, 0.300" Wide, Windowed, Ceramic Dual Inline Package (Cerdip)
24C	24 Lead, Non-Windowed, Ceramic Flat Package (Cerpack)
24D3	24 Lead, 0.300" Wide, Non-Windowed (OTP) Ceramic Dual Inline Package (Cerdip)
28J	28 Lead, Plastic J-Leaded Chip Carrier OTP (PLCC)
28KW	28 Lead, Windowed, Ceramic J-Leaded Chip Carrier (JLCC)
28LW	28 Pad, Windowed, Ceramic Leadless Chip Carrier (LCC)
28L	28 Pad, Non-Windowed, Ceramic Leadless Chip Carrier OTP (LCC)
24P3	24 Lead, 0.300" Wide, Plastic Dual Inline Package OTP (PDIP)
24S	24 Lead, 0.300" Wide, Plastic Gull Wing Small Outline OTP (SOIC)
24CW	24 Lead, Windowed, Ceramic Flat Package (Cerpack)



1074177 0005481 T26