

TOSHIBA FIELD EFFECT TRANSISTOR SILICON P CHANNEL MOS TYPE (L²-π-MOSV)

2SJ412

DC-DC CONVERTER, RELAY DRIVE AND MOTOR DRIVE APPLICATIONS

- 4 V Gate Drive
- Low Drain-Source ON Resistance : $R_{DS(ON)} = 0.15 \Omega$ (Typ.)
- High Forward Transfer Admittance : $|Y_{fs}| = 7.7 S$ (Typ.)
- Low Leakage Current : $I_{DSS} = -100 \mu A$ (Max.) ($V_{DS} = -100 V$)
- Enhancement-Mode : $V_{th} = -0.8 \sim -2.0 V$
($V_{DS} = -10 V, I_D = -1 mA$)

MAXIMUM RATINGS (Ta = 25°C)

CHARACTERISTIC		SYMBOL	RATING	UNIT
Drain-Source Voltage		V_{DSS}	-100	V
Drain-Gate Voltage ($R_{GS} = 20 k\Omega$)		V_{DGR}	-100	V
Gate-Source Voltage		V_{GSS}	± 20	V
Drain Current	DC (Note 1)	I_D	-16	A
	Pulse (Note 1)	I_{DP}	-64	A
Drain Power Dissipation ($T_c = 25^\circ C$)		P_D	60	W
Single Pulse Avalanche Energy (Note 2)		E_{AS}	292	mJ
Avalanche Current		I_{AR}	-16	A
Repetitive Avalanche Energy (Note 3)		E_{AR}	6	mJ
Channel Temperature		T_{ch}	150	°C
Storage Temperature Range		T_{stg}	-55~150	°C

THERMAL CHARACTERISTICS

CHARACTERISTIC	SYMBOL	MAX.	UNIT
Thermal Resistance, Channel to Case	$R_{th(ch-c)}$	2.08	°C/W
Thermal Resistance, Channel to Ambient	$R_{th(ch-a)}$	83.3	°C/W

- (Note 1) : Please use devices on condition that the channel temperature is below 150°C.
 (Note 2) : $V_{DD} = -25 V, T_{ch} = 25^\circ C$ (initial), $L = 1.84 mH, R_G = 25 \Omega, I_{AR} = -16 A$
 (Note 3) : Repetitive rating ; Pulse Width Limited by maximum junction temperature.

This transistor is an electrostatic sensitive device. Please handle with caution.

Unit in mm

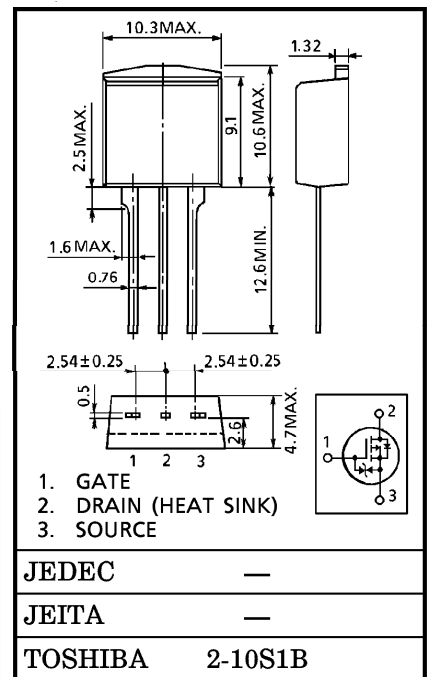

Weight : 1.5 g (Typ.)

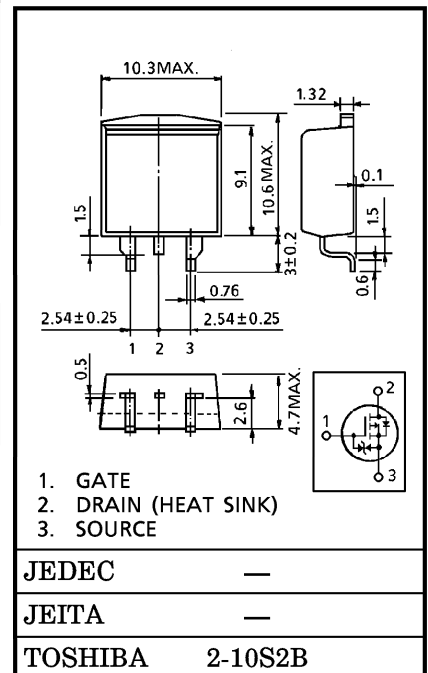

Weight : 1.5 g (Typ.)

ELECTRICAL CHARACTERISTICS (Ta = 25°C)

CHARACTERISTIC		SYMBOL	TEST CONDITION	MIN.	TYP.	MAX.	UNIT
Gate Leakage Current		IGSS	VGS = ±16 V, VDS = 0 V	—	—	±10	μA
Drain Cut-off Current		IDSS	VDS = -100 V, VGS = 0 V	—	—	-100	μA
Drain-Source Breakdown Voltage		V(BR)DSS	ID = -10 mA, VGS = 0 V	-100	—	—	V
Gate Threshold Voltage		Vth	VDS = -10 V, ID = -1 mA	-0.8	—	-2.0	V
Drain-Source ON Resistance		RDS(ON)	VGS = -4 V, ID = -6 A	—	0.25	0.32	Ω
			VGS = -10 V, ID = -6 A	—	0.15	0.21	
Forward Transfer Admittance		Yfs	VDS = -10 V, ID = -6 A	4.5	7.7	—	S
Input Capacitance		Ciss	VDS = -10 V, VGS = 0 V, f = 1MHz	—	1100	—	pF
Reverse Transfer Capacitance		Crss		—	210	—	
Output Capacitance		Coss		—	440	—	
Switching Time	Rise Time	tr		—	18	—	ns
	Turn-on Time	ton		—	30	—	
	Fall Time	tf		—	18	—	
	Turn-off Time	toff		Duty ≤ 1%, tw = 10 μs	—	65	
Total Gate Charge (Gate-Source Plus Gate-Drain)		Qg	VDD = -80 V, VGS = -10 V, ID = -16 A	—	48	—	nC
Gate-Source Charge		Qgs		—	29	—	
Gate-Drain ("Miller") Charge		Qgd		—	19	—	

SOURCE-DRAIN RATINGS AND CHARACTERISTICS (Ta = 25°C)

CHARACTERISTIC	SYMBOL	TEST CONDITION	MIN.	TYP.	MAX.	UNIT
Continuous Drain Reverse Current (Note 1)	IDR	—	—	—	-16	A
Pulse Drain Reverse Current (Note 1)	IDRP	—	—	—	-64	A
Forward Voltage (Diode)	VDSF	IDR = -16 A, VGS = 0 V	—	—	1.7	V
Reverse Recovery Time	trr	IDR = -16 A, VGS = 0 V	—	160	—	ns
Reverse Recovery Charge	Qrr	dIDR / dt = 50 A / μs	—	0.5	—	μC

MARKING

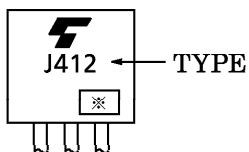

※ Lot Number

□ □ — Month (Starting from Alphabet A)

— Year (Last Number of the Christian Era)

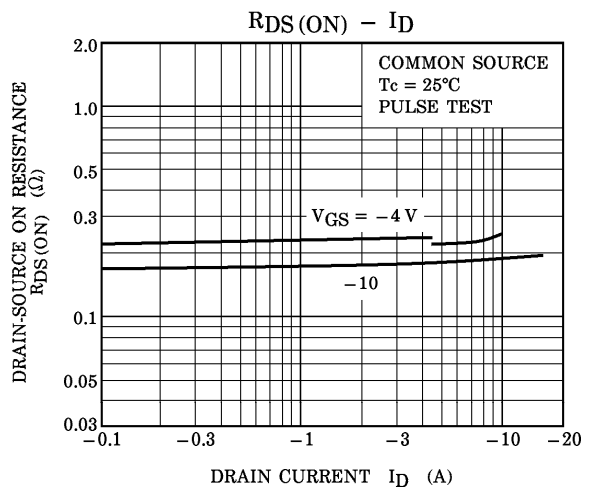
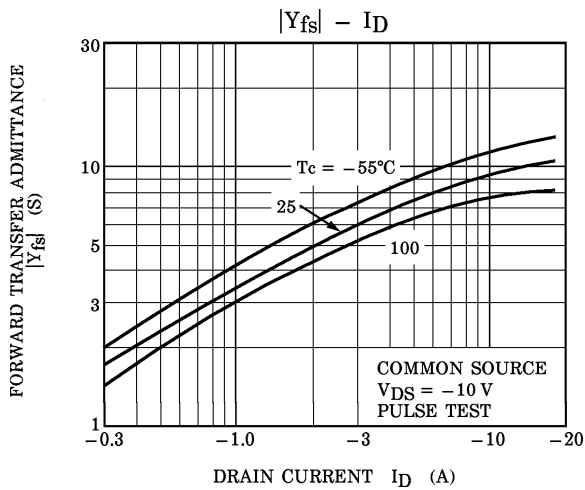
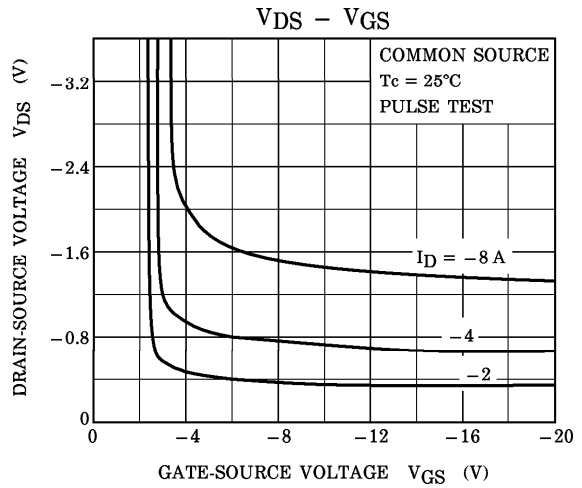
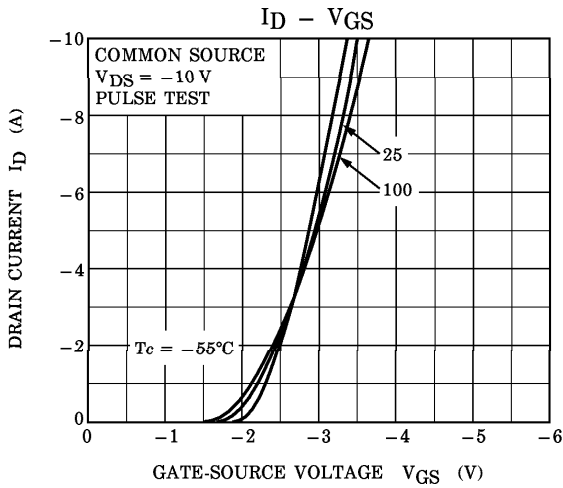
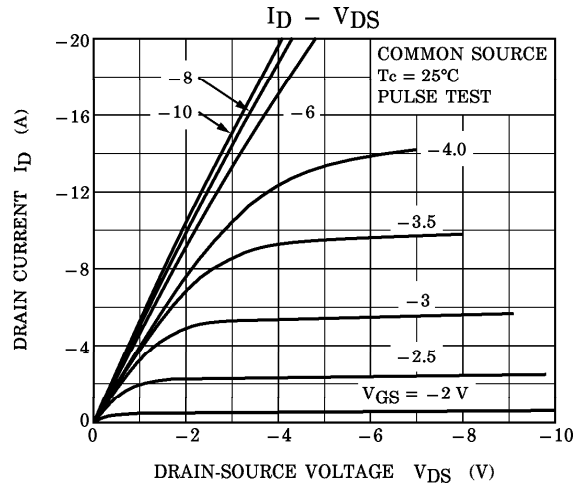
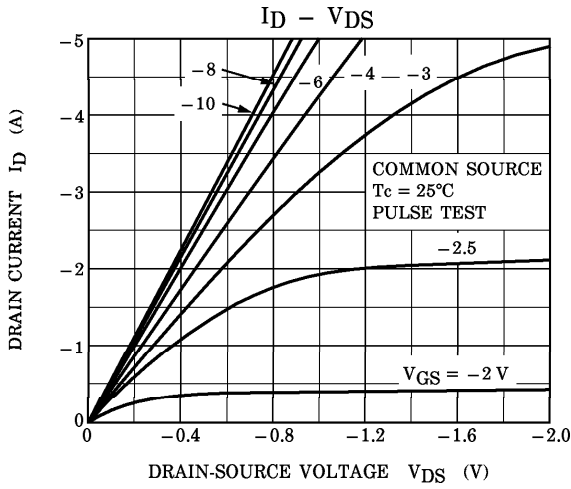

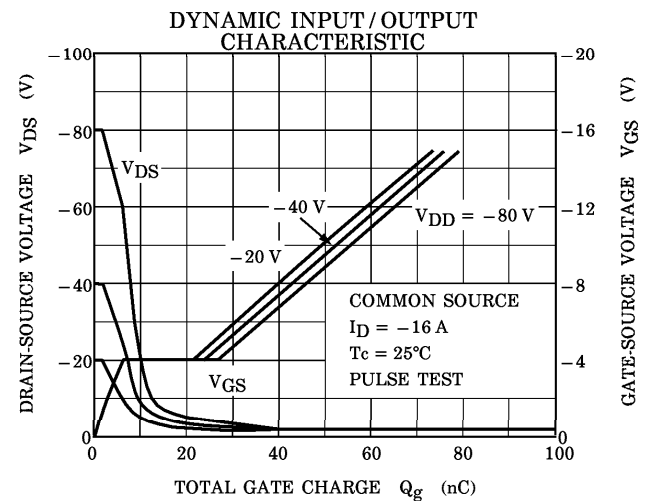
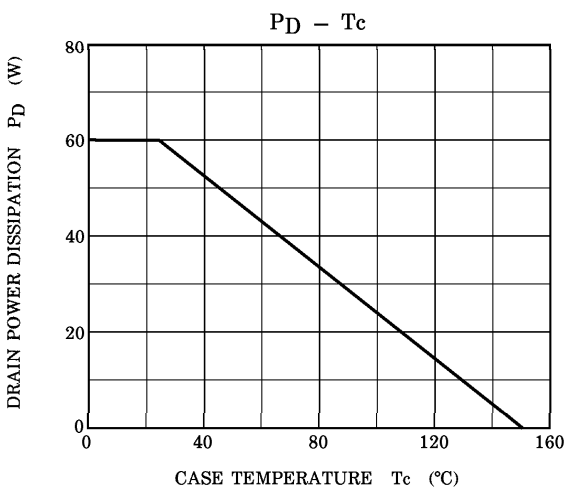
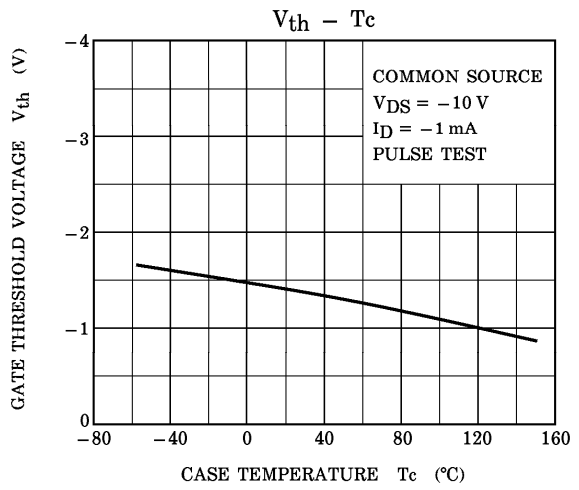
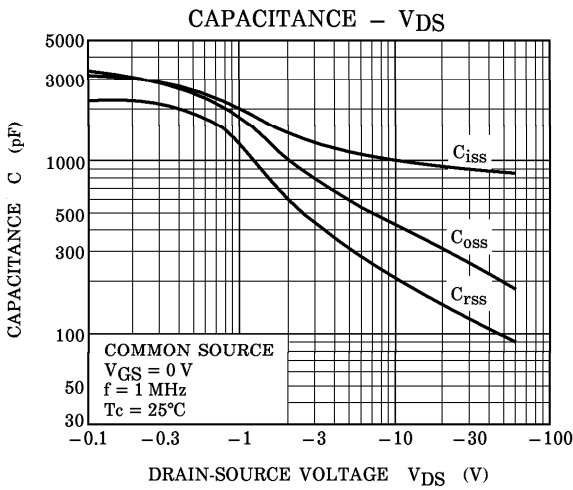
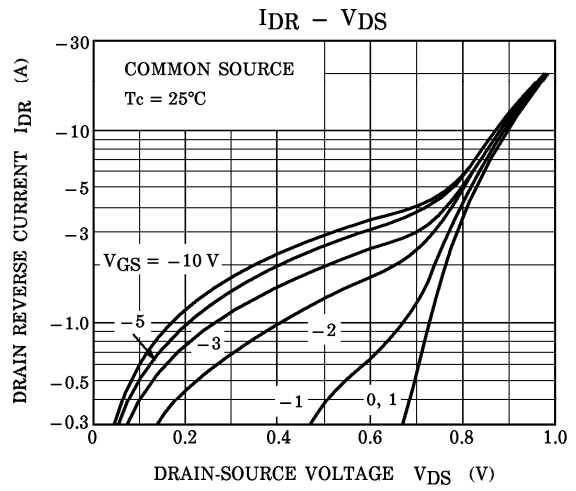
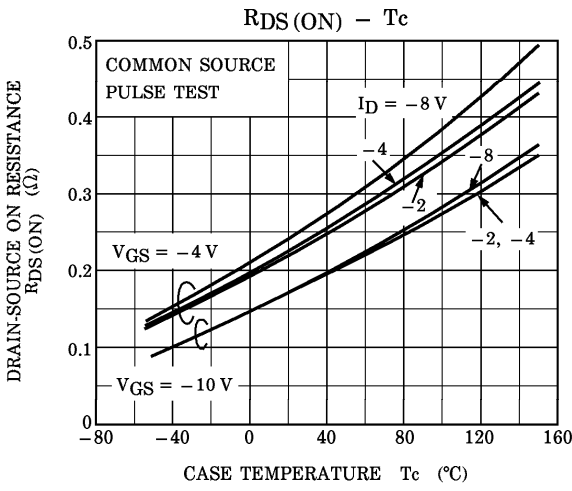

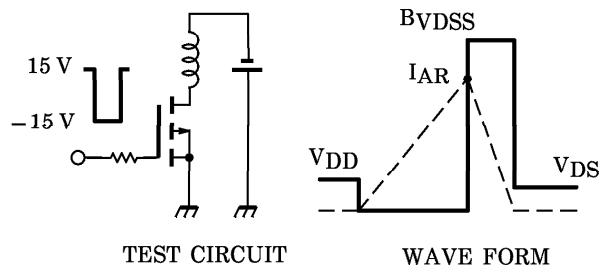
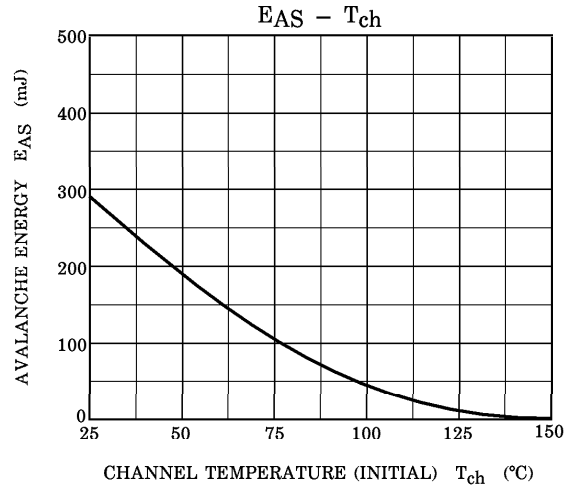
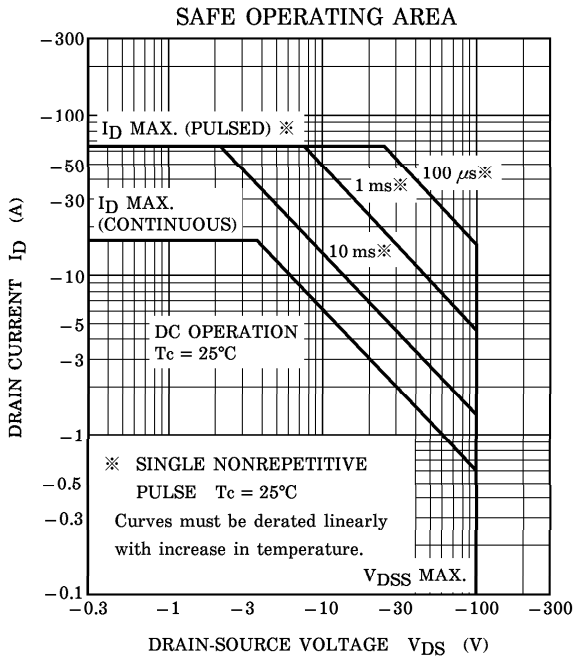
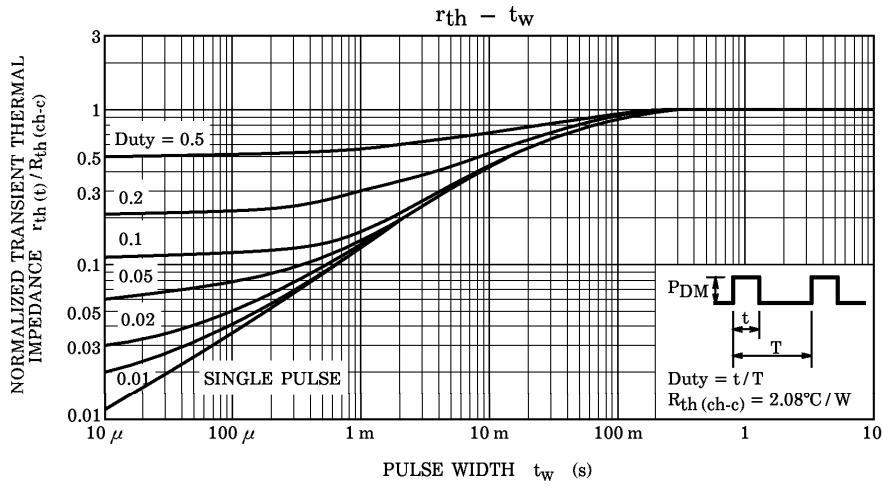

$R_G = 25\Omega$
 $V_{DD} = -25\text{ V}, L = 1.84\text{ mH}$

$$E_{AS} = \frac{1}{2} \cdot L \cdot I^2 \cdot \left(\frac{BV_{DS}}{BV_{DS} - V_{DD}} \right)$$

RESTRICTIONS ON PRODUCT USE

000707EAA

- TOSHIBA is continually working to improve the quality and reliability of its products. Nevertheless, semiconductor devices in general can malfunction or fail due to their inherent electrical sensitivity and vulnerability to physical stress. It is the responsibility of the buyer, when utilizing TOSHIBA products, to comply with the standards of safety in making a safe design for the entire system, and to avoid situations in which a malfunction or failure of such TOSHIBA products could cause loss of human life, bodily injury or damage to property. In developing your designs, please ensure that TOSHIBA products are used within specified operating ranges as set forth in the most recent TOSHIBA products specifications. Also, please keep in mind the precautions and conditions set forth in the "Handling Guide for Semiconductor Devices," or "TOSHIBA Semiconductor Reliability Handbook" etc..
- The TOSHIBA products listed in this document are intended for usage in general electronics applications (computer, personal equipment, office equipment, measuring equipment, industrial robotics, domestic appliances, etc.). These TOSHIBA products are neither intended nor warranted for usage in equipment that requires extraordinarily high quality and/or reliability or a malfunction or failure of which may cause loss of human life or bodily injury ("Unintended Usage"). Unintended Usage include atomic energy control instruments, airplane or spaceship instruments, transportation instruments, traffic signal instruments, combustion control instruments, medical instruments, all types of safety devices, etc.. Unintended Usage of TOSHIBA products listed in this document shall be made at the customer's own risk.
- The information contained herein is presented only as a guide for the applications of our products. No responsibility is assumed by TOSHIBA CORPORATION for any infringements of intellectual property or other rights of the third parties which may result from its use. No license is granted by implication or otherwise under any intellectual property or other rights of TOSHIBA CORPORATION or others.
- The information contained herein is subject to change without notice.