

## DC - 14 GHz Power Amplifier

## TGA8349-SCC

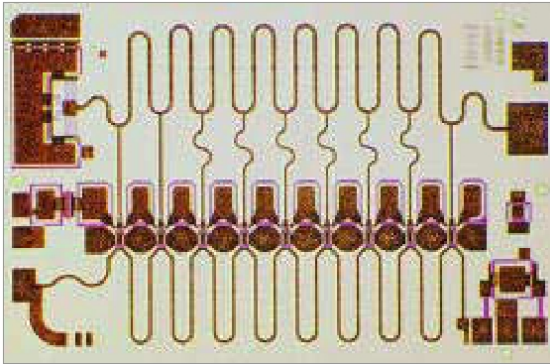

### Key Features and Performance

- DC to 14 GHz Frequency Range
- 1.2:1 Input SWR, 1.3:1 Output SWR
- 11dB Small Signal Gain
- 16dBm Output Power at 1dB Gain Compression at Midband
- 3.1dB Noise Figure at Midband
- 3,4290 x 2,2860 x 0,101 mm (0.135 x 0.090 x 0.004 in.)

### Description

The TriQuint TGA8349-SCC is a GaAs monolithic low noise distributed amplifier designed for use as a multi-octave general purpose gain block. Nine 122 $\mu$ m gate width FETs provide 11dB nominal gain at 3.1dB noise figure from DC to 14GHz. Typical power output is 16dBm at 1dB gain compression. Typical input SWR is 1.2:1 and output SWR is 1.3:1. Ground is provided to the circuitry through vias to the backside metallization. The DC to 14GHz frequency range, dual gate AGC control and gain flatness characteristics make the TGA8349-SCC suitable for many system applications including fiber optic.

The TGA8349-SCC is supplied in chip form and is engineered for high volume automated assembly. All metal surfaces are gold plated to be compatible with thermocompression and thermosonic wire bonding processes.

**TYPICAL  
SMALL SIGNAL  
POWER GAIN**

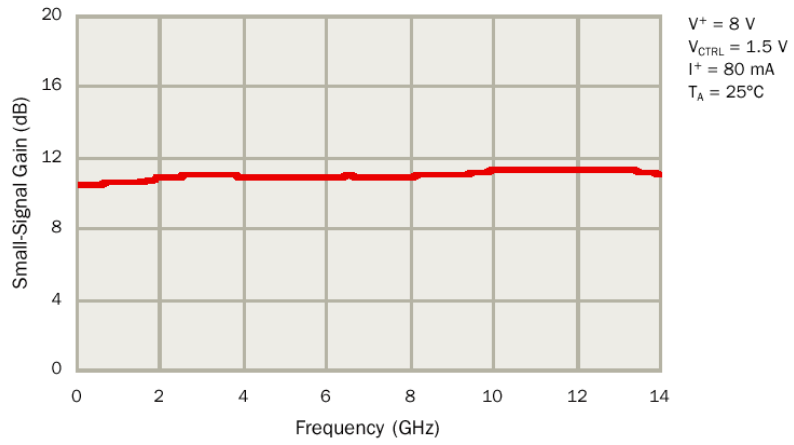

**TYPICAL  
NOISE FIGURE**

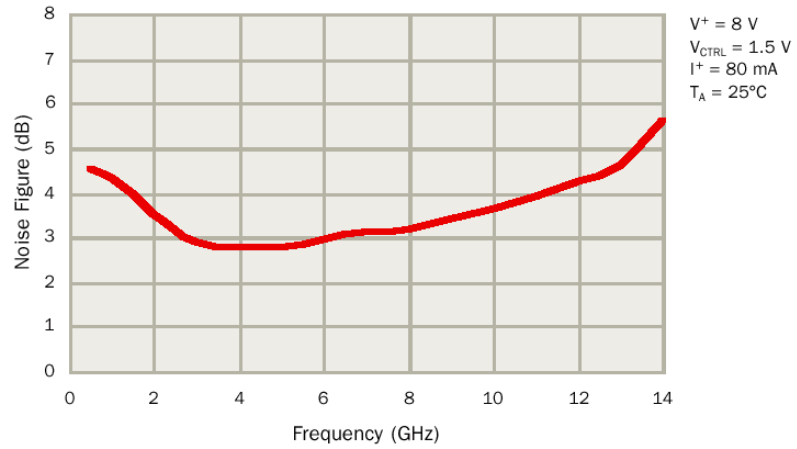

**TYPICAL  
OUTPUT POWER  
P<sub>1dB</sub>**

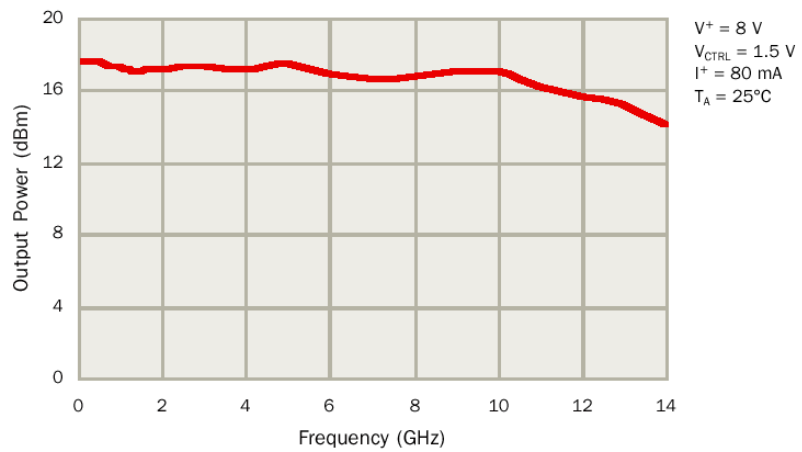

**TYPICAL  
RETURN LOSS**

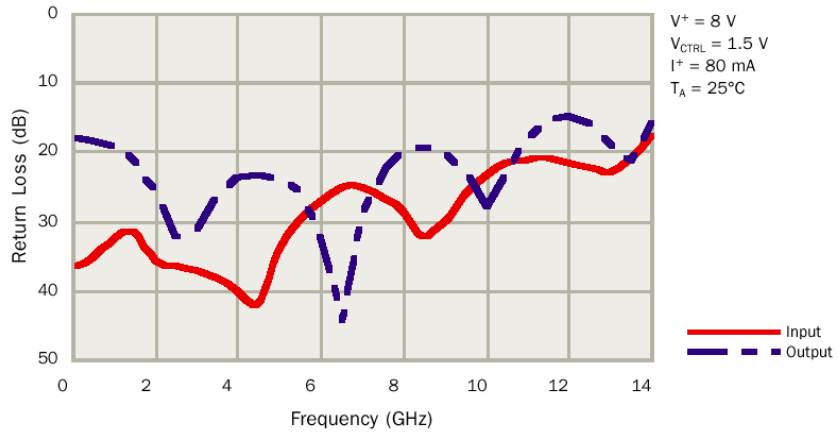

**TABLE I  
MAXIMUM RATINGS**

SYMBOL	PARAMETER	VALUE
$V^+$	POSITIVE SUPPLY VOLTAGE	13V
$V^+ - V^-$	POSITIVE SUPPLY VOLTAGE RANGE WITH RESPECT TO NEGATIVE SUPPLY VOLTAGE	0V to 13V
$V_{CTRL} - V^+$	POSITIVE SUPPLY VOLTAGE WITH RESPECT TO GAIN CONTROL VOLTAGE	0V to -13V
$V_{G1}$	NEGATIVE SUPPLY VOLTAGE RANGE	-5V to 0V
$V_{CTRL}$	GAIN CONTROL VOLTAGE RANGE	-5V to 4V
$I^+$	POSITIVE SUPPLY CURRENT	144mA
$I^-$	NEGATIVE SUPPLY CURRENT	-8.73mA
$P_D$	POWER DISSIPATION, AT (OR BELOW) 25°C BASE-PLATE TEMPERATURE *	2.6W
$T_{CH}$ **	OPERATING CHANNEL TEMPERATURE	150 °C
$T_M$	MOUNTING TEMPERATURE (30 SECONDS)	320 °C
$T_{STG}$	STORAGE TEMPERATURE	-65 to 150 °C

**Ratings over channel temperature range,  $T_{CH}$  (unless otherwise noted)**

Stresses beyond those listed under “Maximum Ratings” may cause permanent damage to the device.

These are stress ratings only, and functional operation of the device at these or any other conditions beyond those indicated under “RF Specifications” is not implied. Exposure to maximum rated conditions for extended periods may affect device reliability.

\*For operation above 25°C base-plate temperature, derate linearly at the rate of 5.5mW/°C.

\*\* Operating channel temperature,  $T_{CH}$ , directly affects the device MTTF. For maximum life, it is recommended that channel temperature be maintained at the lowest possible level.

### TYPICAL S-PARAMETERS

Frequency (GHz)	S <sub>11</sub>		S <sub>21</sub>		S <sub>12</sub>		S <sub>22</sub>		GAIN (dB)
	MAG	ANG(°)	MAG	ANG(°)	MAG	ANG(°)	MAG	ANG(°)	
0.1	0.02	115	3.32	173	0.001	85	0.12	180	10.4
0.5	0.02	92	3.34	155	0.003	73	0.12	161	10.5
1.0	0.02	26	3.36	130	0.005	53	0.11	142	10.5
1.5	0.03	-28	3.40	106	0.008	31	0.09	112	10.6
2.0	0.02	-72	3.46	80	0.011	6	0.05	80	10.8
2.5	0.02	-122	3.51	54	0.013	-20	0.02	21	10.9
3.0	0.01	-165	3.52	28	0.015	-46	0.03	-73	10.9
3.5	0.01	139	3.53	2	0.017	-71	0.05	-118	10.9
4.0	0.01	87	3.51	-24	0.019	-97	0.07	-151	10.9
4.5	0.01	12	3.48	-50	0.021	-121	0.07	-180	10.8
5.0	0.02	-74	3.48	-76	0.024	-146	0.06	155	10.8
5.5	0.03	-112	3.48	-101	0.026	-170	0.05	132	10.8
6.0	0.04	-142	3.49	-127	0.029	166	0.03	106	10.9
6.5	0.06	-167	3.52	-154	0.032	144	0.01	-123	10.9
7.0	0.05	167	3.51	180	0.035	120	0.04	-120	10.9
7.5	0.05	150	3.51	154	0.037	95	0.07	-139	10.9
8.0	0.04	141	3.51	127	0.039	71	0.10	-158	10.9
8.5	0.02	163	3.52	100	0.041	46	0.11	-177	10.9
9.0	0.03	-166	3.54	73	0.043	21	0.10	165	11.0
9.5	0.05	-162	3.58	46	0.045	-6	0.07	155	11.1
10.0	0.07	-167	3.63	18	0.047	-34	0.04	179	11.2
10.5	0.08	177	3.63	-11	0.049	-60	0.07	-142	11.2
11.0	0.09	167	3.68	-39	0.054	-89	0.12	-142	11.3
11.5	0.09	156	3.68	-69	0.057	-117	0.17	-160	11.3
12.0	0.08	149	3.68	-99	0.061	-144	0.18	-179	11.3
12.5	0.08	148	3.67	-129	0.066	-172	0.16	163	11.3
13.0	0.07	160	3.65	-160	0.069	160	0.11	156	11.3
13.5	0.09	174	3.63	168	0.072	131	0.09	-172	11.2
14.0	0.13	168	3.57	135	0.072	100	0.16	-156	11.0
14.5	0.16	151	3.46	101	0.072	68	0.23	-171	10.8
15.0	0.15	131	3.36	67	0.070	35	0.25	171	10.5
15.5	0.10	126	3.31	30	0.071	0	0.19	161	10.4
16.0	0.10	160	3.13	-10	0.069	-40	0.16	-171	9.9

V\* = 8 V, V<sub>CTRL</sub> = 1.5 V, I\* = 80 mA, T<sub>A</sub> = 25°C

Reference planes for S-parameter data include bond wires as specified in the "Recommended Assembly Diagram."

### RF CHARACTERISTICS

PARAMETER		TEST CONDITIONS	TYP	UNIT
$G_P$	Small-signal power gain	$f = DC \text{ to } 14 \text{ GHz}$	11	dB
SWR(in)	Input standing wave ratio	$f = DC \text{ to } 14 \text{ GHz}$	1.2:1	-
SWR(out)	Output standing wave ratio	$f = DC \text{ to } 14 \text{ GHz}$	1.3:1	-
$P_{1dB}$	Output power at 1-dB gain compression	$f = 7 \text{ GHz}$	16	dBm
NF	Noise figure	$f = 7 \text{ GHz}$	3.1	dB
Output third harmonic at Pin = -2 dBm		$f_o = 1 \text{ GHz}$	-51	dBc*
		$f_o = 3 \text{ GHz}$	-47	
		$f_o = 5 \text{ GHz}$	-48	
Output second harmonic at Pin = -2 dBm		$f_o = 1 \text{ GHz}$	-26	dBc*
		$f_o = 3 \text{ GHz}$	-27	
		$f_o = 5 \text{ GHz}$	-28	

$V^* = 8 \text{ V}$ ,  $V_{CTRL} = 1.5 \text{ V}$ ,  $I^* = 80 \text{ mA}$   $T_A = 25^\circ\text{C}$  (unless otherwise noted)

\* Unit dBc applies to decibels with respect to the carrier or fundamental frequency,  $f_o$

### DC CHARACTERISTICS

PARAMETER	TEST CONDITIONS	MIN	MAX	UNIT
$I_{DSS}$	Total zero-gate-voltage drain current at saturation $V_{DS} = 0.5 \text{ V to } 3.5 \text{ V}$ , $V_{GS} = 0 \text{ V}$	131	395	mA

$T_A = 25^\circ\text{C}$

$V_{DS}$  for  $I_{DSS}$  is the drain voltage between 0.5 V and 3.5 V at which drain current is highest at DC autoprobe.

### THERMAL DATA

PARAMETER	TEST CONDITIONS	FET	MMIC	UNIT
		$R_{jc}$	Thermal resistance, channel-to-backside $V^+ = 8 \text{ V}$ Base = $70^\circ\text{C}$	
	$V_{DS(FET)} = 6.18 \text{ V}$ , $I_{D(FET)} = 5 \text{ mA}$ , channel = $79.6^\circ\text{C}$	311.4	34.6	$^\circ\text{C/W}$
	$V_{DS(FET)} = 5.08 \text{ V}$ , $I_{D(FET)} = 8 \text{ mA}$ , channel = $82.8^\circ\text{C}$	314.0	35.0	
	$V_{DS(FET)} = 4.36 \text{ V}$ , $I_{D(FET)} = 10 \text{ mA}$ , channel = $83.8^\circ\text{C}$	315.7	35.2	

PARAMETER	TEST CONDITIONS	$R_{(RES)}$	UNIT
$R_{(RES)}$	Thermal resistance of drain termination resistor, 37.7		
	$V_{RES} = 1.70 \text{ V}$ , $I_{D(MMIC)} = 45 \text{ mA}$ , Base = $70^\circ\text{C}$ , $R_{jc} = 89.5^\circ\text{C/W}$	76.8	$^\circ\text{C/W}$
	$V_{RES} = 2.71 \text{ V}$ , $I_{D(MMIC)} = 72 \text{ mA}$ , Base = $70^\circ\text{C}$ , $R_{jc} = 89.7^\circ\text{C/W}$	87.5	
	$V_{RES} = 3.39 \text{ V}$ , $I_{D(MMIC)} = 90 \text{ mA}$ , Base = $70^\circ\text{C}$ , $R_{jc} = 90.2^\circ\text{C/W}$	97.5	

MMIC mounted with 38 m AuSn solder to carrier.

$$I_{D(MMIC)} = 9 \times I_{D(FET)}$$

**EQUIVALENT SCHEMATIC**

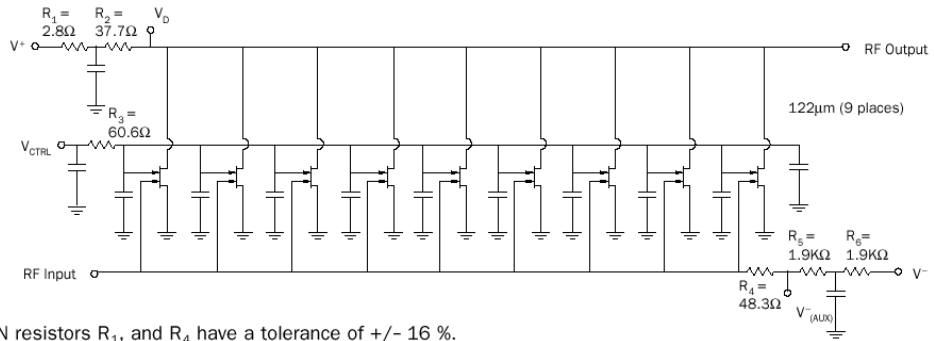

TaN resistors  $R_1$ , and  $R_4$  have a tolerance of +/- 16 %.  
GaAs resistors  $R_2$ ,  $R_3$ ,  $R_5$ , and  $R_6$  have a tolerance of +/- 30 %.

**RECOMMENDED ASSEMBLY DIAGRAM**

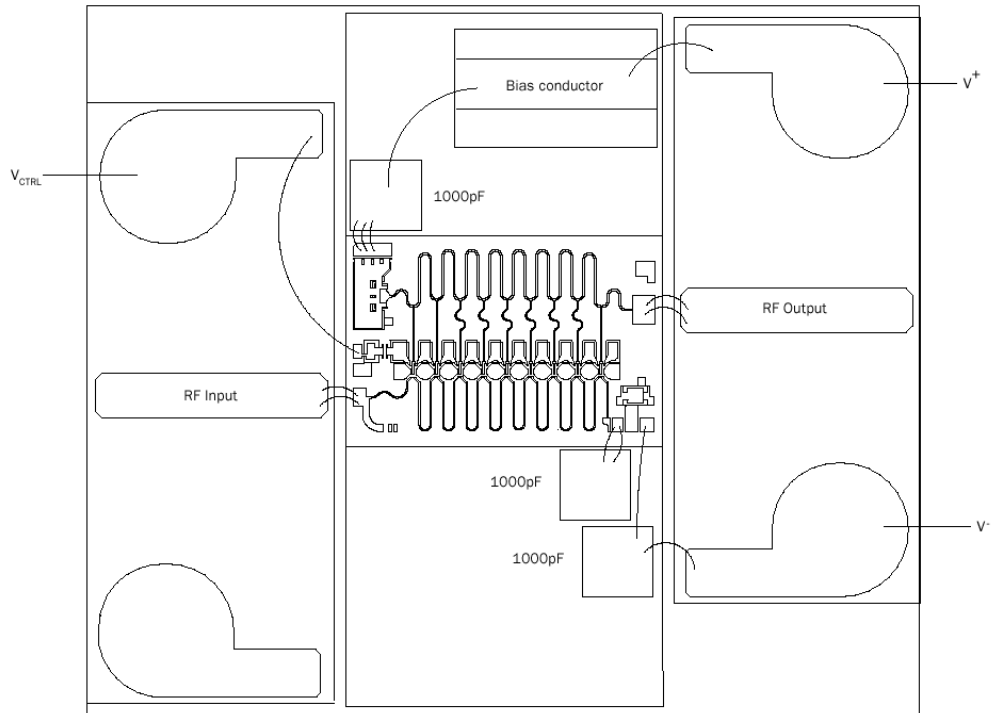

RF connections: Thermocompression bond using two 1-mil diameter, 20 to 30-mil-length gold bond wires at RF Input and at RF Output for optimum RF performance.

Close placement of this capacitor is critical for performance.

**GaAs MMIC devices are susceptible to damage from Electrostatic Discharge. Proper precautions should be observed during handling, assembly and test.**

**MECHANICAL DRAWING**

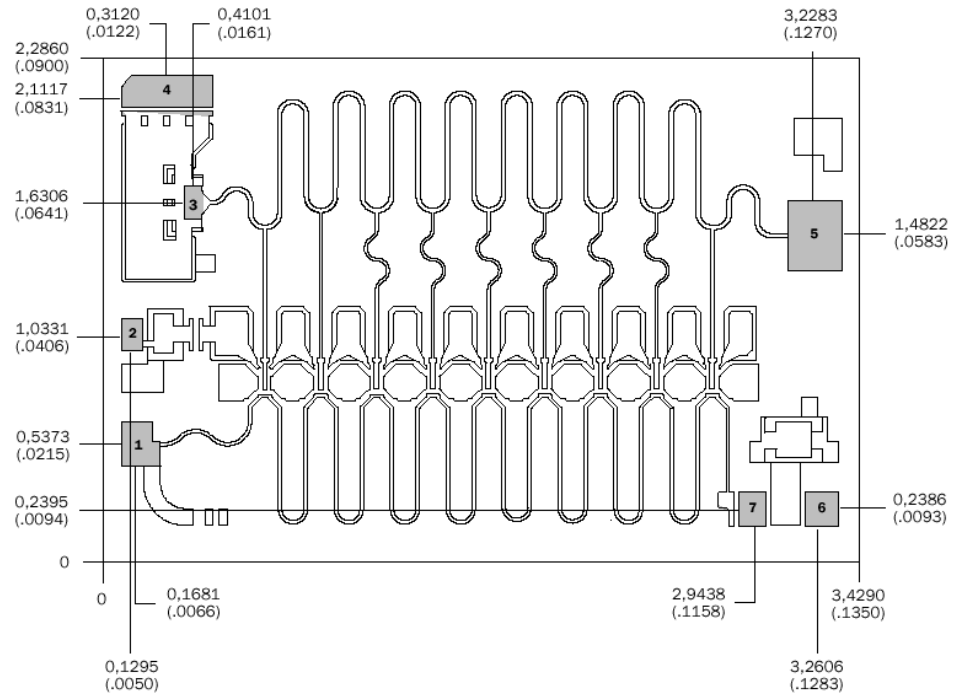

Units: Millimeters (inches)  
 Thickness: 0,1016 (0.004) (reference only)  
 Chip edge to bond pad dimensions are shown to center of bond pad  
 Chip size tolerance: ± 0,0508 (0.002)

Bond pad #1 (RF Input):	0,152 x 0,203 (0.006 x 0.008)
Bond pad #2 ( $V_{CTRL}$ ):	0,102 x 0,152 (0.004 x 0.006)
Bond pad #3 ( $V_D$ ):	0,076 x 0,152 (0.003 x 0.006)
Bond pad #4 ( $V^+$ ):	0,419 x 0,152 (0.016 x 0.006)
Bond pad #5 (RF Output):	0,254 x 0,330 (0.010 x 0.013)
Bond pad #6 ( $V^-$ ):	0,152 x 0,152 (0.006 x 0.006)
Bond pad #7 ( $V^-_{(AUX)}$ ):	0,127 x 0,152 (0.005 x 0.006)

**GaAs MMIC devices are susceptible to damage from Electrostatic Discharge. Proper precautions should be observed during handling, assembly and test.**