



1.2A, Current-Limited, High-Side P-Channel Switch with Thermal Shutdown

General Description

The MAX890L smart, low-voltage, P-channel, MOSFET power switch is intended for high-side load-switching applications. This switch operates with inputs from +2.7V to +5.5V, making it ideal for both +3V and +5V systems. Internal current-limiting circuitry protects the input supply against overload. Thermal-overload protection limits power dissipation and junction temperatures.

The MAX890L's maximum current limit is 1.2A. The current limit through the switch is programmed with a resistor from SET to ground. The quiescent supply current is a low 10 μ A. When the switch is off, the supply current decreases to 0.1 μ A.

The MAX890L is available in an 8-pin SO package.

Applications

PCMCIA Slots
Access Bus Slots
Portable Equipment

Features

- ◆ +2.7V to +5.5V Input Range
- ◆ Programmable Current Limit
- ◆ Low Quiescent Current
 - 10 μ A (typ) at $V_{IN} = +3.3V$
 - 0.1 μ A (typ) with Switch Off
- ◆ Thermal Shutdown
- ◆ FAULT Indicator Output
- ◆ 0.09 Ω (typ) On-Resistance

Ordering Information

PART	TEMP RANGE	PIN-PACKAGE	CURRENT LIMIT
MAX890LC/D	0°C to +70°C	Dice**	1.2A
MAX890LESA+	-40°C to +85°C	8 SO	1.2A
MAX890LESANV+	-40°C to +85°C	8 SO	1.2A

*To order this unit in tape and reel, add (T) to the end of the part number.

**Dice are tested at $T_A = +25^\circ\text{C}$.

+Denotes a lead(Pb)-free/RoHS-compliant package.

V denotes an automotive qualified part.

Typical Operating Circuit

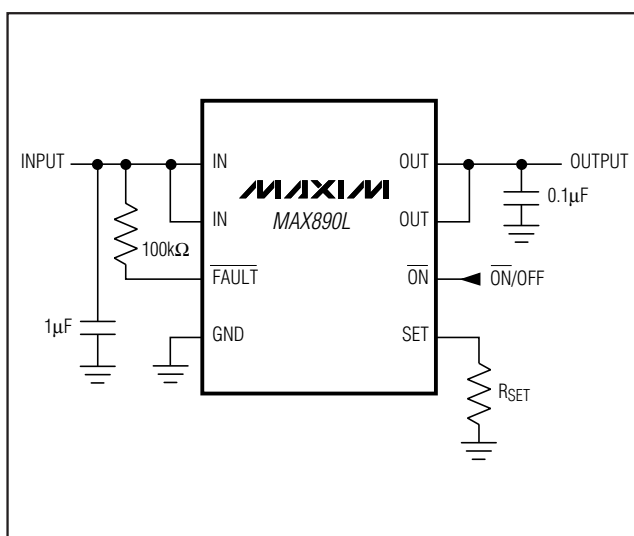

Pin Configuration

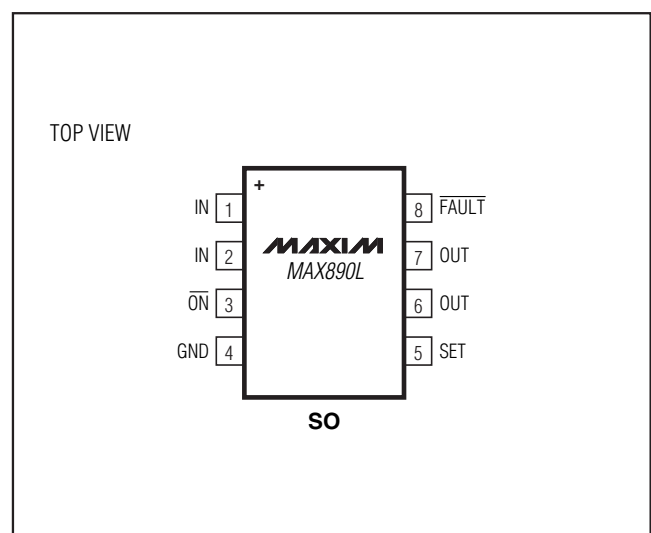

1.2A, Current-Limited, High-Side P-Channel Switch with Thermal Shutdown

ABSOLUTE MAXIMUM RATINGS

IN to GND	-0.3V to +6V
ON, FAULT to GND	-0.3V to +6V
SET, OUT to GND	-0.3V to (V _{IN} + 0.3V)
Maximum Continuous Switch Current	1.5A
Continuous Power Dissipation (T _A = +70°C) SO (derate 5.88mW/°C above +70°C)	471mW

Operating Temperature Range MAX890LESA	-40°C to +85°C
Storage Temperature Range	-65°C to +150°C
Lead Temperature (soldering, 10s)	+300°C
Soldering Temperature (reflow)	+260°C

Stresses beyond those listed under "Absolute Maximum Ratings" may cause permanent damage to the device. These are stress ratings only, and functional operation of the device at these or any other conditions beyond those indicated in the operational sections of the specifications is not implied. Exposure to absolute maximum rating conditions for extended periods may affect device reliability.

ELECTRICAL CHARACTERISTICS

(V_{IN} = +3V, T_A = 0°C to +85°C, unless otherwise noted. Typical values are at T_A = +25°C.)

PARAMETER	CONDITIONS	MIN	TYP	MAX	UNITS
Operating Voltage		2.7		5.5	V
Quiescent Current	V _{IN} = 5V, $\overline{\text{ON}}$ = GND, I _{OUT} = 0A		13	20	μA
Off-Supply Current	$\overline{\text{ON}}$ = IN, V _{IN} = V _{OUT} = 5.5V		0.03	1	μA
Off-Switch Current	$\overline{\text{ON}}$ = IN, V _{IN} = 5.5V, V _{OUT} = 0V		0.04	15	μA
Undervoltage Lockout	Rising edge, 1% hysteresis	2.0	2.4	2.6	V
On-Resistance	V _{IN} = 4.5V		75	130	mΩ
	V _{IN} = 3.0V		90	150	
Current-Limit-Amplifier Threshold	V _{SET} required to turn the switch off (Note 1)	1.178	1.240	1.302	V
Maximum Output Current Limit			1.2		A
I _{OUT} to I _{SET} Current Ratio	I _{OUT} = 500mA, V _{OUT} > 1.6V	970	1110	1300	A/A
$\overline{\text{ON}}$ Input Low Voltage	V _{IN} = 2.7V to 5.5V			0.8	V
$\overline{\text{ON}}$ Input High Voltage	V _{IN} = 2.7V to 3.6V	2.0			V
	V _{IN} = 4.5V to 5.5V	2.4			
$\overline{\text{ON}}$ Input Leakage Current	V $\overline{\text{ON}}$ = 5.5V		0.01	1	μA
I _{SET} Bias Current	V _{SET} = 1.24V, I _{OUT} = 0A; V _{IN} = V _{OUT}		0.5	3	μA
$\overline{\text{FAULT}}$ Logic Output Low Voltage	I _{SINK} = 1mA, V _{SET} = 1.4V			0.4	V
$\overline{\text{FAULT}}$ Logic Output High Leakage Current	V $\overline{\text{FAULT}}$ = 5.5V, V _{SET} = 1V		0.05	1	μA
Slow-Current-Loop Response Time	20% current overdrive, V _{CC} = 5V		5		μs
Fast-Current-Loop Response Time			2		μs
Turn-On Time	V _{IN} = 5V, I _{OUT} = 500mA		120	200	μs
	V _{IN} = 3V, I _{OUT} = 500mA		185		
Turn-Off Time	V _{IN} = 5V	2	5		μs

1.2A, Current-Limited, High-Side P-Channel Switch with Thermal Shutdown

MAX890L

ELECTRICAL CHARACTERISTICS

($V_{IN} = +3V$, $T_A = -40^{\circ}C$ to $+85^{\circ}C$, unless otherwise noted.) (Note 2)

PARAMETER	CONDITIONS	MIN	TYP	MAX	UNITS
Operating Voltage		3.0		5.5	V
Quiescent Current	$V_{IN} = 5V$, $\overline{ON} = GND$, $I_{OUT} = 0A$			50	μA
Off-Supply Current	$\overline{ON} = IN$, $V_{IN} = V_{OUT} = 5.5V$			2.2	μA
Off-Switch Current	$\overline{ON} = IN$, $V_{IN} = 5.5V$, $V_{OUT} = 0V$			15	μA
Undervoltage Lockout	Rising edge, 1% hysteresis	2.0		2.9	V
On-Resistance	$V_{IN} = 4.5V$			130	m Ω
	$V_{IN} = 3.0V$			150	
Current-Limit-Amplifier Threshold	V_{SET} required to turn the switch off (Note 1)	1.14		1.34	V
I_{OUT} to I_{SET} Current Ratio	$I_{OUT} = 500mA$, $V_{OUT} > 1.6V$	925		1390	A/A
\overline{FAULT} Logic Output Low Voltage	$I_{SINK} = 1mA$, $V_{SET} = 1.4V$			0.4	V
Turn-On Time	$V_{IN} = 5V$			200	μs
Turn-Off Time	$V_{IN} = 5V$	1		20	μs

Note 1: Tested with $I_{OUT} = 100mA$ and V_{SET} raised until $V_{IN} - V_{OUT} \geq 0.8V$.

Note 2: Specifications to $-40^{\circ}C$ are guaranteed by design; not production tested.

1.2A, Current-Limited, High-Side P-Channel Switch with Thermal Shutdown

Typical Operating Characteristics

($T_A = +25^\circ\text{C}$, unless otherwise noted.)

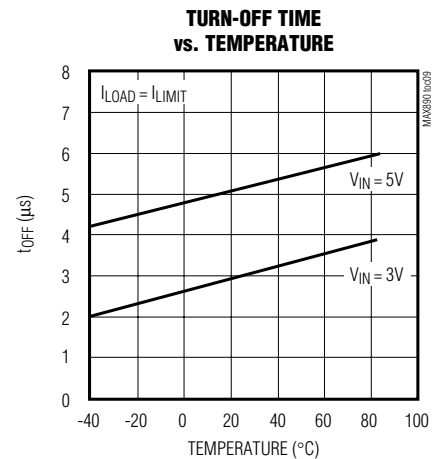
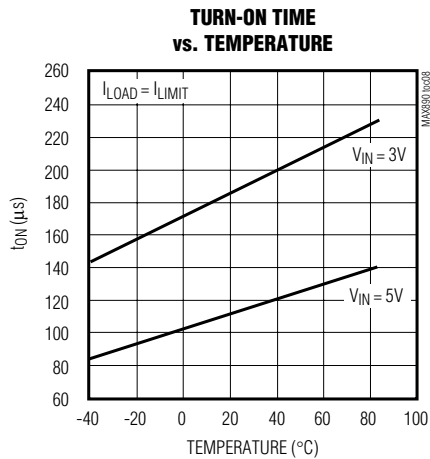
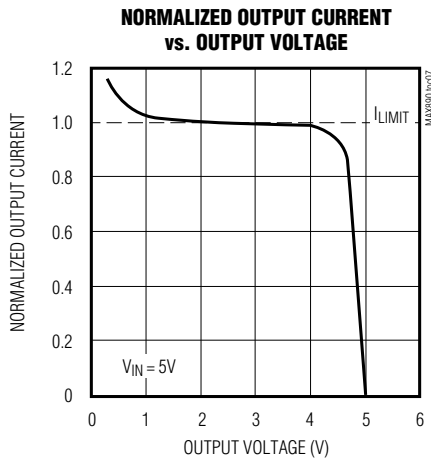
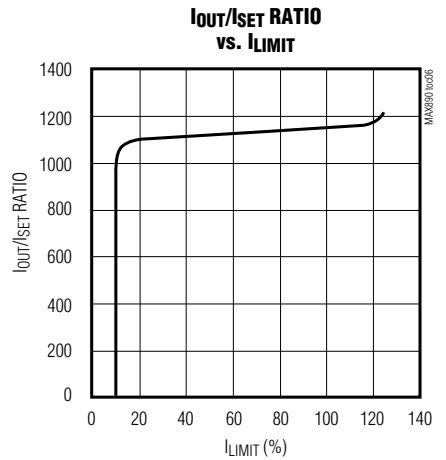
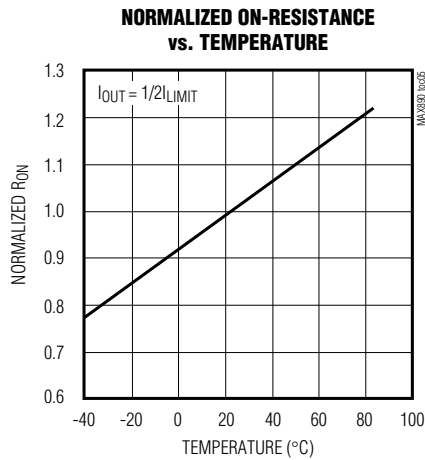
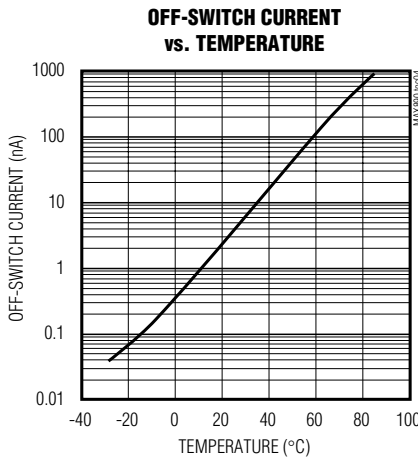
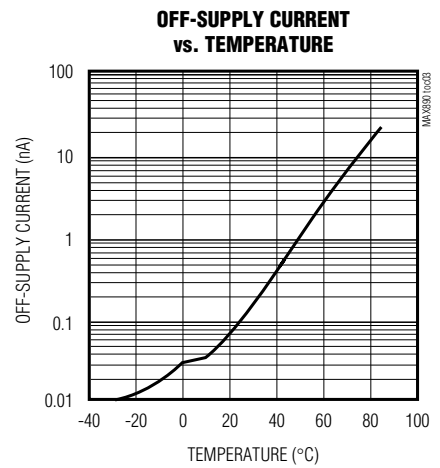
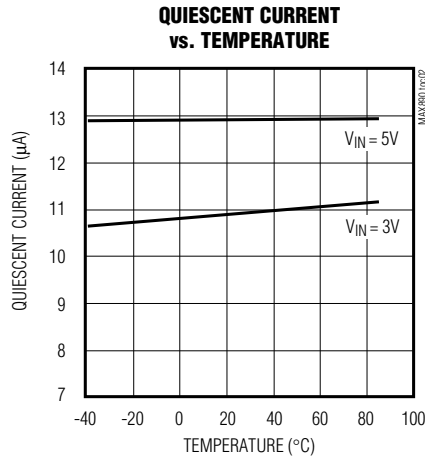
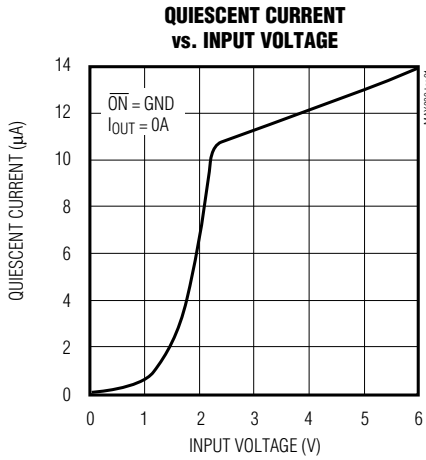

1.2A, Current-Limited, High-Side P-Channel Switch with Thermal Shutdown

MAX890L

Typical Operating Characteristics (continued)

($T_A = +25^\circ\text{C}$, unless otherwise noted.)

OUTPUT OVERLOAD (SLOW LOOP RESPONSE)

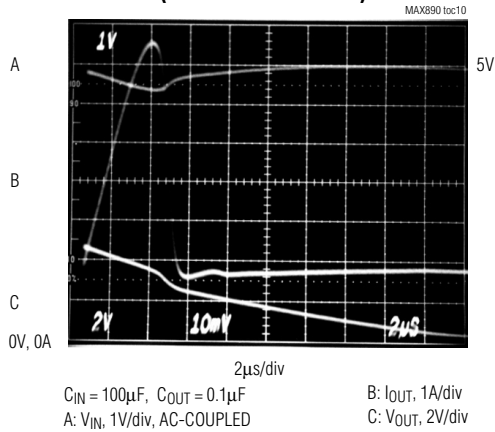

OUTPUT SHORT-CIRCUIT (FAST LOOP RESPONSE)

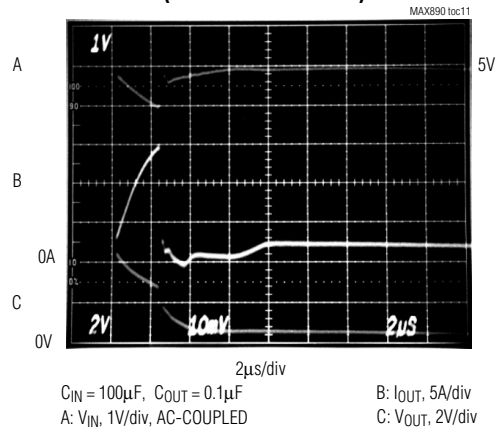

LOAD-TRANSIENT RESPONSE

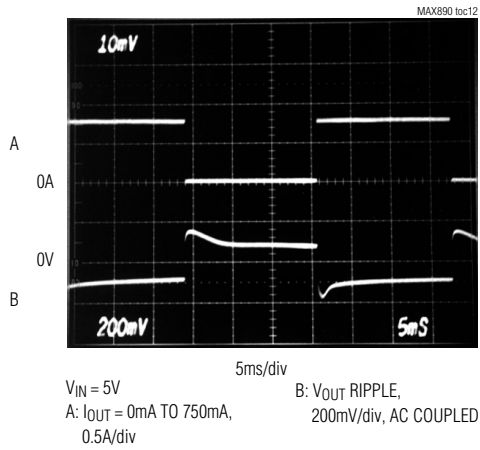

SWITCH TURN-ON TIME

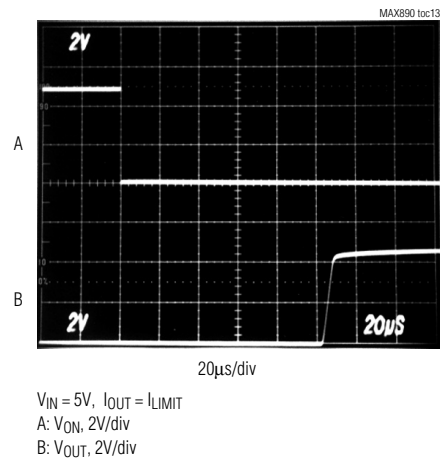

SWITCH TURN-OFF TIME

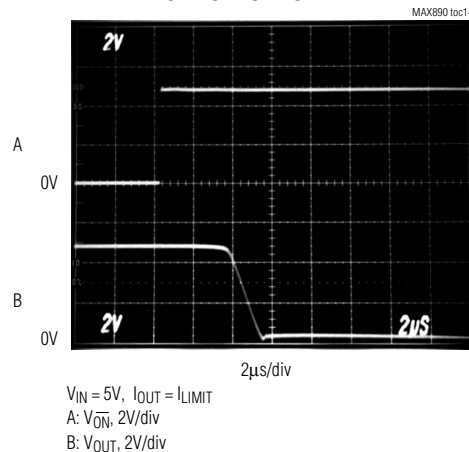

1.2A, Current-Limited, High-Side P-Channel Switch with Thermal Shutdown

Pin Description

PIN	NAME	FUNCTION
1, 2	IN	Input. P-channel MOSFET source. Bypass IN with a 1μF capacitor to ground.
3	$\overline{\text{ON}}$	Active-Low Switch On Input. A logic low turns the switch on.
4	GND	Ground
5	SET	Set Current-Limit Input. A resistor from SET to ground sets the current limit for the switch. $R_{\text{SET}} = 1.38 \times 10^3 / I_{\text{LIMIT}}$, where I_{LIMIT} is the desired current limit in amperes.
6, 7	OUT	Switch Output. P-channel MOSFET drain. Bypass OUT with a 0.1μF capacitor to ground.
8	$\overline{\text{FAULT}}$	Fault-Indicator Output. This open-drain output goes low when in current limit or when the die temperature exceeds +135°C.

Detailed Description

The MAX890L P-channel MOSFET power switch limits output current to a programmed level. When the output current is increased beyond the programmed current limit, or 1.2A (I_{MAX}), the current also increases through the replica switch ($I_{\text{OUT}}/1110$) and through R_{SET} (Figure 1). The current-limit error amplifier compares the voltage across R_{SET} to the internal +1.24V reference and regulates the current back to the lesser of the programmed limit (I_{LIMIT}) or 1.2A.

This switch is not bidirectional; therefore, the input voltage must be higher than the output voltage.

Setting the Current Limit

The MAX890L features internal current-limiting circuitry with a maximum programmable value (I_{MAX}) of 1.2A. For best performance, set the current limit (I_{LIMIT}) between $0.2 I_{\text{MAX}} \leq I_{\text{LIMIT}} \leq I_{\text{MAX}}$. This current limit remains in effect throughout the input supply-voltage range.

Program the current limit with a resistor (R_{SET}) from SET to ground (Figure 2) as follows:

$$I_{\text{SET}} = I_{\text{LIMIT}} / 1110$$

$$R_{\text{SET}} = 1.24\text{V} / I_{\text{g}} = 1.38 \times 10^3 / I_{\text{LIMIT}}$$

where I_{LIMIT} is the desired current limit.

Short-Circuit Protection

The MAX890L is a short-circuit-protected switch. In the event of an output short circuit or current-overload condition, the current through the switch is limited by the internal current-limiting error amplifier to $1.5 \times I_{\text{LIMIT}}$. When the fault condition is removed, the replica error amplifier sets the current limit back to I_{LIMIT} .

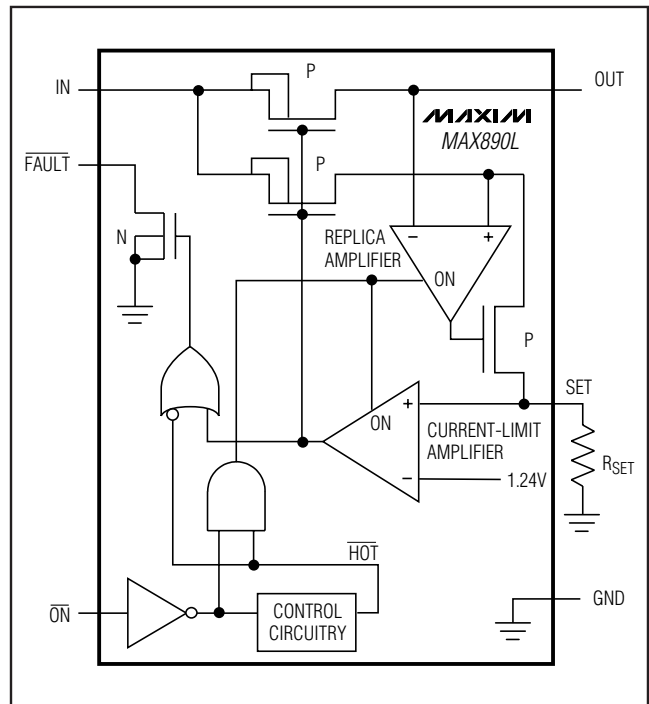

Figure 1. Functional Diagram

For a high dV_{DS}/dt during an output short-circuit condition, the switch turns off and disconnects the input supply from the output. The current-limiting amplifier then slowly turns the switch on with the output current limited to $1.5 \times I_{\text{LIMIT}}$. When the fault condition is removed, the current limit is set back to I_{LIMIT} . Refer to the Output Short-Circuit Fast-Loop Response and Output Overload Slow-Loop Response in the *Typical Operating Characteristics*.

1.2A, Current-Limited, High-Side P-Channel Switch with Thermal Shutdown

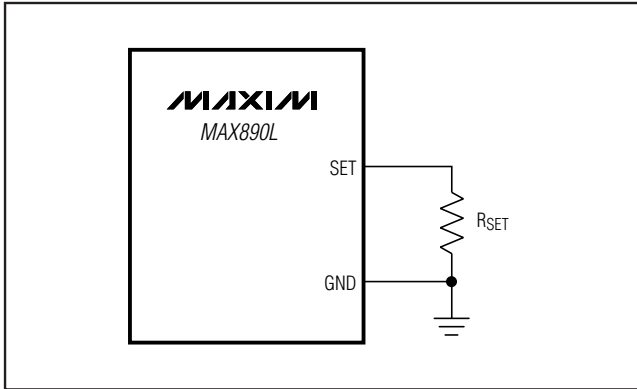

Figure 2. Setting the Current Limit

Thermal Shutdown

The MAX890L features thermal shutdown. The switch turns off when the junction temperature exceeds +135°C. Once the device cools by 10°C, the switch turns back on. If the fault short-circuit condition is not removed, the switch cycles on and off, resulting in a pulsed output.

Fault Indicator

The MAX890L provides a fault output (FAULT). This open-drain output goes low when in current limit or when the die temperature exceeds +135°C. A 100kΩ pull-up resistor from FAULT to IN provides a logic-control signal.

Applications Information

Input Capacitor

To limit the input voltage drop during momentary output short-circuit conditions, connect a capacitor from IN to GND. A 1μF ceramic capacitor is adequate for most applications; however, higher capacitor values further reduce the voltage drop at the input.

Output Capacitor

Connect a 0.1μF capacitor from OUT to GND. One function of this capacitor is to prevent inductive parasitics from pulling OUT negative during turn-off.

Layout and Thermal-Dissipation Consideration

To take full advantage of the switch-response time to output short-circuit conditions, it is very important to keep all traces as short as possible to reduce the effect of undesirable parasitic inductance. Place input and output capacitors as close as possible to the device (no more than 5mm).

Under normal operating conditions, the package can dissipate and channel heat away. Calculate the maximum power as follows:

$$P = I_{LIMIT}^2 \times R_{ON}$$

where R_{ON} is the on-resistance of the switch.

When the output is short circuited, the voltage drop across the switch equals the input supply. Hence, the power dissipated across the switch increases, as does the die temperature. If the fault condition is not removed, the thermal-overload-protection circuitry turns the switch off until the die temperature falls by 10°C. A ground plane in contact with the device helps dissipate additional heat.

Package Information

For the latest package outline information and land patterns (footprints), go to www.maxim-ic.com/packages. Note that a "+", "#", or "-" in the package code indicates RoHS status only. Package drawings may show a different suffix character, but the drawing pertains to the package regardless of RoHS status.

PACKAGE TYPE	PACKAGE CODE	OUTLINE NO.	LAND PATTERN NO.
8 SO	S8+5	21-0041	90-0096

1.2A, Current-Limited, High-Side P-Channel Switch with Thermal Shutdown

Revision History

REVISION NUMBER	REVISION DATE	DESCRIPTION	PAGES CHANGED
4	4/11	Added the MAX890LESA/V+ part number to the <i>Ordering Information</i> , deleted the <i>Chip Information</i> section	1, 7

Maxim cannot assume responsibility for use of any circuitry other than circuitry entirely embodied in a Maxim product. No circuit patent licenses are implied. Maxim reserves the right to change the circuitry and specifications without notice at any time.

8 **Maxim Integrated Products, 120 San Gabriel Drive, Sunnyvale, CA 94086 408-737-7600**