

Miniature Square Photoelectric Sensor in plastic housing

E3T

- Ultra flat size with high power pinpoint LED where space is crucial
- 3.5 mm thin flat shape
- IP67
- Pulse synchronisation for high ambient light immunity



Features

Flat background suppression (BGS) with highest repeatability even for differently colored objects.

Minimal black white error

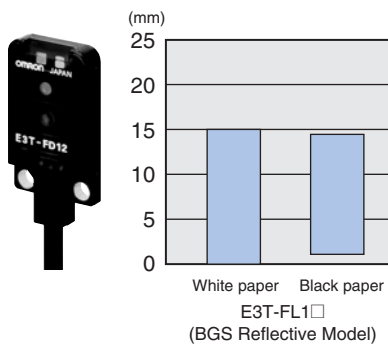

Unique light receiving lens shape for high precision alignment

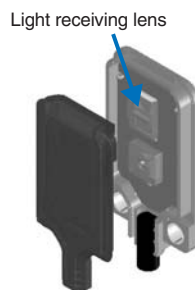

New mounting technology for reliable background suppressions in 3.5 mm flat housing

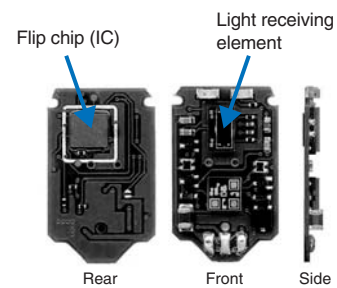

Application

E3T-ST Through-beam (Side View) Models/E3T-FT Through-beam (Flat) Models

- Long-distance detection Side-view Models: 1m, Flat Models: 500 mm.
- Minimum detection object: 0.5 mm dia. (with slit attached).
- Optical axis accuracy of $\pm 2^\circ$ for high installation reliability.



Application

E3T-SL Convergent-reflective Models (Side-view)

- Minimum detection object: 0.15 mm dia.
- Resistant to background and surrounding metal.



E3T-FD Diffuse-reflective Models (Flat)



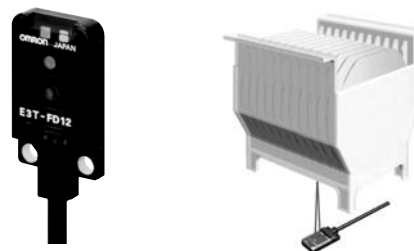







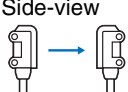



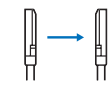



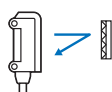

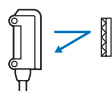
- Minimum detection object: 0.15 mm dia.
- Only 3.5 mm wide for installation in small gaps.

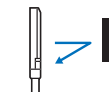

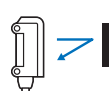
Ordering Information

Sensors

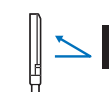
Red light

Sensing method	Appearance		Connection method	Sensing distance	Operation mode	Model *1	
						NPN output	PNP output
Through-beam		Side-view 	Pre-wired	1 m  (Sensitivity Adjustment Unit can be used.)	Light-ON	E3T-ST11 *2	E3T-ST13
				Dark-ON	E3T-ST12 *2	E3T-ST14	
		300 mm 		Light-ON	E3T-ST21	E3T-ST23	
		Dark-ON		E3T-ST22	E3T-ST24		
		Flat 		500mm 	Light-ON	E3T-FT11 *2	E3T-FT13
				Dark-ON	E3T-FT12	E3T-FT14	
		300 mm 		Light-ON	E3T-FT21	E3T-FT23	
		Dark-ON		E3T-FT22	E3T-FT24		
Retro-reflective		Side-view 	 200mm [10mm]	Light-ON	E3T-SR21 *2	E3T-SR23	
				Dark-ON	E3T-SR22 *2	E3T-SR24	
		Side-view 		 100 mm [10 mm]	Light-ON	E3T-SR31 *2	E3T-SR33
					Dark-ON	E3T-SR32 *2	E3T-SR34
Diffuse-reflective		Flat 	 5 to 30 mm		Light-ON	E3T-FD11 *2	E3T-FD13
					Dark-ON	E3T-FD12 *2	E3T-FD14
Convergent-reflective		Side-view 	 5 to 15 mm	Light-ON	E3T-SL11 *2	E3T-SL13	
				Dark-ON	E3T-SL12 *2	E3T-SL14	
				 5 to 30 mm	Light-ON	E3T-SL21 *2	E3T-SL23
					Dark-ON	E3T-SL22 *2	E3T-SL24
BGS reflective		Flat 	 1 to 15 mm	Light-ON	E3T-FL11 *2	E3T-FL13	
				Dark-ON	E3T-FL12 *2	E3T-FL14	
			 1 to 30 mm	Light-ON	E3T-FL21 *2	E3T-FL23	
				Dark-ON	E3T-FL22 *2	E3T-FL24	

*1. Please contact your OMRON representative for models with M8 junction connectors.

*2. A Robotics Cable is provided. These models have an R suffix. (Example: E3T-ST11R). Models with e-CON connector are available.

*3. Values in parentheses indicate the minimum required distance between the Sensor and Reflector.

Accessories (Order Separately)

Slits

Slit width	Sensing distance (typical)	Minimum detectable object (typical)	Model	Quantity	Remarks
0.5 mm dia.	100 mm	0.5 mm dia.	E39-S63	One each for Emitter and Receiver; common with Slit widths of 1 dia. and 0.5 dia. (total of 2)	Plug-in type round slits Can be used with E3T-ST1□ Through-beam Models.
1 mm dia.	300 mm	1 mm dia.			
0.5 mm dia.	50 mm	0.5 mm dia.	E39-S64		Plug-in type round slits Can be used with E3T-FT1□ Through-beam Models.
1 mm dia.	100 mm	1 mm dia.			

Reflectors





Name	Sensing distance (Sensor model)	Minimum detectable object (typical)	Model	Quantity	Remarks
Small Reflectors	200 mm (10 mm) *1 (E3T-SR2□)	2 mm dia.	E39-R4	1	Provided with the E3T-SR2□ Retro-reflective Models.
	100 mm (10 mm) *1 (E3T-SR3□)		E39-R37		Provided with the E3T-SR3□ Retro-reflective Models.

*1. Values in parentheses indicate the minimum required distance between the Sensor and Reflector.

Sensitivity Adjustment Unit

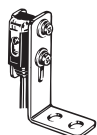
Appearance	Sensing distance (typical)	Model	Quantity	Remarks
	300 to 800 mm	E39-E10	1	Can be used with the E3T-ST1□ Through-beam Models.

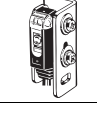
Mounting Brackets

Appearance	Model	Quantity	Remarks
	E39-L116	1	Can be used with the E3T-S□□□ Side-view Models. (A securing nut plate is provided with the Mounting Bracket.)
	E39-L117		
	E39-L118		
	E39-L119		Can be used with the E3T-F□□□ Flat Models.
	E39-L120		

Note: When using Through-beam models, order one bracket for the Receiver and one for the Emitter.

Sensor I/O Connectors

Size	Cable type	Shape	Cable length	Model	
e-CON	Standard cable	Connector on one end	2 m	4-wire	E39-ECON2M
			5 m		E39-ECON5M
		Connector on both ends	0.5 to 1 m	E39-ECONW□M Replace □ with the cable length in 0.1 m increments.	
			1.1 to 1.5 m		
			1.6 to 2 m		

Rating and Specifications

Sensing method	Through-beam				Retro-reflective			
	Side-view		Flat		Side-view			
	NPN	PNP	NPN	PNP	NPN	PNP	NPN	PNP
	E3T-ST11 E3T-ST12 E3T-ST21 E3T-ST22	E3T-ST13 E3T-ST14 E3T-ST23 E3T-ST24	E3T-FT11 E3T-FT12 E3T-FT21 E3T-FT22	E3T-FT13 E3T-FT14 E3T-FT23 E3T-FT24	E3T-SR21 E3T-SR22	E3T-SR23 E3T-SR24	E3T-SR31 E3T-SR32	E3T-SR33 E3T-SR34
Sensing distance	E3T-ST1□ 1 m E3T-ST2□ 300 mm	E3T-FT1□ 500 mm E3T-FT2□ 300 mm	E3T-SR2□200 mm (10 mm) *1 (with the E39-R4)	E3T-SR3□100 mm (10 mm) *1 (with the E39-R37)				
Standard sensing object	Opaque, 2 mm dia. min.		Opaque, 1.3 mm dia. min.		Opaque, 27 mm dia. min.			
Minimum detectable object (typical)	2 mm dia opaque object		1.3 mm dia opaque object		2 mm dia. (sensing distance of 100 mm)			
Hysteresis (white paper)	---							
Black/white error	---							
Directional angle	Emitter: 2° to 20° Receiver: 2° to 70°		Emitter: 3° to 25° Receiver: 3° min.		2° to 20°			
Light source (wavelength)	Red LED ("Pin-point" LED) λ = 650 nm							
Power supply voltage	12 to 24 VDC ±10%, ripple (p-p) 10% max.							
Current consumption	Emitter: 10 mA max. Receiver: 20 mA max.				20 mA max.			
Control output	Load power supply voltage: 26.4 VDC max. Load current: 50 mA max. (residual voltage: 2 V max. for load current of 10 to 50 mA, 1 V max. for load current of less than 10 mA) Open collector output Light ON: E3T-□□□1 and E3T-□□□3 Dark ON: E3T-□□□2 and E3T-□□□4							
Protection circuits	Power supply and control output reverse polarity protection Output short-circuit protection				Power supply and control output reverse polarity protection Output short-circuit protection, Mutual interference prevention			
Response time	Operate or reset: 1 ms max.							
Ambient illumination	Incandescent lamp: 5,000 lx max. Sunlight: 10,000 lx max.							
Ambient temperature range	Operating: -25 to 55 °C Storage: -40 to 70 °C (with no icing or condensation)							
Ambient humidity range	Operating: 35% to 85% Storage: 35% to 95% (with no condensation)							
Insulation resistance	20 MΩ min. at 500 VDC							
Dielectric strength	1,000 VAC, 50/60 Hz for 1 min							
Vibration resistance	Destruction: 10 to 2,000 Hz, 1.5 mm double amplitude or 300 m/s ² for 0.5 hrs each in X, Y, and Z directions							
Shock resistance	Destruction: 1,000 m/s ² 3 times each in X, Y, and Z directions							
Degree of protection	IP67 (IEC60529)							
Connection method	Pre-wired (standard length: 2 m)							
Weight	Approx. 40 g				Approx. 20 g			
Materials	Case	PBT (polybutylene terephthalate)						
	Display window	Denatured polyarylate						
	Lens	Denatured polyarylate				Methacrylic resin		
Accessories	Instruction manual, Installation screws (Side-view Models: M2 x 14, Flat Models: M2 x 8), Nuts, Spring washers, Flat washers, E39-R4 (E3T-SR2□ only), E39-R37 (E3T-SR3□ only)							

*1. Values in parentheses indicate the minimum required distance between Sensor and Reflector.

Sensing method	Diffuse-reflective		Convergent-reflective				BGS reflective			
	Flat		Side-view				Flat			
	NPN	PNP	NPN	PNP	NPN	PNP	NPN	PNP	NPN	PNP
	E3T-FD11 E3T-FD12	E3T-FD13 E3T-FD14	E3T-SL11 E3T-SL12	E3T-SL13 E3T-SL14	E3T-SL21 E3T-SL22	E3T-SL23 E3T-SL24	E3T-FL11 E3T-FL12	E3T-FL13 E3T-FL14	E3T-FL21 E3T-FL22	E3T-FL23 E3T-FL24
Sensing distance	5 to 30 mm (50 x 50 mm white paper)		5 to 15 mm (50 x 50 mm white paper)		5 to 30 mm (50 x 50 mm white paper)		1 to 15 mm (50 x 50 mm white paper)		1 to 30 mm (50 x 50 mm white paper)	
Standard sensing object	---									
Minimum detectable object (typical)	0.15 mm dia. (sensing distance of 10 mm)						0.15 mm dia non-glossy object (sensing distance of 10 mm)			
Hysteresis (white paper)	6 mm max.		2 mm max.		6 mm max.		0.5 mm max.		2 mm max.	
Black/white error	---								15% max.	
Directional angle	---									
Light source (wavelength)	Red LED ("Pin-point" LED) $\lambda = 650$ nm									
Power supply voltage	12 to 24 VDC $\pm 10\%$, ripple (p-p) 10% max.									
Current consumption	20 mA max.									
Control output	Load power supply voltage: 26.4 VDC max. Load current: 50 mA max. (residual voltage: 2 V max. for load current of 10 to 50 mA, 1 V max. for load current of less than 10 mA) Open-collector output Light ON: E3T-□□□1 and E3T-□□□3 Dark ON: E3T-□□□2 and E3T-□□□4									
Protection circuits	Power supply and control output reverse polarity protection Output short-circuit protection, Mutual interference prevention									
Response time	Operate or reset: 1 ms max.									
Ambient illumination	Incandescent lamp: 5,000 lx max. Sunlight: 10,000 lx max.									
Ambient temperature range	Operating: -25 to 55 °C Storage: -40 to 70 °C (with no icing or condensation)									
Ambient humidity range	Operating: 35% to 85% Storage: 35% to 95% (with no condensation)									
Insulation resistance	20 M Ω min. at 500 VDC									
Dielectric strength	1,000 VAC, 50/60 Hz for 1 min									
Vibration resistance	Destruction: 10 to 2,000 Hz, 1.5 mm double amplitude or 300 m/s ² for 0.5 hrs each in X, Y, and Z directions									
Shock resistance	Destruction: 1,000 m/s ² 3 times each in X, Y, and Z directions									
Degree of protection	IP67 (IEC60529)									
Connection method	Pre-wired (standard length: 2 m)									
Weight	Approx. 20 g									
Materials	Case	PBT (polybutylene terephthalate)								
	Display window	Denatured polyarylate								
	Lens	Denatured polyarylate								
Accessories	Instruction manual, Installation screws (Side-view Models: M2 x 14, Flat Models: M2 x 8), Nuts, Spring washers, Flat washers									

Engineering Data (Typical)

Parallel Operating Range

Through-beam

E3T-ST1□ + E39-S63 Slit
(Order Separately)

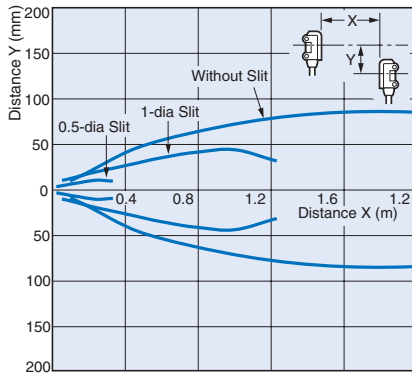

E3T-ST1□ + E39-S63 Slit
(Order Separately)(Enlarged graph)

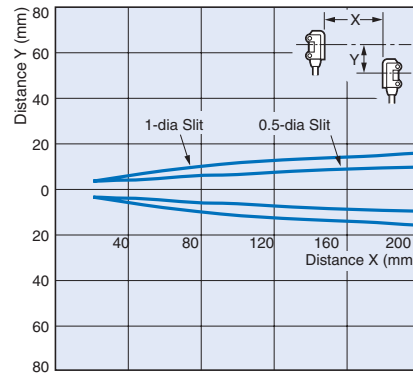

E3T-ST2□

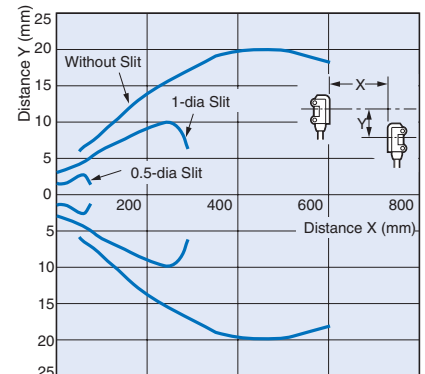

E3T-FT1□ + E39-S64 Slit
(Order Separately)

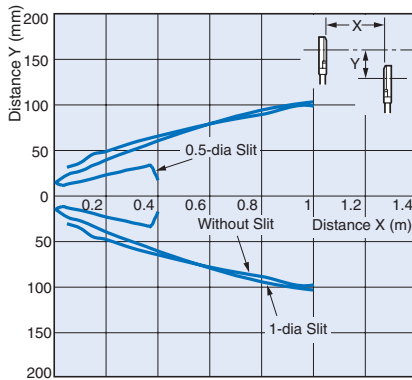

E3T-FT1□ + E39-S64 Slit
(Order Separately)(Enlarged graph)

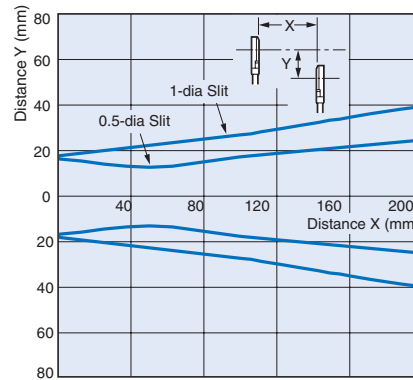

E3T-FT2□

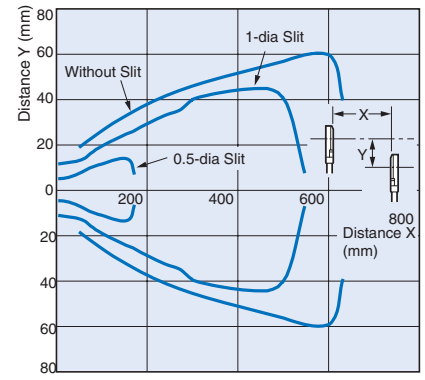

Through-beam

E3T-SR2□ + E39-R4 (Provided)

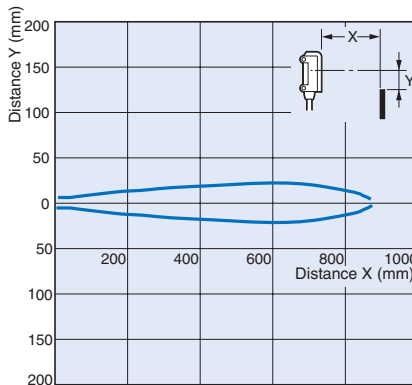

E3T-SR3□ + E39-R37 (Provided)

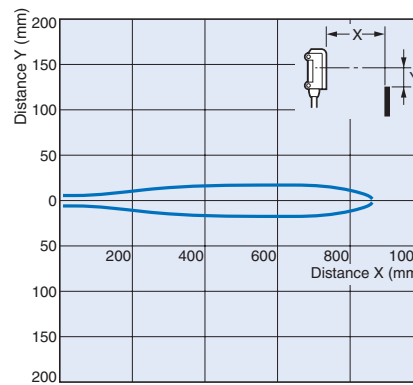

Operating Range

Diffuse-reflective

E3T-FD1□

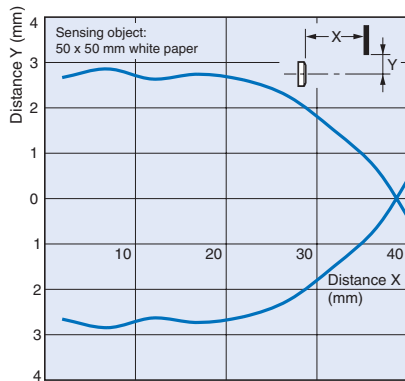

Convergent-reflective

E3T-SL1□

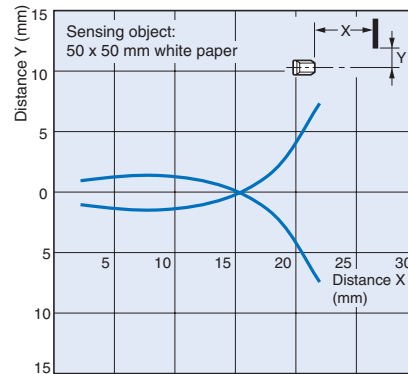

E3T-SL2□

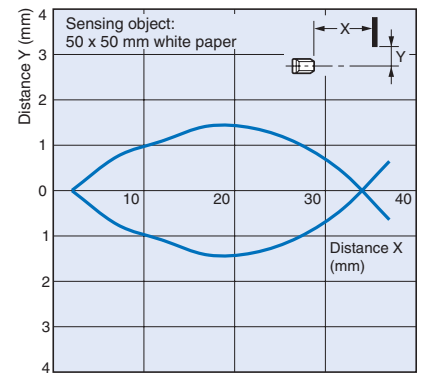

BGS Reflective

E3T-FL1□

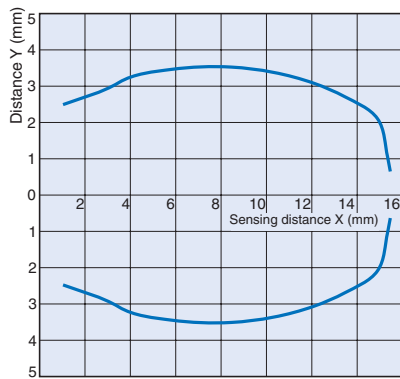

E3T-FL2□

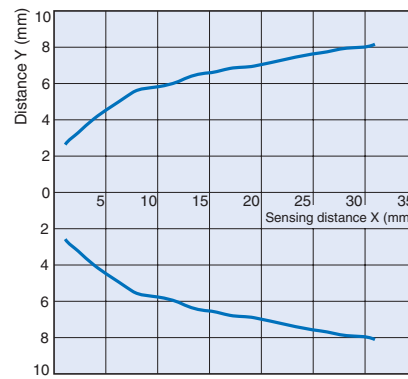

Inclination Characteristics

Convergent-reflective

E3T-SL1□ (Top to Bottom)

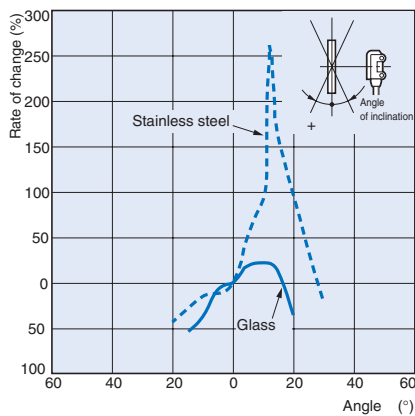

E3T-SL1□ (Right to Left)

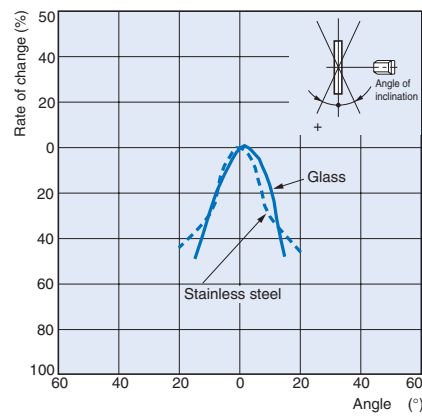

E3T-SL2□ (Top to Bottom)

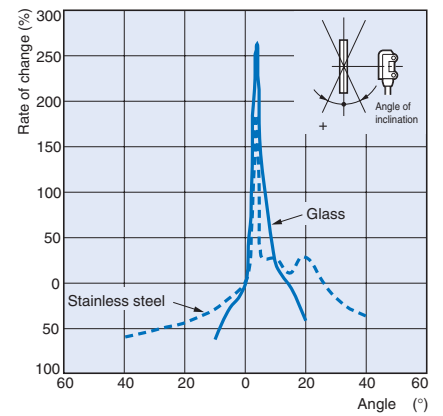

BGS Reflective

E3T-SL2□ (Right to Left)

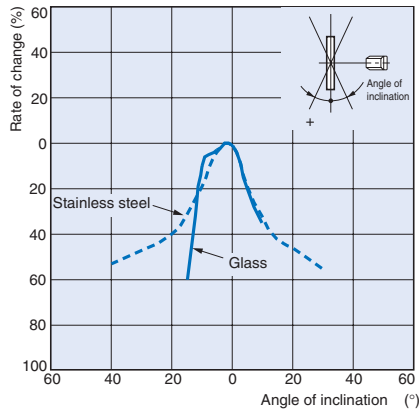

E3T-FL1□ (Top to Bottom)

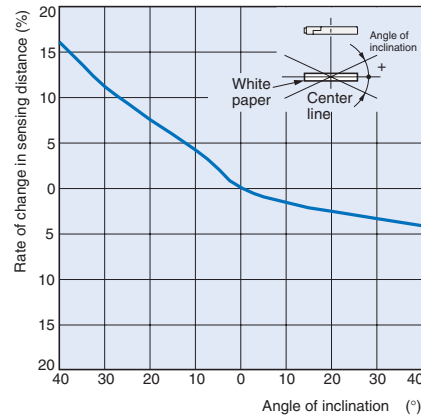

E3T-FL1□ (Right to Left)

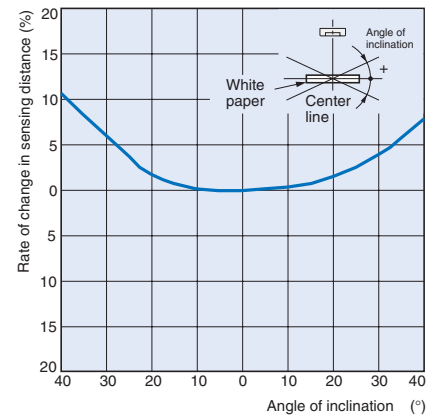

E3T-FL2□ (Top to Bottom)

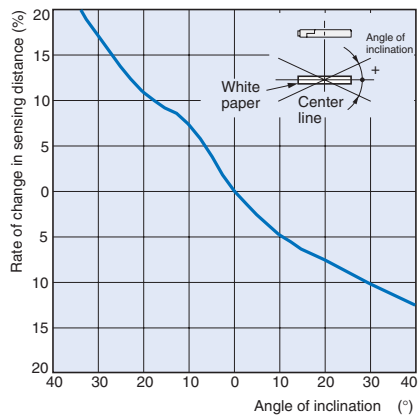

E3T-FL2□ (Right to Left)

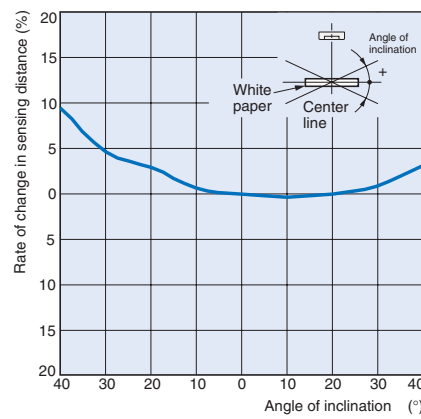

Excess Gain vs. Set Distance

Through-beam

E3T-ST1□

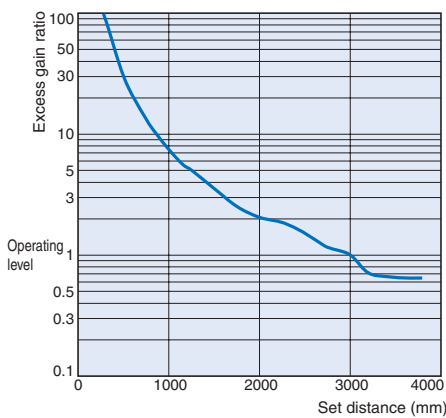

E3T-FT1□

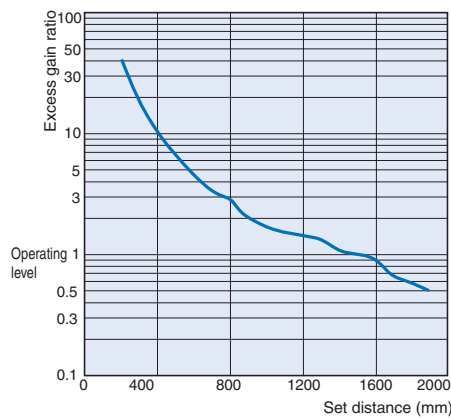

E3T-ST2□

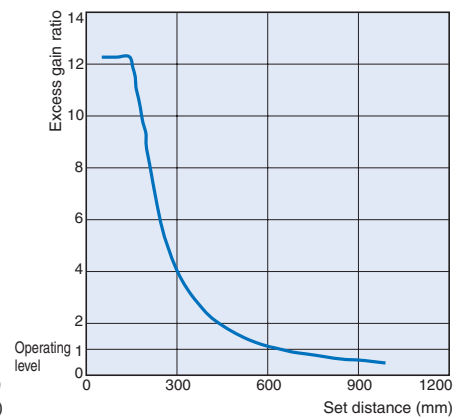

Retro-reflective

E3T-FT2□

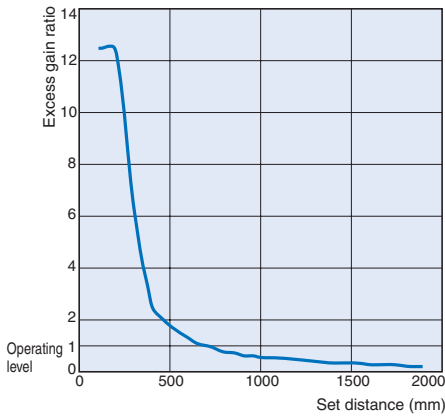

E3T-SR2□ + E39-R4 (Provided)

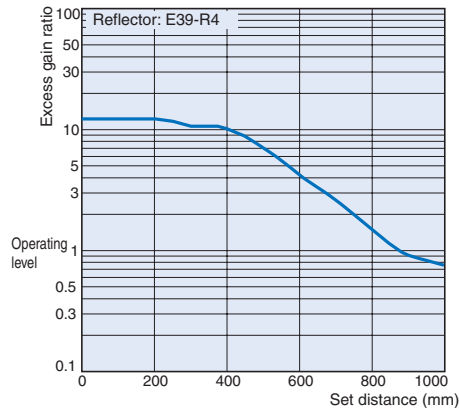

E3T-SR3□ + E39-R37 (Provided)

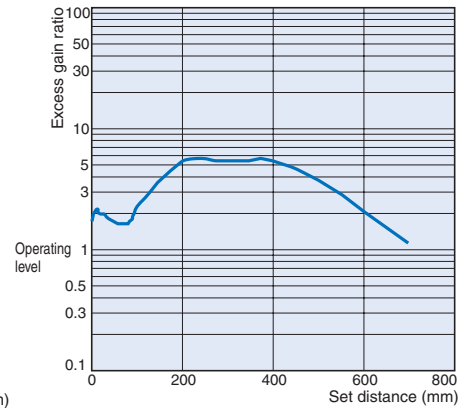

Diffuse-reflective

E3T-FD1□

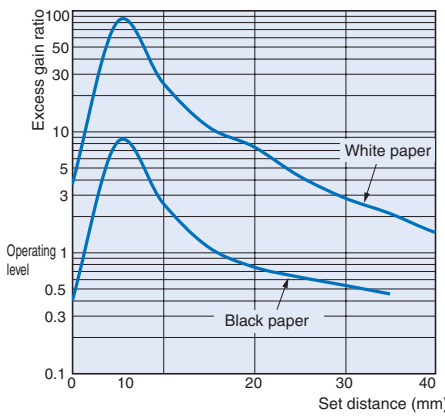

Convergent-reflective

E3T-SL1□

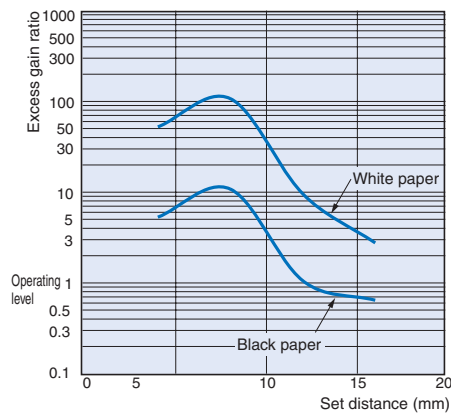

E3T-SL2□

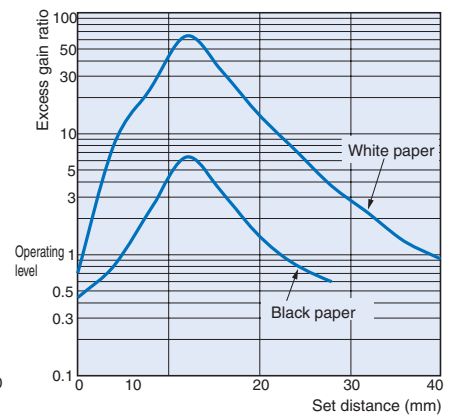

Sensing Object Size vs. Sensing Distance

E3T-SL1□

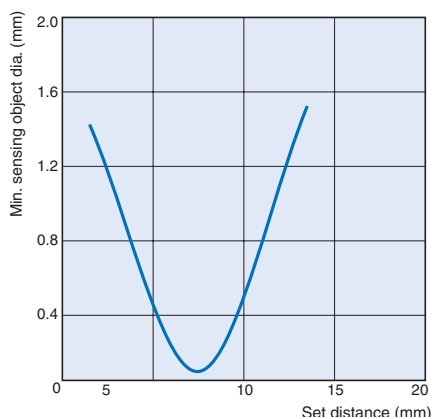

E3T-FD1□, E3T-SL2□

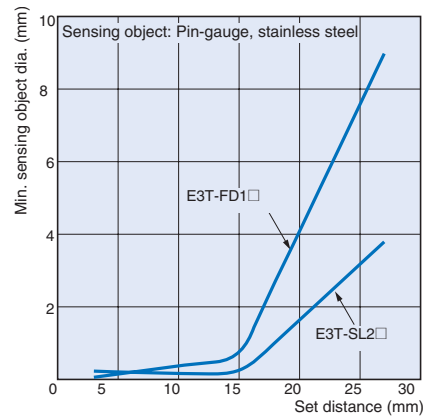

Sensing Distance vs. Material

Convergent-reflective

E3T-SL1 □

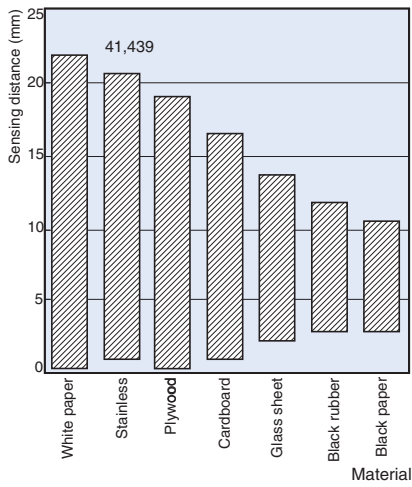

E3T-SL2 □

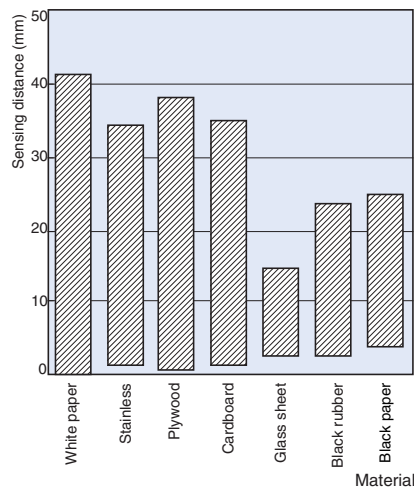

Diffuse-reflective

E3T-FD1 □

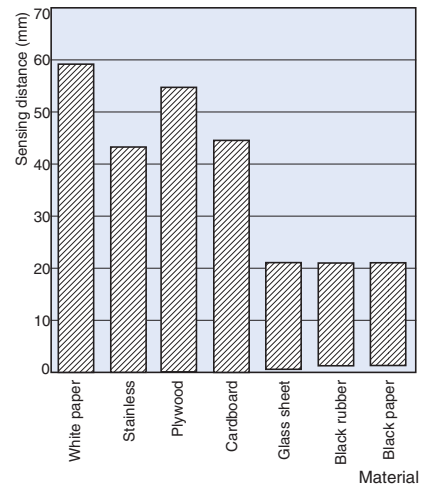

BGS Reflective

E3T-FL1 □

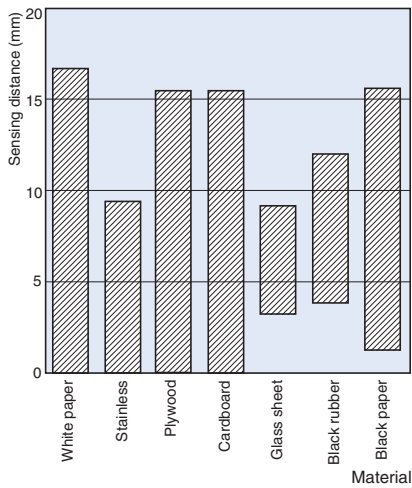

E3T-FL2 □

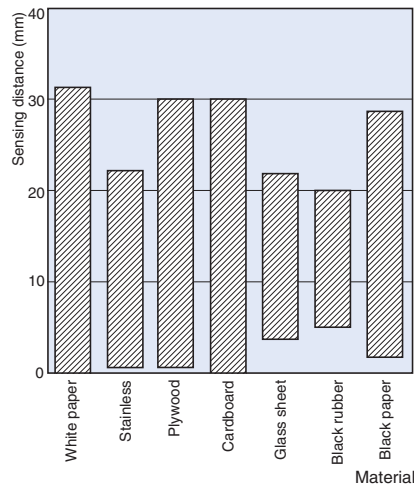

Sensing Distance Characteristics of Sensitivity Adjustment Unit (when Completing Optical Axial Adjustment)

E3T-ST1 □ + E39-E10 Sensitivity Adjustment Unit (Order Separately)

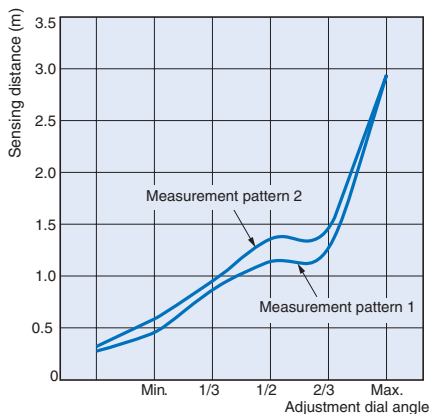

I/O Circuit Diagrams

NPN Output

Model	Operation mode	Timing charts	Output circuit
E3T-□□□1	Light-ON	<p>Light incident Light interrupted</p>	<p>Through-beam Receivers, Retroreflective and Reflective Models</p> <p>e-CON Connector Pin Arrangement</p> <p>Note: Pin 2 is not used. Pins 2 and 4 are not used with Through-beam Emitters.</p>
E3T-□□□2	Dark-ON	<p>Light incident Light interrupted</p>	<p>Through-beam Emitters</p> <p>e-CON Connector Pin Arrangement</p> <p>Note: Pin 2 is not used. Pins 2 and 4 are not used with Through-beam Emitters.</p>

PNP Output

Model	Operation mode	Timing charts	Output circuit
E3T-□□□3	Light-ON	<p>Light incident Light interrupted</p>	<p>Through-beam Receivers, Retroreflective and Reflective Models</p> <p>e-CON Connector Pin Arrangement</p> <p>Note: Pin 2 is not used. Pins 2 and 4 are not used with Through-beam Emitters.</p>
E3T-□□□4	Dark-ON	<p>Light incident Light interrupted</p>	<p>Through-beam Emitters</p> <p>e-CON Connector Pin Arrangement</p> <p>Note: Pin 2 is not used. Pins 2 and 4 are not used with Through-beam Emitters.</p>

Connectors

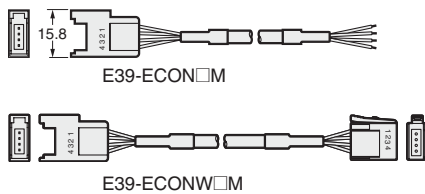

Classification	Wire color	Connector pin No.	Application
DC	Brown	1	Power supply (+V)
	White	2	---
	Brown	3	Power supply (0 V)
	White	4	Output

Note: Pin 2 is not used.

Safety Precautions

Warning

This product is not designed or rated for ensuring safety of persons. Do not use it for such purpose.



Do not apply AC power to the E3T, otherwise the E3T may rupture.



Precautions for Correct Use

Do not use the product in atmospheres or environment that exceed product ratings.

Wiring

The maximum power supply voltage is 24 VDC +10%. Before turning the power ON, make sure that the power supply voltage is not more than maximum voltage.

Load short-circuit protection

The E3T incorporates a load short-circuit protection function. If the load short-circuits, the output of the E3T will be turned OFF. Then, recheck the wiring and turn on the E3T again to reset the load short-circuit protection function. The load short-circuit protection function will work if there is a current flow that is 2.4 times larger than the rated load current. When using an inductance load, be sure that the inrush current will not exceed 2.4 times larger than the rated current.

Mounting

When mounting the Sensor, never strike it with a heavy object, such as a hammer. Doing so may reduce its watertight properties. Use M2 screws and flat or spring washers to secure the Sensor. (Tightening torque: 0.15 N·m max.)

Mounting the Sensor on Moving Parts

Consider models that use break resistant cables (e.g., Robotics Cables) if the Sensor will be mounted on a moving part, such as a robot hand. The flexing resistance of Robotics Cable at approximately 400 thousand times is far superior to that of standard cable at approximately 14 thousand times.

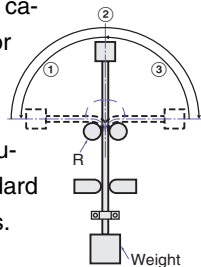

Cable Bending Rupture Test (Tough Cable Breaking Test)

The cable is repeatedly bent with power supplied to check the number of bends until the current is turned OFF

Specimen		Standard cable 2.4 mm dia. (7/ 0.127 mm dia.), 3 conductors	Robotics cable 2.4 mm (20/ 0.08 mm dia.), Test 3 conductors
Test	Bending angle (θ)	90° each to the left and right	
	Bending speed	50 times/min	
	Load	200 g	
	Operation per bend	Once in 1 to 3 in the diagram	
	Curvature radius of support point (R)	5 mm	
Result		Approx. 14,000 times	Approx. 400,000 times

Adjusting Indicators

- The following graphs indicate the status of each operating level.
- Be sure to use the E3T within the stable operating range.

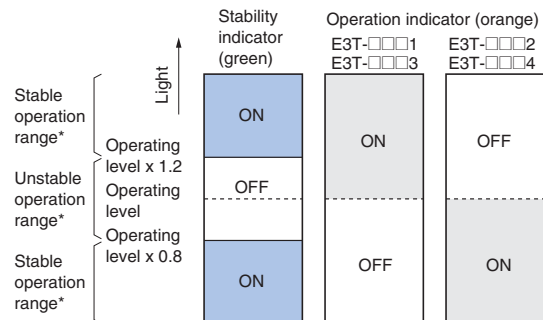

*If the E3T's operating level is set to the stable operation range, the E3T will be in most reliable operation without being influenced by temperature change, voltage fluctuation, dust, or setting change. If the operating level cannot be set to the stable operation range, pay attention to environmental changes while operating the E3T.

Use of E39-E10 Sensitivity Adjustment Unit (Dark-ON: E3T-ST12)

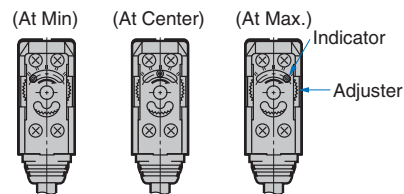

- Mount the Unit on the Receiver.
- Set the adjuster of the Sensitivity Adjustment Unit to Max. (Before shipping: Max.)
- After mounting on the Sensor, adjust the optical axis and secure the Sensor.
- Place a workpiece between the Emitter and Receiver and gradually turn the adjuster counterclockwise toward the Min. side. Stop turning the adjuster when the operation indicator and stability indicator (green) turn ON.
- Remove the workpiece and confirm that the operation indicator is OFF and the stability indicator (green) is ON. This completes the adjustment.

Note: If the light attenuation rate due to a workpiece is 40% or less, the stability indicator will not turn ON whether or not light is received. When the variation of light is small such as when sensing semi-transparent workpieces, carefully perform preliminary testing.

Others

Do not install the E3T in the following locations.

- Locations subject to excessive dust or dirt
- Locations subject to direct sunlight
- Locations subject to corrosive gas
- Locations subject to contact with organic solvents
- Locations subject to vibration and shock
- Locations subject to contact with water, oil, or chemicals
- Locations subject to high humidities that might result in condensation

Dimensions

Sensors

Through-beam Models
(Side-view)

E3T-ST1□ (Emitter)
E3T-ST2□ (Emitter)

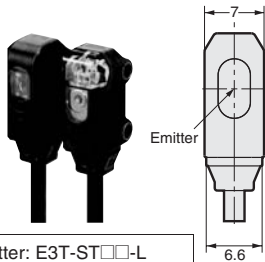

Emitter: E3T-ST□□-L
Receiver: E3T-ST□□-D

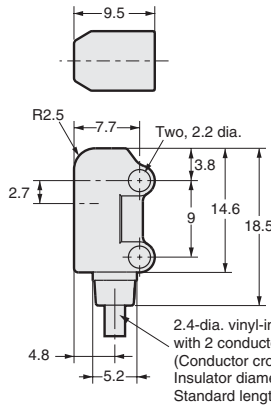

Mounting Holes

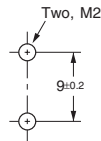

* Refer to *Mounting the Sensor on Moving Parts* on page 16 for details on Robotics Cable models.

e-CON Pre-wired Connector Model
(E3T-ST□□-ECON)

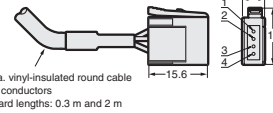

Terminal No.	Specifications
1	+V
2	---
3	0 V
4	---

E3T-ST1□ (Receiver)
E3T-ST2□ (Receiver)

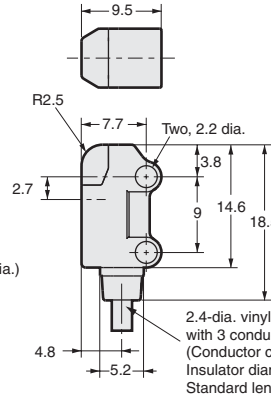
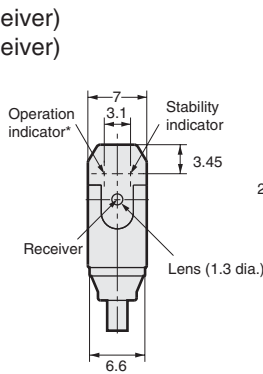

Mounting Holes

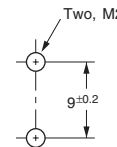

* Refer to *Mounting the Sensor on Moving Parts* on page 16 for details on Robotics Cable models.

e-CON Pre-wired Connector Model
(E3T-ST□□-ECON)

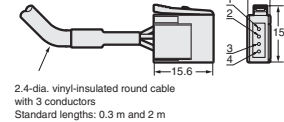

Terminal No.	Specifications
1	+V
2	---
3	0 V
4	Output

Through-beam Models (Flat)

E3T-FT1□ (Emitter)
E3T-FT2□ (Emitter)



Emitter: E3T-FT□□-L
Receiver: E3T-FT□□-D

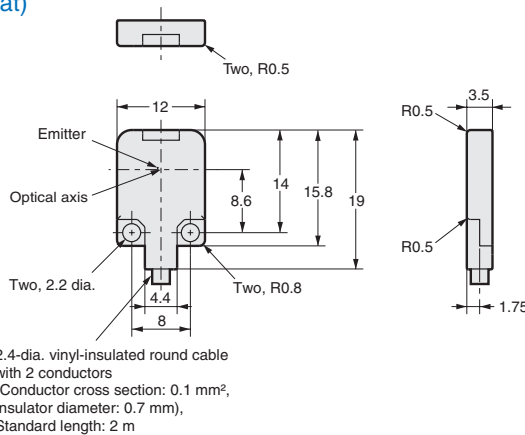

Mounting Holes

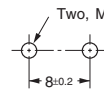

* Refer to *Mounting the Sensor on Moving Parts* on page 16 for details on Robotics Cable models.

e-CON Pre-wired Connector
(E3T-FT□□-ECON)

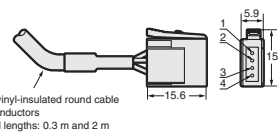

Terminal No.	Specifications
1	+V
2	---
3	0 V
4	---

E3T-FT1□ (Receiver)
E3T-FT2□ (Receiver)

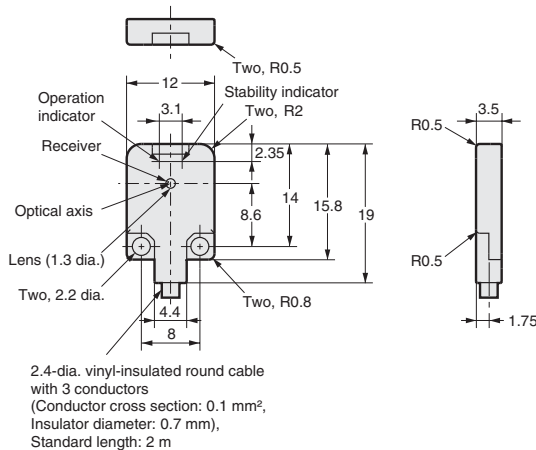

Mounting Holes

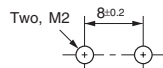

* Refer to *Mounting the Sensor on Moving Parts* on page 16 for details on Robotics Cable models.

e-CON Pre-wired Connector
(E3T-FT□□-ECON)

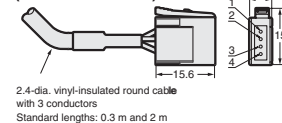

Terminal No.	Specifications
1	+V
2	---
3	0 V
4	Output

Retro-reflective Models (Side-view)

E3T-SR2□
E3T-SR3□

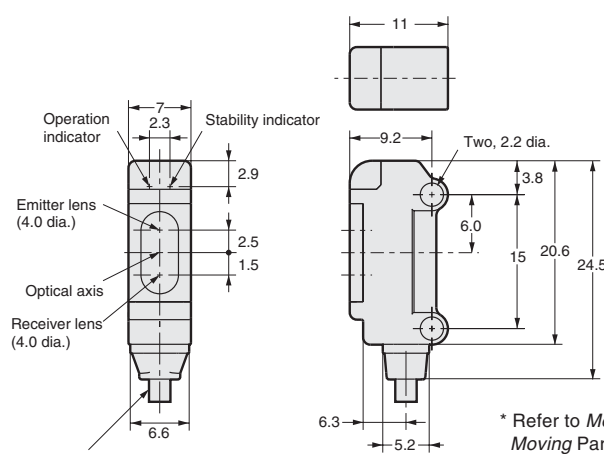

2.4-dia. vinyl-insulated round cable with 3 conductors (Conductor cross section: 0.1 mm², Insulator diameter: 0.7 mm), Standard length: 2 m

Mounting Holes

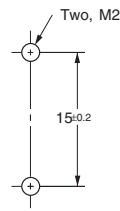

e-CON Pre-wired Connector (E3T-SR□□-ECON)

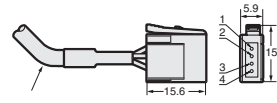

2.4-dia. vinyl-insulated round cable with 3 conductors Standard lengths: 0.3 m and 2 m

Terminal No.	Specifications
1	+V
2	---
3	0 V
4	Output

* Refer to *Mounting the Sensor on Moving Parts* on page 16 for details on Robotics Cable models.

Diffuse-reflective Models (Flat)

E3T-FD1□

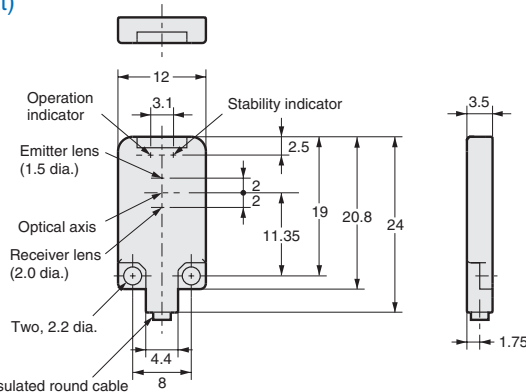

2.4-dia. vinyl-insulated round cable with 3 conductors (Conductor cross section: 0.1 mm², Insulator diameter: 0.7 mm), Standard length: 2 m

Mounting Holes

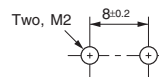

e-CON Pre-wired Connector (E3T-FD□□-ECON)

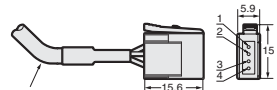

2.4-dia. vinyl-insulated round cable with 3 conductors Standard lengths: 0.3 m and 2 m

Terminal No.	Specifications
1	+V
2	---
3	0 V
4	Output

* Refer to *Mounting the Sensor on Moving Parts* on page 16 for details on Robotics Cable models.

Convergent-reflective Models (Side-view)

E3T-SL1□
E3T-SL2□

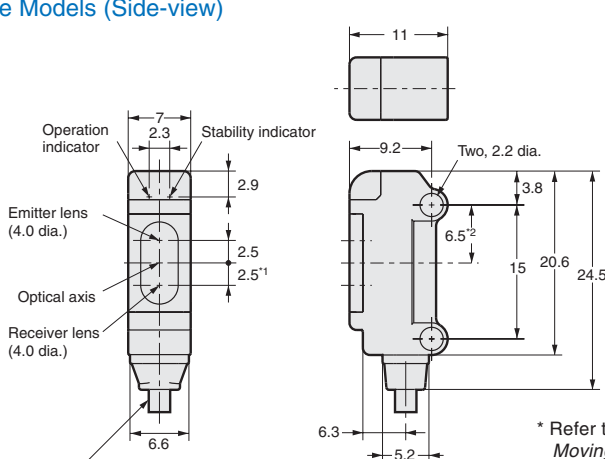

2.4-dia. vinyl-insulated round cable with 3 conductors (Conductor cross section: 0.1 mm², Insulator diameter: 0.7 mm), Standard length: 2 m

Mounting Holes

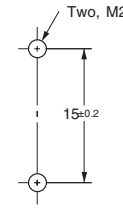

e-CON Pre-wired Connector (E3T-SL□□-ECON)

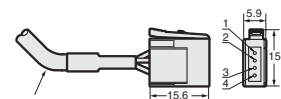

2.4-dia. vinyl-insulated round cable with 3 conductors Standard lengths: 0.3 m and 2 m

Terminal No.	Specifications
1	+V
2	---
3	0 V
4	Output

* Refer to *Mounting the Sensor on Moving Parts* on page 16 for details on Robotics Cable models.

BGS Models (Flat)

- E3T-FL1□
- E3T-FL2□

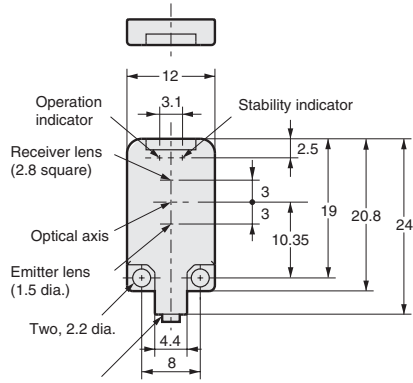

2.4-dia. vinyl-insulated round cable with 3 conductors (Conductor cross section: 0.1 mm², Insulator diameter: 0.7 mm), Standard length: 2 m

Mounting Holes

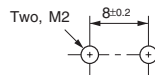

e-CON Pre-wired Connector (E3T-FL□□-ECON)

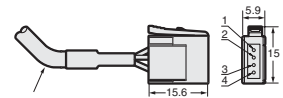

2.4-dia. vinyl-insulated round cable with 3 conductors
Standard lengths: 0.3 m and 2 m

Terminal No.	Specifications
1	+V
2	---
3	0 V
4	Output

* Refer to *Mounting the Sensor on Moving Parts* on page 16 for details on Robotics Cable models.

Accessories

Reflector (Provided with E3T-SR2□)

E39-R4



Material, reflective surface: acrylic
Rear surface: ABS

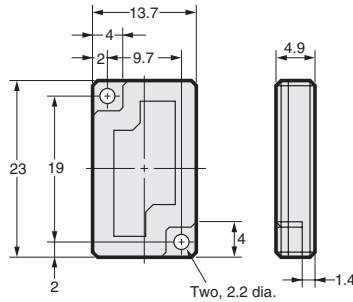

Reflector (Provided with E3T-SR3□)

E39-R37



Material: Mounting plate: stainless steel (SUS301)
Reflective surface: acrylic

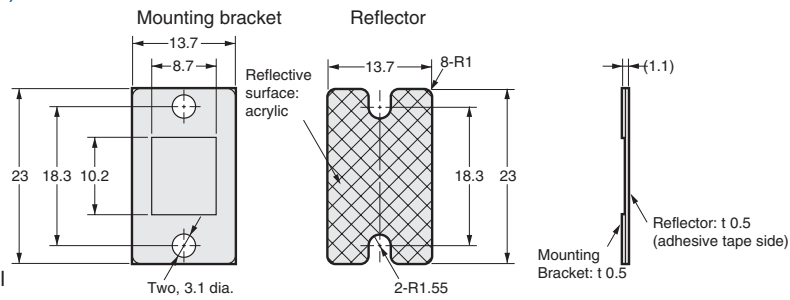

Note: The reflective plate and mounting plate (1) come as a set.

Accessories (Order Separately)

Slit for E3T-ST1□ Through-beam Models
E39-S63

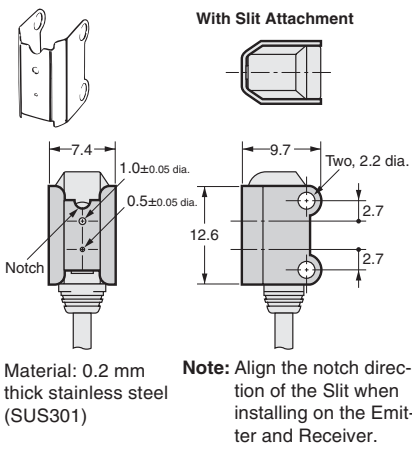

Slit for E3T-FT1□ Through-beam Models
E39-S64

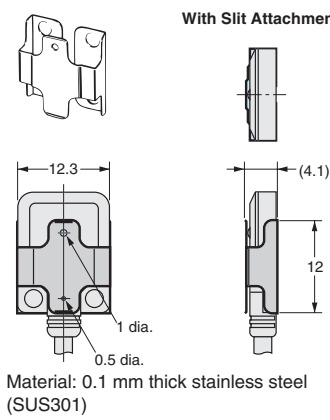

Sensitivity Adjustment Unit
(for E3T-ST1□ Through-beam Models)
E39-E10

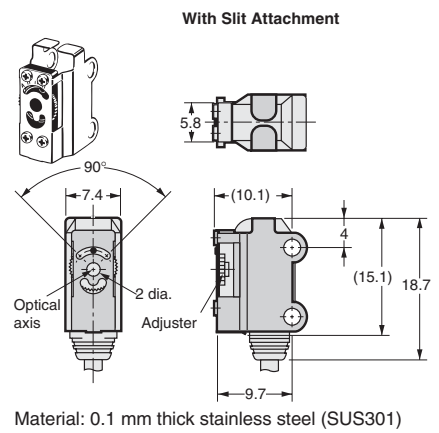

Mounting Brackets for Side-view Models

E39-L116

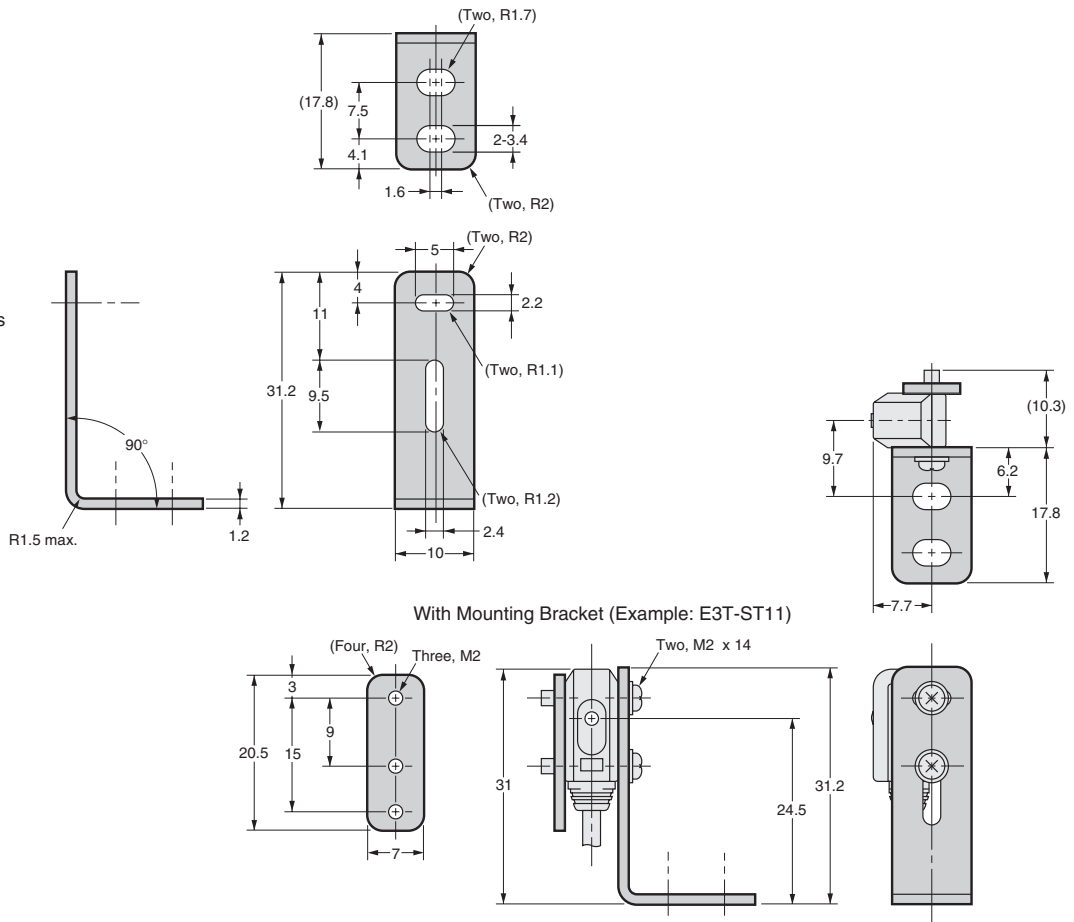

Mounting Brackets for Side-view Models

E39-L117



Material: 1.2 mm thick stainless steel (SUS304)

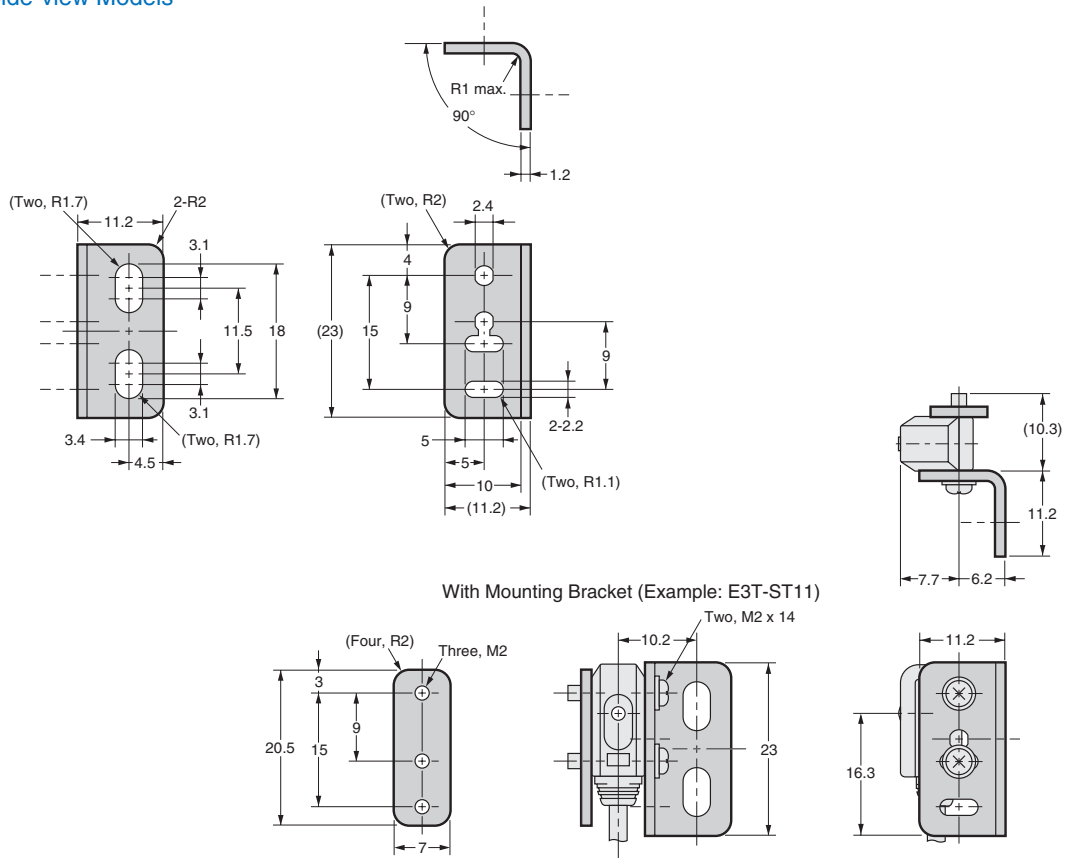

Mounting Brackets for Side-view Models

E39-L118



Material: 1.2 mm thick stainless steel (SUS304)

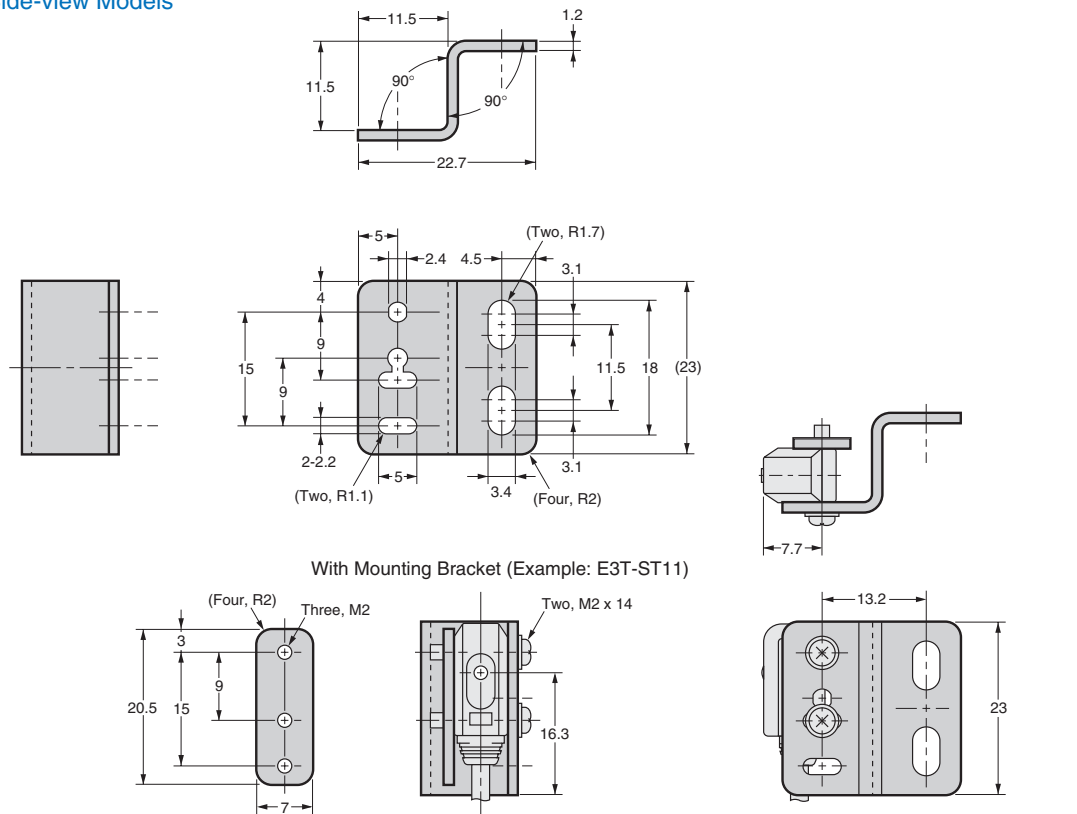

Mounting Brackets for Flat Models

E39-L119



Material: 1.2 mm thick stainless steel (SUS304)

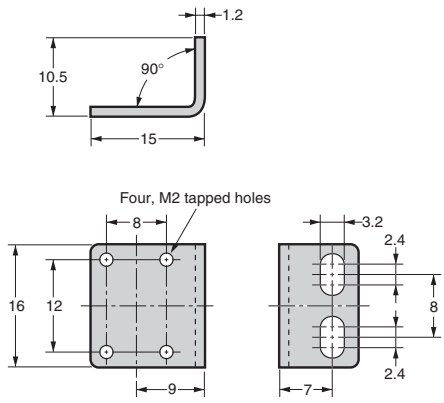

With Mounting Bracket
(Example: E3T-FT11)

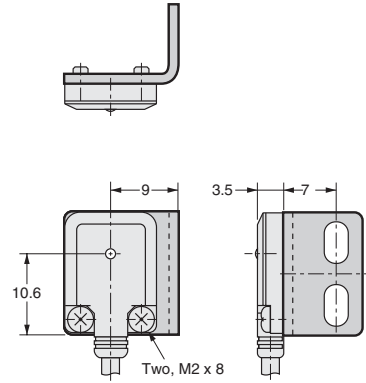

Mounting Brackets for Flat Models

E39-L120



Material: 1.2 mm thick stainless steel (SUS304)

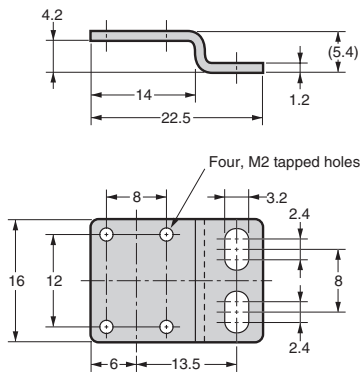

With Mounting Bracket
(Example: E3T-FT11)

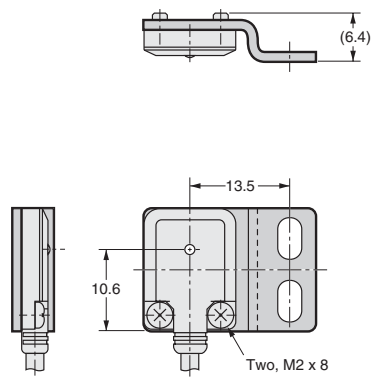

Terms and Conditions of Sale

1. **Offer; Acceptance.** These terms and conditions (these "Terms") are deemed part of all quotes, agreements, purchase orders, acknowledgments, price lists, catalogs, manuals, brochures and other documents, whether electronic or in writing, relating to the sale of products or services (collectively, the "Products") by Omron Electronics LLC and its subsidiary companies ("Omron"). Omron objects to any terms or conditions proposed in Buyer's purchase order or other documents which are inconsistent with, or in addition to, these Terms.
2. **Prices; Payment Terms.** All prices stated are current, subject to change without notice by Omron. Omron reserves the right to increase or decrease prices on any unshipped portions of outstanding orders. Payments for Products are due net 30 days unless otherwise stated in the invoice.
3. **Discounts.** Cash discounts, if any, will apply only on the net amount of invoices sent to Buyer after deducting transportation charges, taxes and duties, and will be allowed only if (i) the invoice is paid according to Omron's payment terms and (ii) Buyer has no past due amounts.
4. **Interest.** Omron, at its option, may charge Buyer 1-1/2% interest per month or the maximum legal rate, whichever is less, on any balance not paid within the stated terms.
5. **Orders.** Omron will accept no order less than \$200 net billing.
6. **Governmental Approvals.** Buyer shall be responsible for, and shall bear all costs involved in, obtaining any government approvals required for the importation or sale of the Products.
7. **Taxes.** All taxes, duties and other governmental charges (other than general real property and income taxes), including any interest or penalties thereon, imposed directly or indirectly on Omron or required to be collected directly or indirectly by Omron for the manufacture, production, sale, delivery, importation, consumption or use of the Products sold hereunder (including customs duties and sales, excise, use, turnover and license taxes) shall be charged to and remitted by Buyer to Omron.
8. **Financial.** If the financial position of Buyer at any time becomes unsatisfactory to Omron, Omron reserves the right to stop shipments or require satisfactory security or payment in advance. If Buyer fails to make payment or otherwise comply with these Terms or any related agreement, Omron may (without liability and in addition to other remedies) cancel any unshipped portion of Products sold hereunder and stop any Products in transit until Buyer pays all amounts, including amounts payable hereunder, whether or not then due, which are owing to it by Buyer. Buyer shall in any event remain liable for all unpaid accounts.
9. **Cancellation; Etc.** Orders are not subject to rescheduling or cancellation unless Buyer indemnifies Omron against all related costs or expenses.
10. **Force Majeure.** Omron shall not be liable for any delay or failure in delivery resulting from causes beyond its control, including earthquakes, fires, floods, strikes or other labor disputes, shortage of labor or materials, accidents to machinery, acts of sabotage, riots, delay in or lack of transportation or the requirements of any government authority.
11. **Shipping; Delivery.** Unless otherwise expressly agreed in writing by Omron:
 - a. Shipments shall be by a carrier selected by Omron; Omron will not drop ship except in "break down" situations.
 - b. Such carrier shall act as the agent of Buyer and delivery to such carrier shall constitute delivery to Buyer;
 - c. All sales and shipments of Products shall be FOB shipping point (unless otherwise stated in writing by Omron), at which point title and risk of loss shall pass from Omron to Buyer; provided that Omron shall retain a security interest in the Products until the full purchase price is paid;
 - d. Delivery and shipping dates are estimates only; and
 - e. Omron will package Products as it deems proper for protection against normal handling and extra charges apply to special conditions.
12. **Claims.** Any claim by Buyer against Omron for shortage or damage to the Products occurring before delivery to the carrier must be presented in writing to Omron within 30 days of receipt of shipment and include the original transportation bill signed by the carrier noting that the carrier received the Products from Omron in the condition claimed.
13. **Warranties.** (a) **Exclusive Warranty.** Omron's exclusive warranty is that the Products will be free from defects in materials and workmanship for a period of twelve months from the date of sale by Omron (or such other period expressed in writing by Omron). Omron disclaims all other warranties, express or implied. (b) **Limitations.** OMRON MAKES NO WARRANTY OR REPRESENTATION, EXPRESS OR IMPLIED, ABOUT NON-INFRINGEMENT, MERCHANTABILITY OR FITNESS FOR A PARTICULAR PURPOSE OF THE PRODUCTS. BUYER ACKNOWLEDGES THAT IT ALONE HAS DETERMINED THAT THE PRODUCTS WILL SUITABLY MEET THE REQUIREMENTS OF THEIR INTENDED USE. Omron further disclaims all warranties and responsibility of any type for claims or expenses based on infringement by the Products or otherwise of any intellectual property right. (c) **Buyer Remedy.** Omron's sole obligation hereunder shall be, at Omron's election, to (i) replace (in the form originally shipped with Buyer responsible for labor charges for removal or replacement thereof) the non-complying Product, (ii) repair the non-complying Product, or (iii) repay or credit Buyer an amount equal to the purchase price of the non-complying Product; provided that in no event shall Omron be responsible for warranty, repair, indemnity or any other claims or expenses regarding the Products unless Omron's analysis confirms that the Products were properly handled, stored, installed and maintained and not subject to contamination, abuse, misuse or inappropriate modification. Return of any Products by Buyer must be approved in writing by Omron before shipment. Omron Companies shall not be liable for the suitability or unsuitability or the results from the use of Products in combination with any electrical or electronic components, circuits, system assemblies or any other materials or substances or environments. Any advice, recommendations or information given orally or in writing, are not to be construed as an amendment or addition to the above warranty. See <http://oeweb.omron.com> or contact your Omron representative for published information.
14. **Limitation on Liability; Etc.** OMRON COMPANIES SHALL NOT BE LIABLE FOR SPECIAL, INDIRECT, INCIDENTAL, OR CONSEQUENTIAL DAMAGES, LOSS OF PROFITS OR PRODUCTION OR COMMERCIAL LOSS IN ANY WAY CONNECTED WITH THE PRODUCTS, WHETHER SUCH CLAIM IS BASED IN CONTRACT, WARRANTY, NEGLIGENCE OR STRICT LIABILITY. Further, in no event shall liability of Omron Companies exceed the individual price of the Product on which liability is asserted.
15. **Indemnities.** Buyer shall indemnify and hold harmless Omron Companies and their employees from and against all liabilities, losses, claims, costs and expenses (including attorney's fees and expenses) related to any claim, investigation, litigation or proceeding (whether or not Omron is a party) which arises or is alleged to arise from Buyer's acts or omissions under these Terms or in any way with respect to the Products. Without limiting the foregoing, Buyer (at its own expense) shall indemnify and hold harmless Omron and defend or settle any action brought against such Companies to the extent based on a claim that any Product made to Buyer specifications infringed intellectual property rights of another party.
16. **Property; Confidentiality.** Any intellectual property in the Products is the exclusive property of Omron Companies and Buyer shall not attempt to duplicate it in any way without the written permission of Omron. Notwithstanding any charges to Buyer for engineering or tooling, all engineering and tooling shall remain the exclusive property of Omron. All information and materials supplied by Omron to Buyer relating to the Products are confidential and proprietary, and Buyer shall limit distribution thereof to its trusted employees and strictly prevent disclosure to any third party.
17. **Export Controls.** Buyer shall comply with all applicable laws, regulations and licenses regarding (i) export of products or information; (ii) sale of products to "forbidden" or other proscribed persons; and (iii) disclosure to non-citizens of regulated technology or information.
18. **Miscellaneous.** (a) **Waiver.** No failure or delay by Omron in exercising any right and no course of dealing between Buyer and Omron shall operate as a waiver of rights by Omron. (b) **Assignment.** Buyer may not assign its rights hereunder without Omron's written consent. (c) **Law.** These Terms are governed by the law of the jurisdiction of the home office of the Omron company from which Buyer is purchasing the Products (without regard to conflict of law principles). (d) **Amendment.** These Terms constitute the entire agreement between Buyer and Omron relating to the Products, and no provision may be changed or waived unless in writing signed by the parties. (e) **Severability.** If any provision hereof is rendered ineffective or invalid, such provision shall not invalidate any other provision. (f) **Setoff.** Buyer shall have no right to set off any amounts against the amount owing in respect of this invoice. (g) **Definitions.** As used herein, "including" means "including without limitation"; and "Omron Companies" (or similar words) mean Omron Corporation and any direct or indirect subsidiary or affiliate thereof.

Certain Precautions on Specifications and Use

1. **Suitability of Use.** Omron Companies shall not be responsible for conformity with any standards, codes or regulations which apply to the combination of the Product in the Buyer's application or use of the Product. At Buyer's request, Omron will provide applicable third party certification documents identifying ratings and limitations of use which apply to the Product. This information by itself is not sufficient for a complete determination of the suitability of the Product in combination with the end product, machine, system, or other application or use. Buyer shall be solely responsible for determining appropriateness of the particular Product with respect to Buyer's application, product or system. Buyer shall take application responsibility in all cases but the following is a non-exhaustive list of applications for which particular attention must be given: (i) Outdoor use, uses involving potential chemical contamination or electrical interference, or conditions or uses not described in this document. (ii) Use in consumer products or any use in significant quantities. (iii) Energy control systems, combustion systems, railroad systems, aviation systems, medical equipment, amusement machines, vehicles, safety equipment, and installations subject to separate industry or government regulations. (iv) Systems, machines and equipment that could present a risk to life or property. Please know and observe all prohibitions of use applicable to this Product. NEVER USE THE PRODUCT FOR AN APPLICATION INVOLVING SERIOUS RISK TO LIFE OR PROPERTY OR IN LARGE QUANTITIES WITHOUT ENSURING THAT THE SYSTEM AS A WHOLE HAS BEEN DESIGNED TO ADDRESS THE RISKS, AND THAT THE OMRON'S PRODUCT IS PROPERLY RATED AND INSTALLED FOR THE INTENDED USE WITHIN THE OVERALL EQUIPMENT OR SYSTEM.
2. **Programmable Products.** Omron Companies shall not be responsible for the user's programming of a programmable Product, or any consequence thereof.
3. **Performance Data.** Data presented in Omron Company websites, catalogs and other materials is provided as a guide for the user in determining suitability and does not constitute a warranty. It may represent the result of Omron's test conditions, and the user must correlate it to actual application requirements. Actual performance is subject to the Omron's Warranty and Limitations of Liability.
4. **Change in Specifications.** Product specifications and accessories may be changed at any time based on improvements and other reasons. It is our practice to change part numbers when published ratings or features are changed, or when significant construction changes are made. However, some specifications of the Product may be changed without any notice. When in doubt, special part numbers may be assigned to fix or establish key specifications for your application. Please consult with your Omron's representative at any time to confirm actual specifications of purchased Product.
5. **Errors and Omissions.** Information presented by Omron Companies has been checked and is believed to be accurate; however, no responsibility is assumed for clerical, typographical or proofreading errors or omissions.



OMRON ELECTRONICS LLC

1 Commerce Drive
Schaumburg, IL 60173
847.843.7900
For US technical support or
other inquiries: 800.556.6766

OMRON CANADA, INC.

885 Milner Avenue
Toronto, Ontario M1B 5V8
416.286.6465

OMRON ON-LINE

Global - <http://www.omron.com>
USA - <http://www.omron.com/oei>
Canada - <http://www.omron.ca>

UNITED STATES

To locate a Regional Sales Office, local Distributor or
to obtain product information, call: 847.843.7900

CANADA REGIONAL SALES OFFICES

Ontario	Toronto	416.286.6465
	Kitchener	519.896.1144
	Kingston	613.376.3968
Quebec	Montreal	514.636.6676
British Columbia	Vancouver	604.522.8855
Alberta	Edmonton	403.440.0818
	Calgary	403.257.3095

BRAZIL SALES OFFICE

Sao Paulo 55.11.5564.6488

ARGENTINA SALES OFFICE

Cono Sur 54.114.787.1129

MEXICO SALES OFFICES

Florida 954.227.2121 **Ciudad Juarez** 656.623.7083
Mexico, D.F. 555.534.1195 **Monterrey, N.L.** 818.377.4281