

PLEASE CHECK WWW.MOLEX.COM FOR LATEST PART INFORMATION

Part Number: [0687830017](#)
Status: **Active**
Overview: [displayport](#)
Description: DisplayPort*-to-DisplayPort* Cable Assembly, with Latches, 15.0m (49.21') Length, 26AWG, Low Bit Rate version

Documents:

[Drawing \(PDF\)](#) [RoHS Certificate of Compliance \(PDF\)](#)

General

Product Family	Cable Assemblies
Series	68783
Connector to Connector	DisplayPort* Both Ends
Overview	displayport
Product Name	DisplayPort*

Physical

Cable Length	15.0m (49.21')
Circuits (Loaded)	20
Color - Resin	Black
Gender	Male-Male
Lock to Mating Part	Yes
Material - Metal	Brass, Stainless Steel
Material - Plating Mating	Gold
Material - Plating Termination	Tin
Material - Resin	ABS Alloy, High Temperature Thermoplastic
Packaging Type	Bag
Pitch - Mating Interface (in)	0.039 In
Pitch - Mating Interface (mm)	1.00 mm
Plating min: Mating (µin)	32
Plating min: Mating (µm)	0.8
Plating min: Termination (µin)	80
Plating min: Termination (µm)	2
Single Ended	No
Termination Interface: Style	Surface Mount
Waterproof / Dustproof	No
Wire Insulation Diameter	N/A
Wire Size AWG	26
Wire/Cable Type	Round

Electrical

Current - Maximum per Contact	0.5A
Impedance	100 ohms
Shield Type	Full Shield
Shielded	Yes
Voltage - Maximum	40V

Material Info

Reference - Drawing Numbers

Sales Drawing	SD-68783-017
---------------	--------------

*DisplayPort is a Trademark of VESA



EU RoHS

**ELV and RoHS
Compliant**
**REACH SVHC
Not Reviewed**
**Halogen-Free
Status**

China RoHS



**Need more information on product
environmental compliance?**

Email productcompliance@molex.com
 For a multiple part number RoHS Certificate of Compliance, [click here](#)

Please visit the [Contact Us](#) section for any non-product compliance questions.

Search Parts in this Series

[68783Series](#)

Mates With

[47272 DisplayPort* Receptacles](#)

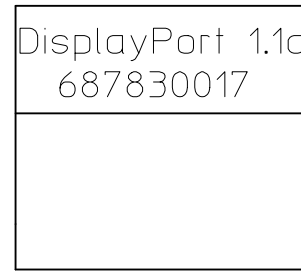
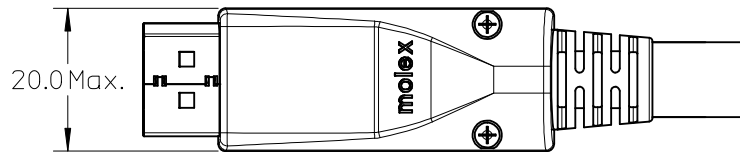
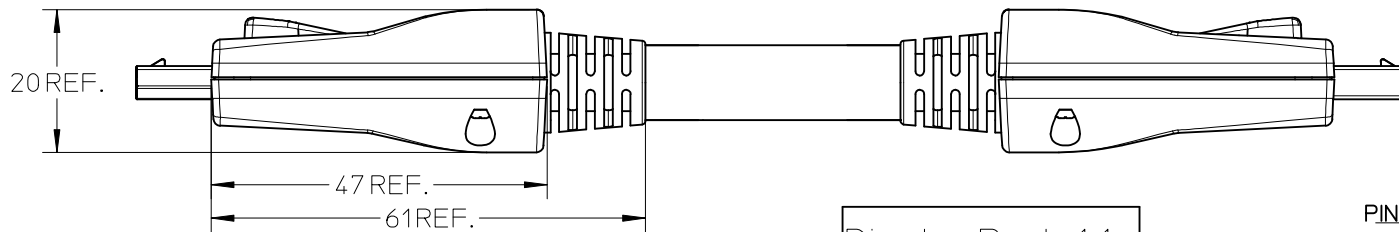
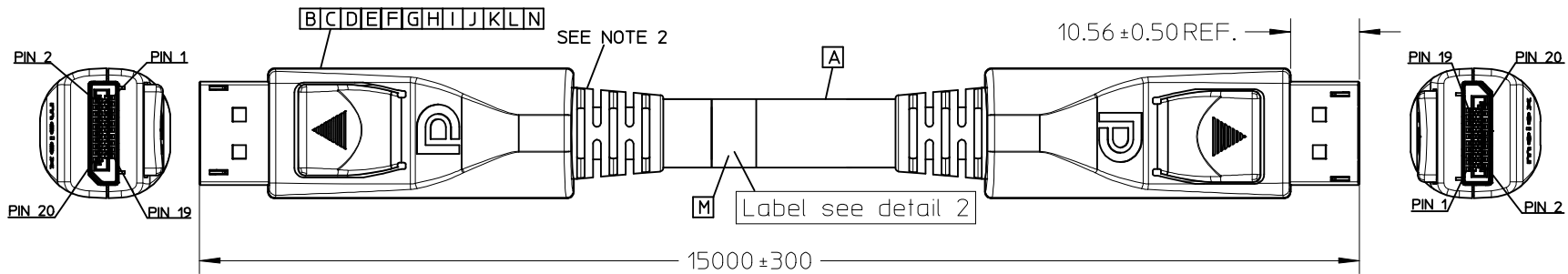

DETAIL 2

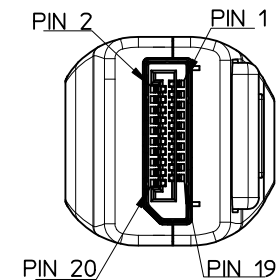

DETAIL PINOUT

ENTER DESCRIPTION EC NO: DG2009-0084 DRWN:ZYWANG01 2008/11/27 CHKD:BENTZ,LIU 2008/11/27 APPR:BLAU 2008/11/28	QUALITY SYMBOLS =0 =0	GENERAL TOLERANCES (UNLESS SPECIFIED)		DIMENSION STYLE MM ONLY	SCALE 1:1	DESIGN UNITS METRIC	THIRD ANGLE PROJECTION		
				DRAWN BY DATE ZYWANG01 2008-11-26	TITLE DISPLAYPORT 26AWG 15M LBR CABLE ASSY				
				CHECKED BY DATE BENTZ,LIU 2008-11-26					
				APPROVED BY DATE BENTZ,LIU 2008-11-26					
				MATERIAL NO. 687830017	MOLEX INCORPORATED		DOCUMENT NO. SD-68783-017	SHEET NO. 1 OF 2	
REV A	DESCRIPTION DRAFT WHERE APPLICABLE MUST REMAIN WITHIN DIMENSIONS	ANGULAR ±1/2°		THIS DRAWING CONTAINS INFORMATION THAT IS PROPRIETARY TO MOLEX INCORPORATED AND SHOULD NOT BE USED WITHOUT WRITTEN PERMISSION					





WIRE DIAGRAM:

SHELL		OVERALL BRAID	SHELL	
PIN 20	DP_PWR	N/A	PIN 20	DP_PWR
PIN 19	PwR_Rtn	ORANGE	PIN 19	PwR_Rtn
PIN 18	HPD	YELLOW	PIN 18	HPD
PIN 17	Aux(n)	WHITE	PIN 17	Aux(n)
PIN 16	GND	GND	PIN 16	GND
PIN 15	Aux(p)	WHITE	PIN 15	Aux(p)
PIN 14	GND	RED	PIN 14	GND
PIN 13	GND	BROWN	PIN 13	GND
PIN 12	ML3(n)	WHITE	PIN 1	ML3(n)
PIN 8	GND	DRAIN	PIN 5	GND
PIN 10	ML3(p)	WHITE	PIN 3	ML3(p)
PIN 9	ML2(n)	WHITE	PIN 4	ML2(n)
PIN 11	GND	DRAIN	PIN 2	GND
PIN 7	ML2(p)	WHITE	PIN 6	ML2(p)
PIN 6	ML1(n)	WHITE	PIN 7	ML1(n)
PIN 2	GND	DRAIN	PIN 11	GND
PIN 4	ML1(p)	WHITE	PIN 9	ML1(p)
PIN 3	ML0(n)	WHITE	PIN 10	ML0(n)
PIN 5	GND	DRAIN	PIN 8	GND
PIN 1	ML0(p)	WHITE	PIN 12	ML0(p)
P1	FUNCTION	COLOR	P2	FUNCTION

NOTE:

1. THE COMPONENT MUST MEET ROHS REQUIREMENT.
2. THE ELECTRIC MUST MEET DP SPEC. LOW BIT RATE REQUIREMENT.

N	Copper-ring		2
M	Label		1
L	Add hot melt glue		
K	COPPER FOIL		2
J	SCREW M2*6.5		4
I	PCB		2
H	COVER-UP(with Latch)		2
G	COVER-DOWN		2
F	LATCH 1		2
E	LATCH 2		2
D	INNER-SHELL-LOWER		2
C	INNER-SHELL-UPPER		2
B	PLUG SUB-ASS'Y CONN.		2
A	DisplayPart AWG26 Twinax cable	15000MM	1
ITEM	DESCRIPTION	LENGTH	QTY.

ENTER DESCRIPTION EC NO: DG2009-0084 DRWN:ZYWANG01 2008/11/27 CHKD: 2008/11/27 APPR:BLAU 2008/11/28	QUALITY SYMBOLS  =0  =0	GENERAL TOLERANCES (UNLESS SPECIFIED)		DIMENSION STYLE MM ONLY		SCALE	DESIGN UNITS METRIC	 THIRD ANGLE PROJECTION	
				DRAWN BY DATE ZYWANG01 2008-11-26	TITLE DISPLAYPORT 26AWG 15M LBR CABLE ASSY				
				CHECKED BY DATE BENTZ,LIU 2008-11-26					
				APPROVED BY DATE BENTZ,LIU 2008-11-26					
		ANGULAR ±1/2°		MATERIAL NO. 687830017		DOCUMENT NO. SD-68783-017		SHEET NO. 2 OF 2	
REV A		DRAFT WHERE APPLICABLE MUST REMAIN WITHIN DIMENSIONS		SIZE  4		THIS DRAWING CONTAINS INFORMATION THAT IS PROPRIETARY TO MOLEX INCORPORATED AND SHOULD NOT BE USED WITHOUT WRITTEN PERMISSION			