

PLEASE CHECK WWW.MOLEX.COM FOR LATEST PART INFORMATION

Part Number: [0459844182](#)
Status: **Active**
Overview: [extreme_lphpower](#)
Description: 1.27mm (.050"), 12.00mm (.472") Pitch, EXTreme LPHPower™ Receptacle Header, Right Angle, 4 Power Contacts, 40 Signal Contacts, Select Gold (Au) Plating, for 2.36mm (.093") Thick PC Board

Documents:

[3D Model](#) [Product Specification PS-45984-001 \(PDF\)](#)
[Drawing \(PDF\)](#) [RoHS Certificate of Compliance \(PDF\)](#)

Agency Certification

CSA LR19980
 UL E29179

General

Product Family PCB Receptacles
 Series [45984](#)
 Application Board-to-Board
 Overview [extreme_lphpower](#)
 Product Name EXTreme LPHPower™

Physical

Circuits (Loaded) 44
 Circuits (maximum) 44
 Circuits Detail 4 Power, 40 Signal
 Color - Resin Black
 Durability (mating cycles max) 250
 Flammability 94V-0
 Glow-Wire Compliant No
 Guide to Mating Part No
 Keying to Mating Part Yes
 Lock to Mating Part No
 Material - Metal High Performance Alloy (HPA), Phosphor Bronze
 Material - Plating Mating Gold
 Material - Plating Termination Tin
 Material - Resin High Temperature Thermoplastic
 Number of Rows 2
 Orientation Right Angle
 PC Tail Length (in) 0.142 In
 PC Tail Length (mm) 3.60 mm
 PCB Locator No
 PCB Retention None
 PCB Thickness Recommended (in) 0.093 In
 PCB Thickness Recommended (mm) 2.36 mm
 Packaging Type Tray
 Pitch - Mating Interface (in) 0.050 In, 0.472 In
 Pitch - Mating Interface (mm) 1.27 mm, 12.00 mm
 Plating min: Mating (µin) 30
 Plating min: Mating (µm) 0.75
 Plating min: Termination (µin) 150, 75
 Plating min: Termination (µm) 1.875, 3.75
 Polarized to Mating Part Yes
 Polarized to PCB Yes
 Stackable No
 Surface Mount Compatible (SMC) Yes

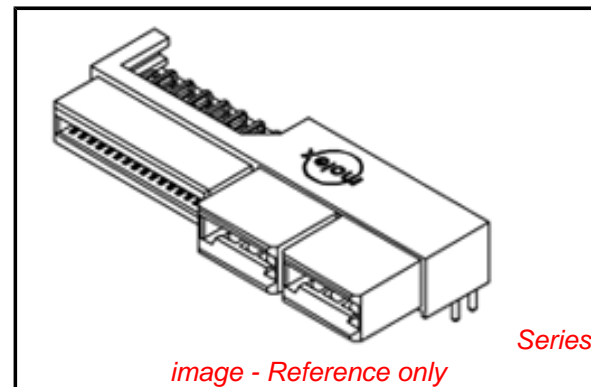

EU RoHS

ELV and RoHS Compliant
REACH SVHC Contains SVHC: No
Halogen-Free Status

China RoHS



Need more information on product environmental compliance?

Email productcompliance@molex.com
 For a multiple part number RoHS Certificate of Compliance, [click here](#)

Please visit the [Contact Us](#) section for any non-product compliance questions.

Search Parts in this Series

[45984Series](#)

Mates With

[45985](#) EXTreme LPHPower™ Headers, 1.57mm (.062") Card Edge

Temperature Range - Operating	-40°C to +105°C
Termination Interface: Style	Through Hole

Electrical

Current - Maximum per Contact	30A
Grounding to PCB	No
Voltage - Maximum	250V AC (RMS)/DC

Solder Process Data

Duration at Max. Process Temperature (seconds)	20
Lead-free Process Capability	Wave Capable (TH only)
Max. Cycles at Max. Process Temperature	3
Process Temperature max. C	260

Material Info

Reference - Drawing Numbers

Packaging Specification	PK-45984-001
Product Specification	PS-45984-001
Sales Drawing	SD-45984-400

This document was generated on 05/21/2010

PLEASE CHECK WWW.MOLEX.COM FOR LATEST PART INFORMATION

6

5

4

3

2

1

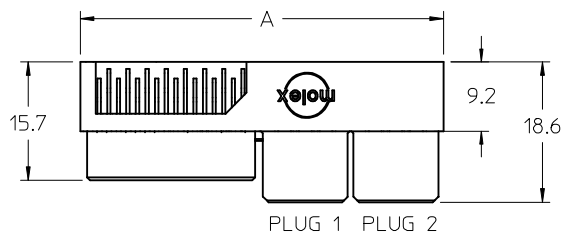

NOTES:

1. MATERIAL HOUSING: LCP, 94V-0, COLOR-BLACK.
CONTACT: COPPER ALLOY.
2. FINISH: SELECT GOLD - .76 μM /30 MI MIN. CONTACT AREA.
SELECT TIN - 3.81 μM /150 MI MIN. TAIL AREA.
BOTH OVER NICKEL - 1.27 μM /50 MI MIN.
3. POWER TERMINALS ARE LUBRICATED IN CONTACT AREA.
3. PRODUCT SPECIFICATION: PS-45984-001.
4. PACKAGING: TRAY PER PK-45984-001.
5. SEE SHEET 5 FOR CKT IDENTIFICATION.
6. PARTS ARE RoHS COMPLIANT.
7. PEG HOLES ARE OPTIONAL SEE SHEET 3 AND 4.
8. MATES TO 1577.062 CARD EDGE OR MOLEX P/N 45985-4***.

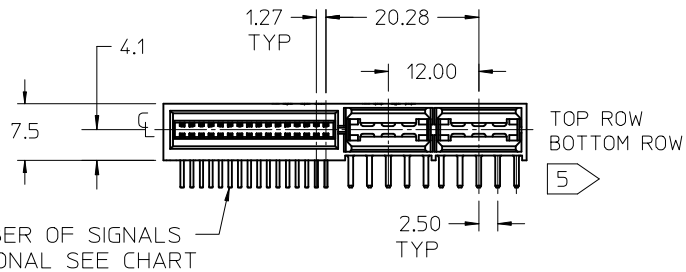

NUMBER OF SIGNALS
OPTIONAL SEE CHART

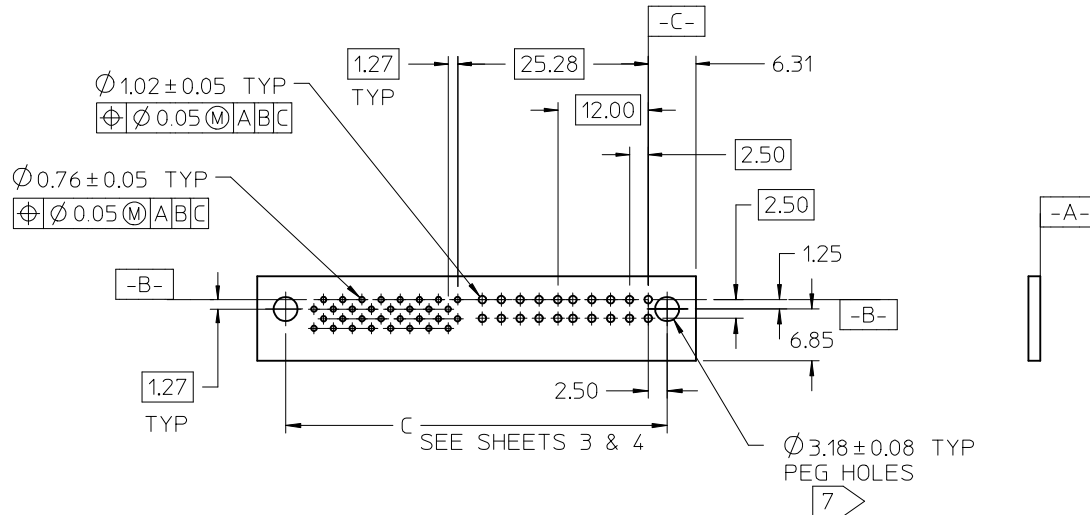
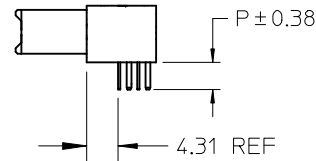

RECOMMENDED PCB LAYOUT: COMPONENT SIDE
PEG HOLES OPTIONAL

NO OF SIGNAL	MATERIAL NUMBER	DIM A REF	DIM P	PCB THK
12	45984-4111	35.5	4.50	3.18
16	45984-4121	38.0		
20	45984-4131	40.6		
24	45984-4141	43.1		
28	45984-4151	45.6		
32	45984-4161	48.2	3.60	2.36
36	45984-4171	50.7		
40	45984-4181	53.3		
12	45984-4112	35.5		
16	45984-4122	38.0		
20	45984-4132	40.6	2.90	1.57
24	45984-4142	43.1		
28	45984-4152	45.6		
32	45984-4162	48.2		
36	45984-4172	50.7		
40	45984-4182	53.3	2.90	1.57
12	45984-4113	35.5		
16	45984-4123	38.0		
20	45984-4133	40.6		
24	45984-4143	43.1		
28	45984-4153	45.6		
32	45984-4163	48.2		
36	45984-4173	50.7		
40	45984-4183	53.3		

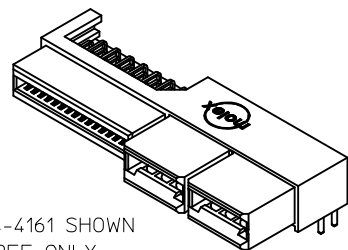

45984-4161 SHOWN
FOR REF ONLY
SEE CHART

REVISED	DESCRIPTION
EC NO: UCP2009-0971 DRWN:MBANDURA CHKD: APPR:APATEL	2008/11/13 2008/11/14 2008/11/17
REV	

	GENERAL TOLERANCES (UNLESS SPECIFIED)	
	mm	INCH
4 PLACES	± ---	± ---
3 PLACES	± ---	± ---
2 PLACES	± 0.25	± ---
1 PLACE	± ---	± ---
ANGULAR ± 1/2°		
DRAFT WHERE APPLICABLE MUST REMAIN WITHIN DIMENSIONS		

DIMENSION STYLE MM ONLY	
DRAWN BY	DATE
SAMIEC	2005/05/13
CHECKED BY	DATE
SAMIEC	2005/05/13
APPROVED BY	DATE
MARGULIS	2005/05/13
MATERIAL NO.	
SIZE	
A	

SCALE	DESIGN UNITS	THIRD ANGLE PROJECTION
1:1	METRIC	
TITLE		
LPH RECEPTACLE ASSEMBLY RT ANGLE 4 CIRCUIT POWER CONNECTOR		
molex MOLEX INCORPORATED		
DOCUMENT NO.	SHEET NO.	
SD-45984-400	1 OF 5	

NO OF SIGNAL	MATERIAL NUMBER	DIM A	DIM P	PCB THK
12	45984-4211	35.5	4.50	3.18
16	45984-4221	38.0		
20	45984-4231	40.6		
24	45984-4241	43.1		
28	45984-4251	45.6		
32	45984-4261	48.2	3.60	2.36
36	45984-4271	50.7		
40	45984-4281	53.3		
12	45984-4212	35.5		
16	45984-4222	38.0		
20	45984-4232	40.6	2.90	1.57
24	45984-4242	43.1		
28	45984-4252	45.6		
32	45984-4262	48.2		
36	45984-4272	50.7		
40	45984-4282	53.3	2.90	1.57
12	45984-4213	35.5		
16	45984-4223	38.0		
20	45984-4233	40.6		
24	45984-4243	43.1		
28	45984-4253	45.6		
32	45984-4263	48.2		
36	45984-4273	50.7		
40	45984-4283	53.3		

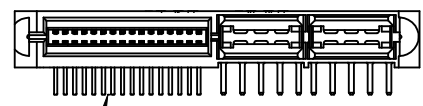
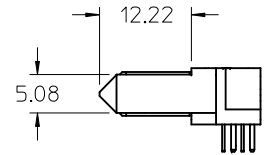
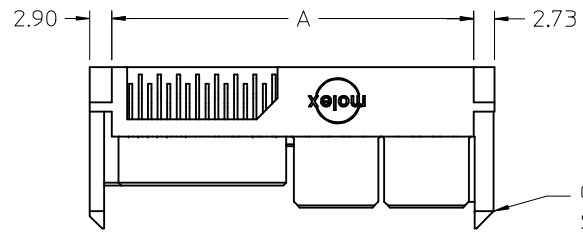

GUIDE POST OPTIONS

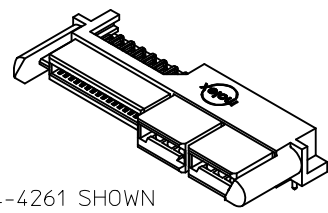

45984-4261 SHOWN FOR REF ONLY SEE CHART

REVISED	DESCRIPTION
EC NO: UCP2009-0971	
DRWN:MBANDURA 2008/11/13	
CHKD: 2008/11/14	
APPR:APATEL 2008/11/17	
REV	

GENERAL TOLERANCES (UNLESS SPECIFIED)	
	mm INCH
4 PLACES	± --- ± ---
3 PLACES	± --- ± ---
2 PLACES	± 0.25 ± ---
1 PLACE	± --- ± ---
ANGULAR ±1/2°	
DRAFT WHERE APPLICABLE MUST REMAIN WITHIN DIMENSIONS	

DIMENSION STYLE	
MM ONLY	
DRAWN BY	DATE
SAMIEC	2005/05/13
CHECKED BY	DATE
SAMIEC	2005/05/13
APPROVED BY	DATE
MARGULIS	2005/05/13
MATERIAL NO.	
SIZE	
A	

SCALE	DESIGN UNITS	THIRD ANGLE PROJECTION	
1:1	METRIC		
TITLE			
LPH RECEPTACLE ASSEMBLY RT ANGLE 4 CIRCUIT POWER CONNECTOR			
MOLEX INCORPORATED			
DOCUMENT NO.		SHEET NO.	
SD-45984-400		2 OF 5	
THIS DRAWING CONTAINS INFORMATION THAT IS PROPRIETARY TO MOLEX INCORPORATED AND SHOULD NOT BE USED WITHOUT WRITTEN PERMISSION			

6

5

4

3

2

1

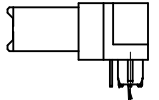
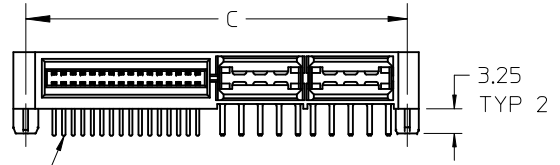
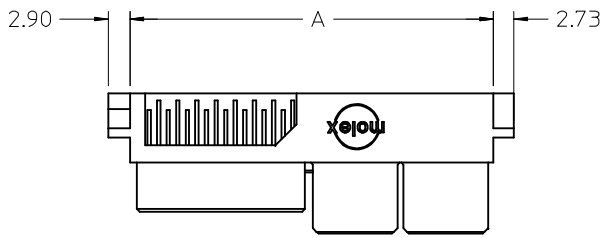

NO OF SIGNALS
OPTIONAL
SEE CHART

OPTIONAL PEGS

MOUNTING PEG OPTIONS

NO OF SIGNAL	MATERIAL NUMBER	DIM A	DIM C	DIM P	PCB THK
12	45984-4311	35.5	37.90	4.50	3.18
16	45984-4321	38.0	40.44		
20	45984-4331	40.6	42.98		
24	45984-4341	43.1	45.52		
28	45984-4351	45.6	48.06		
32	45984-4361	48.2	50.60		
36	45984-4371	50.7	53.14	3.60	2.36
40	45984-4381	53.3	55.68		
12	45984-4312	35.5	37.90		
16	45984-4322	38.0	40.44		
20	45984-4332	40.6	42.98		
24	45984-4342	43.1	45.52		
28	45984-4352	45.6	48.06	2.90	1.57
32	45984-4362	48.2	50.60		
36	45984-4372	50.7	53.14		
40	45984-4382	53.3	55.68		
12	45984-4313	35.5	37.90		
16	45984-4323	38.0	40.44		
20	45984-4333	40.6	42.98		
24	45984-4343	43.1	45.52		
28	45984-4353	45.6	48.06		
32	45984-4363	48.2	50.60		
36	45984-4373	50.7	53.14		
40	45984-4383	53.3	55.68		

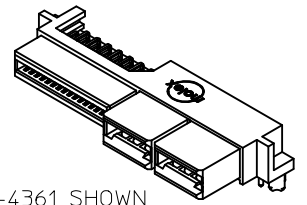

45984-4361 SHOWN
FOR REF ONLY
SEE CHART

REVISED	EC NO: UCP2009-0971	2008/11/13	DESCRIPTION
DRWN:MBANDURA	2008/11/14		
CHKD:	2008/11/14		
APPR:APATEL	2008/11/17		
REV			

GENERAL TOLERANCES (UNLESS SPECIFIED)		
	mm	INCH
4 PLACES	± ---	± ---
3 PLACES	± ---	± ---
2 PLACES	± 0.25	± ---
1 PLACE	± ---	± ---
ANGULAR ±1/2°		
DRAFT WHERE APPLICABLE MUST REMAIN WITHIN DIMENSIONS		

DIMENSION STYLE	
MM ONLY	
DRAWN BY	DATE
SAMIEC	2005/05/13
CHECKED BY	DATE
SAMIEC	2005/05/13
APPROVED BY	DATE
MARGULIS	2005/05/13
MATERIAL NO.	

SCALE	DESIGN UNITS	THIRD ANGLE PROJECTION
1:1	METRIC	
TITLE		
LPH RECEPTACLE ASSEMBLY RT ANGLE 4 CIRCUIT POWER CONNECTOR		
MOLEX INCORPORATED		
DOCUMENT NO.	SHEET NO.	
SD-45984-400	3 OF 5	
THIS DRAWING CONTAINS INFORMATION THAT IS PROPRIETARY TO MOLEX INCORPORATED AND SHOULD NOT BE USED WITHOUT WRITTEN PERMISSION		

5

4

3

2

1

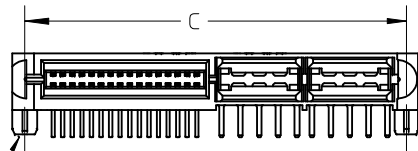
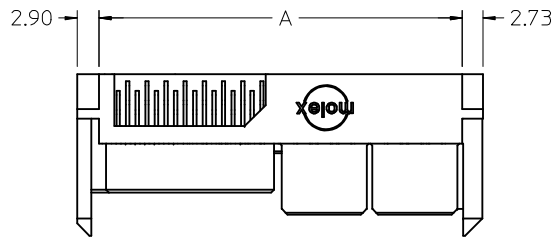

OPTIONAL GUIDES

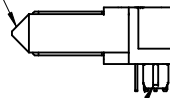

OPTIONAL PEGS

NO OF SIGNALS
OPTIONAL
SEE CHART

GUIDE POST & MOUNTING PEG OPTIONS

NO OF SIGNAL	MATERIAL NUMBER	DIM A	DIM C	DIM P	PCB THK
12	45984-4411	35.5	37.90	4.50	3.18
16	45984-4421	38.0	40.44		
20	45984-4431	40.6	42.98		
24	45984-4441	43.1	45.52		
28	45984-4451	45.6	48.06		
32	45984-4461	48.2	50.60		
36	45984-4471	50.7	53.14	3.60	2.36
40	45984-4481	53.3	55.68		
12	45984-4412	35.5	37.90		
16	45984-4422	38.0	40.44		
20	45984-4432	40.6	42.98		
24	45984-4442	43.1	45.52		
28	45984-4452	45.6	48.06	2.90	1.57
32	45984-4462	48.2	50.60		
36	45984-4472	50.7	53.14		
40	45984-4482	53.3	55.68		
12	45984-4413	35.5	37.90		
16	45984-4423	38.0	40.44		
20	45984-4433	40.6	42.98		
24	45984-4443	43.1	45.52		
28	45984-4453	45.6	48.06		
32	45984-4463	48.2	50.60		
36	45984-4473	50.7	53.14		
40	45984-4483	53.3	55.68		

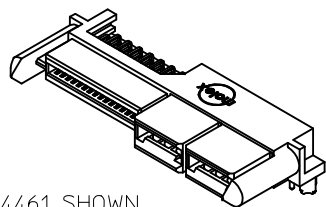

45984-4461 SHOWN
FOR REF ONLY
SEE CHART

REVISED	EC NO: UCP2009-0971	2008/11/13	2008/11/17
DRWN:MBANDURA	2008/11/13		
CHKD:	2008/11/14		
APPR:APATEL	2008/11/17		
REV	DESCRIPTION		

GENERAL TOLERANCES
(UNLESS SPECIFIED)

	mm	INCH
4 PLACES	± ---	± ---
3 PLACES	± ---	± ---
2 PLACES	± 0.25	± ---
1 PLACE	± ---	± ---

ANGULAR ±1/2°

DRAFT WHERE APPLICABLE
MUST REMAIN
WITHIN DIMENSIONS

DIMENSION STYLE
MM ONLY

DRAWN BY	DATE
SAMIEC	2005/05/13
CHECKED BY	DATE
SAMIEC	2005/05/13
APPROVED BY	DATE
MARGULIS	2005/05/13
MATERIAL NO.	

SCALE
1:1

DESIGN UNITS
METRIC

THIRD ANGLE
PROJECTION

TITLE
LPH RECEPTACLE ASSEMBLY
RT ANGLE 4 CIRCUIT
POWER CONNECTOR

molex MOLEX INCORPORATED

DOCUMENT NO.
SD-45984-400

SHEET NO.
4 OF 5

THIS DRAWING CONTAINS INFORMATION THAT IS PROPRIETARY TO MOLEX
INCORPORATED AND SHOULD NOT BE USED WITHOUT WRITTEN PERMISSION

6

5

4

3

2

1

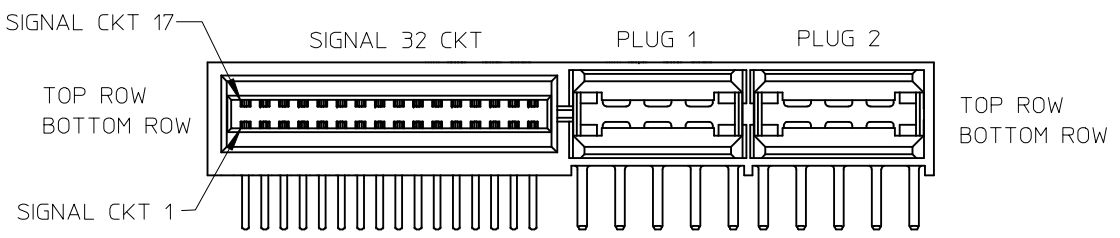

NO. OF SIGNAL	DIM. D
12	8.00
16	10.54
20	13.08
24	15.62
28	18.16
32	20.70
36	23.24
40	25.78

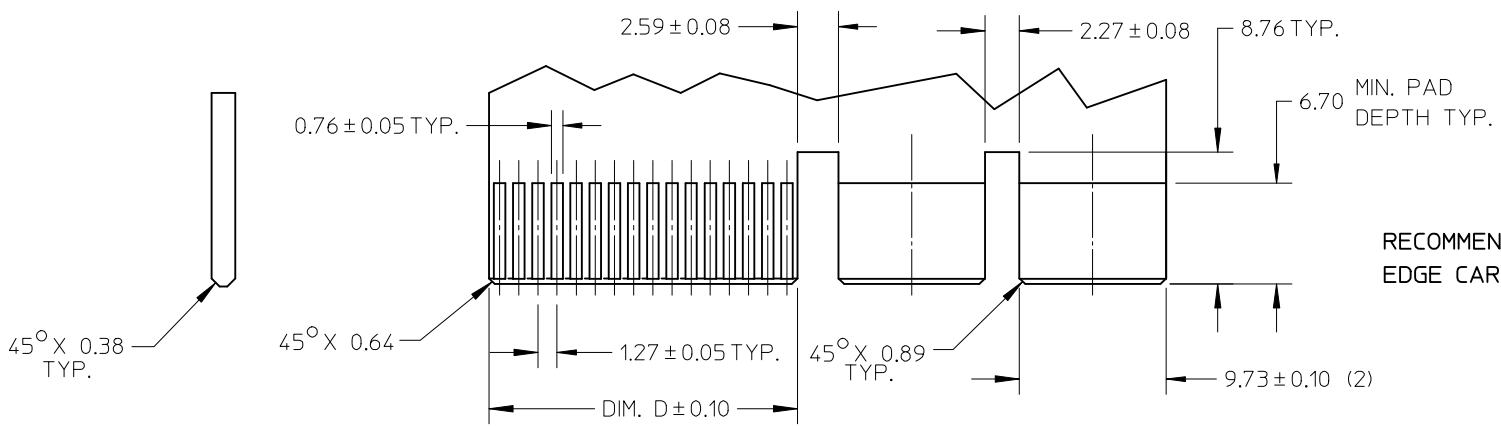

RECOMMENDED EDGE CARD LAYOUT
EDGE CARD THICKNESS: 1.57/0.62

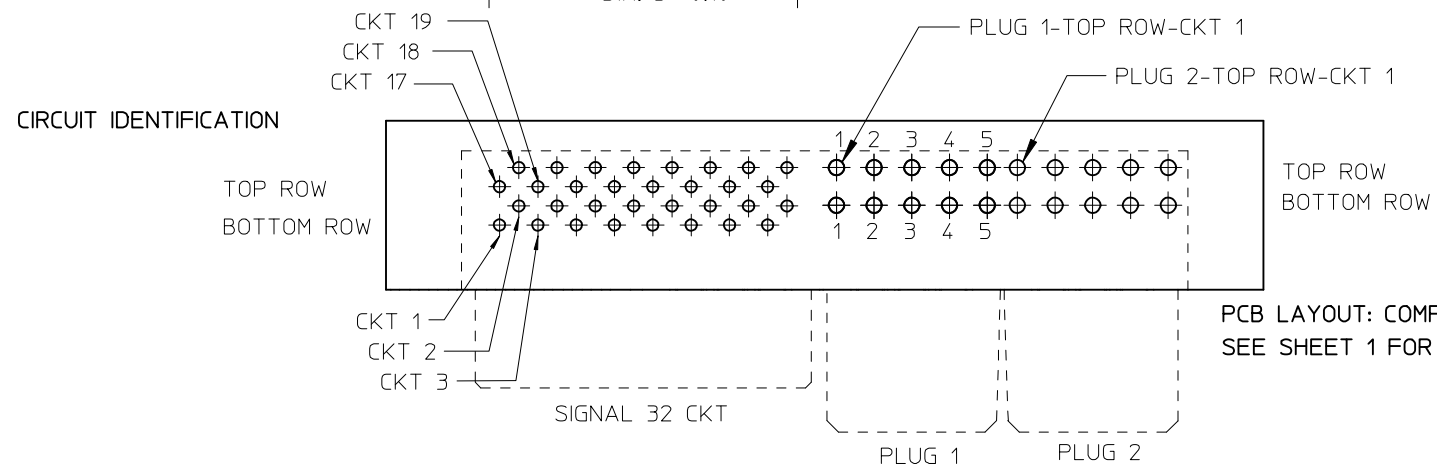

REVISED	EC NO: UCP2009-0971	2008/11/13	DESCRIPTION
	DRWN:MBANDURA	2008/11/14	
	CHKD:		
	APPR:APATEL	2008/11/17	
REV			

GENERAL TOLERANCES (UNLESS SPECIFIED)		
	mm	INCH
4 PLACES	± ---	± ---
3 PLACES	± ---	± ---
2 PLACES	± 0.25	± ---
1 PLACE	± ---	± ---
ANGULAR ± 1/2°		
DRAFT WHERE APPLICABLE MUST REMAIN WITHIN DIMENSIONS		

DIMENSION STYLE MM ONLY	
DRAWN BY SAMIEC	DATE 2005/05/13
CHECKED BY SAMIEC	DATE 2005/05/13
APPROVED BY MARGULIS	DATE 2005/05/13
MATERIAL NO.	

SCALE 2:1	DESIGN UNITS METRIC	THIRD ANGLE PROJECTION
TITLE LPH RECEPTACLE ASSEMBLY RT ANGLE 4 CIRCUIT POWER CONNECTOR		
MOLEX INCORPORATED		
DOCUMENT NO. SD-45984-400	SHEET NO. 5 OF 5	

5

4

3

2

1