

SP7611A/7612/7614 Low Dropout LED Driver for any Color LED

FEATURES

- LED Drivers for parallel connected LEDs
- Ultra Low Dropout Voltage of 150mV (SP7614)
- No EMI, no switching noise
- Integrated current matching
- PWM and Analog brightness control
- Enable/Shutdown control
- Shutdown current < 1 μ A
- Small footprint SC-70 Package

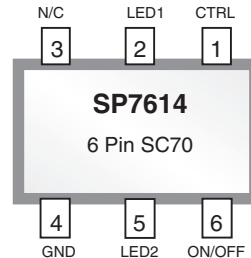

Now Available in Lead Free Packaging

P/N	Channel	I _{BIAS}	I _{BIAS} /LED
SP7611A	4	160	40
SP7612	3	120	40
SP7614	2	160	80

APPLICATIONS

- Next Generation Mobile Phones
- PDA, DSC, MP3 players
- Handheld Computers
- LCD Display Modules
- Keyboard Backlight
- LED Displays

DESCRIPTION

The SP761X driver family provides a simple solution for a matched current source any color LED. The current in the LEDs can be programmed by an external resistor. The Individual LED currents are 200 x I_{SET}, where I_{SET} is the current through the external resistor connected to the CTRL pin. The SP7611A is capable of driving four LEDs, while the SP7612 can drive three LEDs. The SP7614 is designated to drive two high current LEDs. LED1 should always be connected to an LED in order to have the other LEDs driven with a matched current to LED1.

The SP7612 and SP7614 have Enable pins. When these devices are disabled, the supply current drops to 0.01 μ A typical.

The SP7611A, SP7612 and SP7614 drivers are available in a small footprint 6-pin SC-70 package.

TYPICAL APPLICATION SCHEMATIC

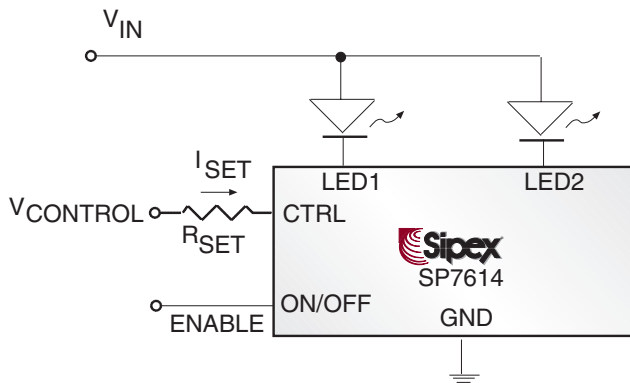

ABSOLUTE MAXIMUM RATINGS

These are stress ratings only and functional operation of the device at these ratings or any other above those indicated in the operation sections of the specifications below is not implied. Exposure to absolute maximum rating conditions for extended periods of time may affect reliability.

V_{LED1} , V_{LED2} , V_{LED3} , V_{LED4} and EN Voltage to GND.....	-0.3V to 6V
CTRL Voltage to GND	0.5V
Output Current (I_{OUT}).....	80mA
Power Dissipation per Package - 6-pin SC-70 at $T_A=85^\circ\text{C}$	190mW
Junction Temperature.....	+150°C
Storage Temperature.....	-55°C to +150°C
ESD Level.....	4kV HBM
ESD Level.....	1kV CDM

ELECTRICAL CHARACTERISTICS

Specifications are at $T_A=25^\circ\text{C}$, $V_{IN}=3.3\text{ to }5.5$, $\text{ENABLE}=V_{IN}$, ♦ denotes the specifications which apply over the full operating temperature range, unless otherwise specified.

PARAMETER	P/N	MIN.	TYP.	MAX.	UNITS
LED Cathode Voltage	SP7611A SP7612	0.3	0.5	1	V
	SP7614	0.15			
Ambient Temperature	SP7614	-40	20	85	°C

PARAMETER	P/N	MIN.	TYP.	MAX.	UNITS		CONDITIONS
Output Current Multiplication Ratio (Note 1)	SP7611A SP7612	140	200	260		♦	$I_{SET} = 100\mu\text{A}$ $V_{SAT} = 300\text{mV}$
	♦					$I_{SET} = 100\mu\text{A}$ $V_{SAT} = 150\text{mV}$	
LED Current I_{LED} (Per Diode)	SP7611A SP7612		20		mA	♦	$I_{SET} = 100\mu\text{A}$ $V_{SAT} = 300\text{mV}$
	♦					$I_{SET} = 100\mu\text{A}$ $V_{SAT} = 150\text{mV}$	
LED to LED Current Matching		-3	0.8	3	%	♦	No Load
Peak Efficiency			90		%	♦	$V_{IN} = 3\text{V}$
Current in OFF Mode			0.01	1	μA	♦	$V_{EN} = 0\text{V}$
Min. ENABLE "ON Voltage"	SP7612 SP7614			3	V	♦	$I_{SET} = 150\mu\text{A}$
Max. ENABLE "OFF Voltage"	SP7612 SP7614	0.5			V	♦	

Note 1: Output current Multiplication Ratio (I_{LED}/I_{SET}) is not linear. For actual ratio and I_{LED} please refer to typical performance characteristics @ page 4.

Pin No.	PIN NAME			DESCRIPTION
	SP7611A	SP7612	SP7614	
1	CTRL	CTRL	CTRL	Sets LED Current
2	LED2	LED2	LED1	Connect to Cathode of LED
3	LED1	LED1	NC	Connect to Cathode of LED
4	GND	GND	GND	Ground
5	LED4	LED3	LED2	Connect to Cathode of LED
6	LED3			Connect to Cathode of LED
		ON/OFF	ON/OFF	Chip ON/OFF/Disable

PINOUT

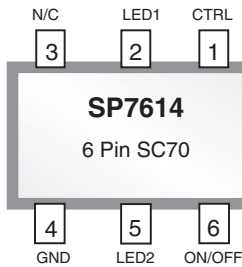
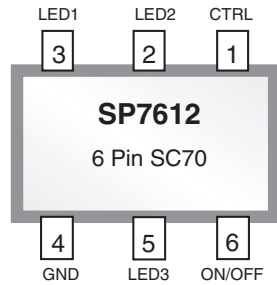
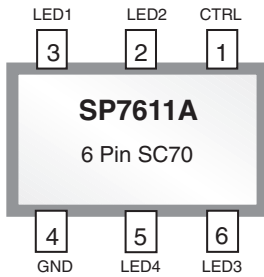

TYPICAL PERFORMANCE CHARACTERISTICS

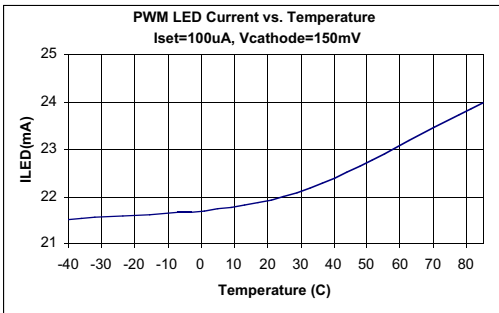
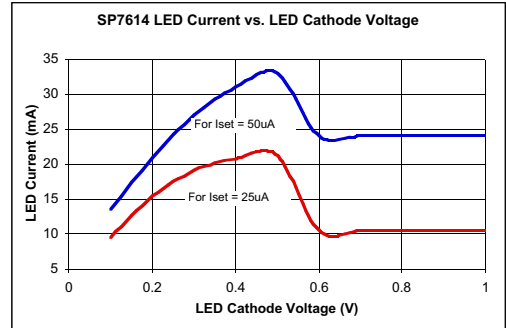
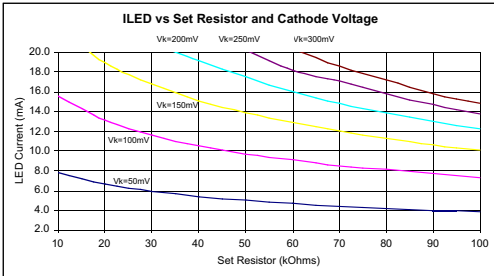
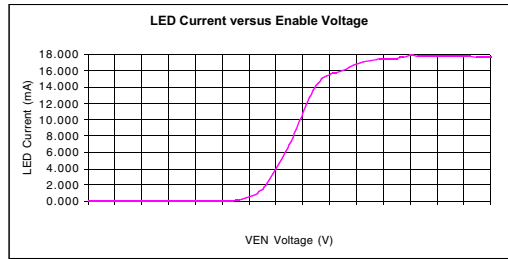
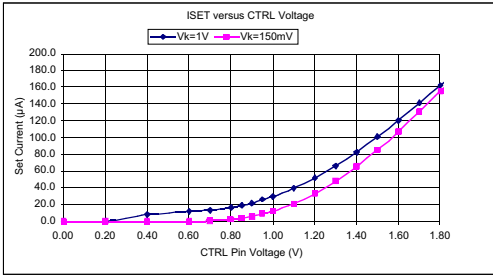

Control Voltage Transient Response

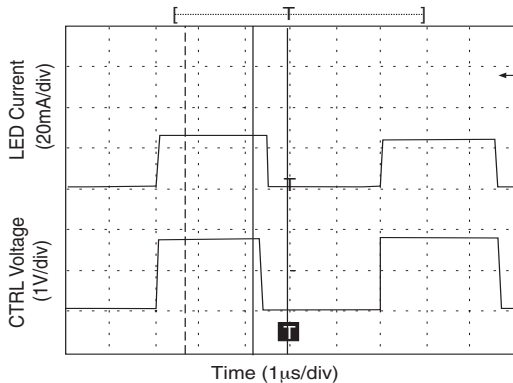

Enable Voltage Transient Response

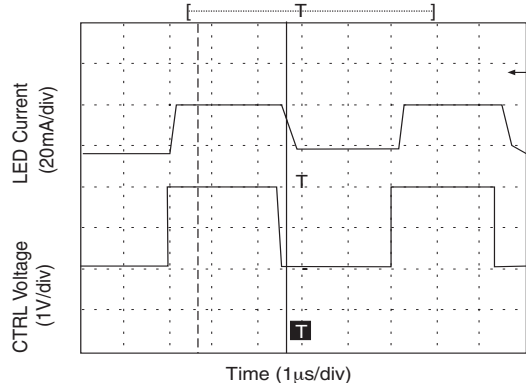

SETTING THE LED CURRENT

The current flowing into LEDs is approximately 200 times greater than the current I_{SET} . The LED current is controlled by $I_{CONTROL}$ and R_{SET} according to the following formula:

$$I_{LED} = 200 \times (V_{CONTROL} - V_{CTRL}) / R_{SET}$$

For $V_{CONTROL} = 3V$ and a specified LED current, the R_{SET} value can be evaluated using the diagram shown in the Typical Performance Characteristics section. For any other option, I_{SET} vs. V_{CTRL} . The LED's brightness can also be adjusted by driving ENABLE or the CTRL pin with a PWM signal. The driving signal frequency should be greater than 100Hz to avoid flickering, increasing to more than 1MHz, if necessary.

LEDs are very sensitive to temperature. In most cases the maximum allowed junction temperature is 100°C. This temperature is the result of adding to the ambient temperature the over temperature due to power dissipation, is described by the following:

$$T_j = T_A + \theta_{JA} \times I \times V_F$$

where T_j is the LED junction temperature, T_A is the ambient temperature, θ_{JA} is the junction to ambient thermal resistance, I is the LED current and V_F is the LED forward voltage.

The SP7611AA to SP7614 are designed to reduce the current through LEDs, when the temperature rises and the cathode voltage increases, as can be seen from typical the "LED Current vs. LED Cathode Voltage" graph under the Typical Performance Characteristics section.

The SP761X driver's low dropout architecture can significantly improve the efficiency compared to using simple ballast resistors.

The system efficiency, defined as the ratio between the LEDs power and the input supplied power can be calculated as follows:

$$\text{Efficiency} = (V_{IN} - V_{CATHODE}) / V_{IN}$$

The lower the $V_{CATHODE}$, the higher the system efficiency. Efficiency can be further improved using a higher V_{IN} with more LEDs as shown in example 3.

APPLICATION NOTES

The ultra-low voltage drop across the SP761X series of LED drivers, allow the devices to drive white, blue, and other color LEDs in a wide range of input voltages. The driver can be used in many applications. Although, only the SP7611A is shown in all three examples, any of the SP762X series of LED drivers can be used in the applications presented in this document, due to their similar operation.

Example 1: Drive low V_F white or blue LEDs directly from single cell Li-ion

When using white or blue low V_F LEDs, and utilizing the drivers low voltage drop, only 3.4V in V_{IN} is needed for the full 20mA LED current. At 3.1V, there is still 5mA typical current available for the LEDs. The single cell Li-ion is utilized in most applications like cell phones or digital still cameras. In most cases, the Li-ion battery voltage level only goes down to 3.0V voltage level, and not down to the full discharge level (2.7V) before requesting the charger.

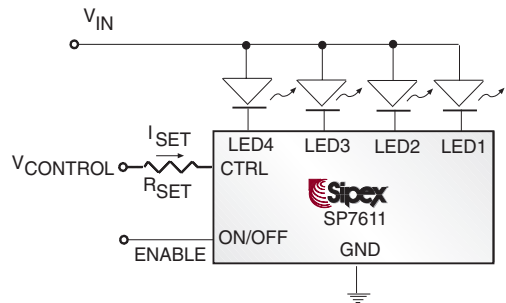

- $T_{DROP} < 0.3V$
- V_F (at 20mA) $< 3.1V$ (Low V_F)
- V_{IN} (at 20mA) $< - V_{DROP} + V_F = 3.4V$
- V_{IN} (at 5mA typical) $\sim 3.1V$

Key Advantages

- 1) No boost circuit needed for the LCD or keyboard backlight
- 2) Drivers directly connected to a Li-ion battery
- 3) No EMI, no switching noise, no boost efficiency lost, no capacitor, and no inductor

Example 2: Drive high V_F white or blue LEDs from existing bus from 4.0V to 5.5V

High V_F white or blue LEDs have forward voltage drop in the range of 3.2V to 4.0V. To drive these LEDs with the maximum current of 20mA for maximum brightness, usually requires a boost circuit for a single cell Li-ion voltage range. In some cases, there is already a voltage bus in the system, which can be utilized. Due to the ultra-low voltage drop of the SP761X series of LED drivers to drive high V_F white or blue LEDs. The V_{IN} needs to be only 300mV higher than the highest V_F in the circuit.

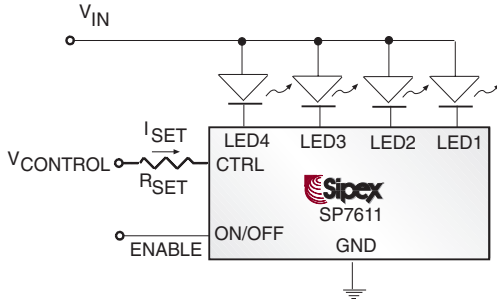

- $T_{DROP} < 0.3V$
- V_F (at 20mA) < 3.3V to 4.0V (High V_F)
- V_{IN} (at 20mA) = $V_{DROP} + V_F = 3.6V$ to 4.3V
- V_{IN} (at 5mA typical) ~ 3.3V

Where V_{IN} = Existing bus = 3.3V to 4.3V

Key Advantages

- 1) No boost circuit needed for the LCD or keyboard backlight
- 2) Drivers utilizes existing bus
- 3) Ultra-low voltage drop provides the full 20mA LED current at the lowest possible voltage level.

Example 3: Drive white, blue red, amber LEDs string

Assuming boost circuit, or existing voltage bus, the SP761X series of LED drivers can be used to drive a whole string of LEDs and flexible brightness control - analog and/or PWM.

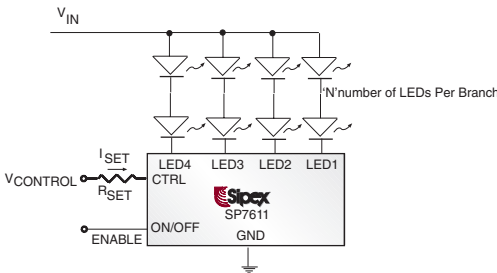

- $V_{DROP} < 0.3V$
- $V_{IN_MIN} = N \times V_F + V_{DROP}$
- $V_{IN_MIN} = N \times V_F + 5.5V$

Where V_{IN} = Existing bus, boost Voltage

Key Advantages

- 1) No need for current matching resistors and discrete transistor for brightness control

LED Brightness Control

All of the SP761X LED Drivers feature analog and PWM controls to give designers flexible brightness control. These control methods can be applied to the circuit in two different ways, to provide more flexibility than any other solution. To determine the value of R_{SET} , use the " I_{SET} vs. V_{CTRL} " graph under the Typical Performance Characteristics.

1. SP7611A

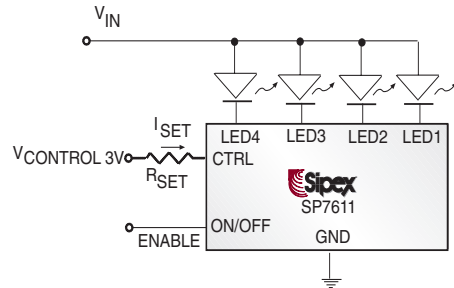

- Analog

Set $V_{CONTROL}$ and R_{SET} for LED current

$$I_{LED} = 200 \times (V_{CONTROL} - V_{CNTR}) / R_{SET}$$

- PWM

$$V_{CONTROL} = PWM$$

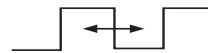

- Amplitude sets maximum LED current
- Pulse width controls between 0 and maximum

2. SP7612

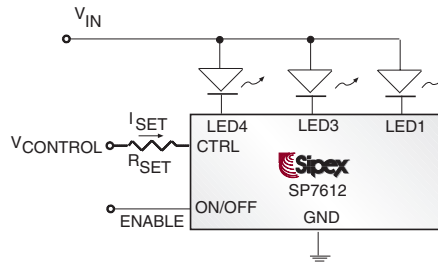

- Analog

Set $V_{CONTROL}$ and R_{SET} for LED current

- PWM -1

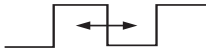

$$I_{LED} = 200 \times (V_{CONTROL} - V_{CTRL}) / R_{SET}$$

-Amplitude sets maximum LED current

-Pulse width controls between 0 and maximum

- PWM -2

Set $V_{CONTROL}$ and R_{SET} for LED current

$$I_{LED} \sim 200 \times I_{SET}$$

ON/OFF = PWM

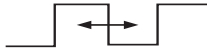

-Amplitude has no effect on current

-Pulse width controls between 0 and maximum

3. SP7614

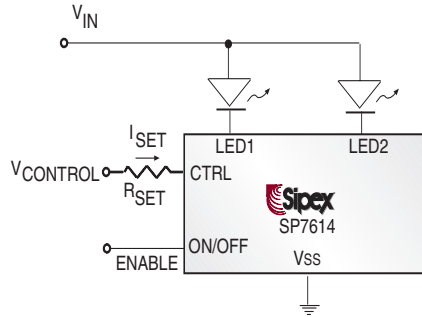

- Analog

Set $V_{CONTROL}$ and R_{SET} for LED current

$$I_{LED} = 200 \times (V_{CONTROL} - V_{CTRL}) / R_{SET}$$

- PWM - 1

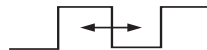

-Amplitude sets maximum LED current

-Pulse width controls between 0 and maximum

- PWM - 2

Set $V_{CONTROL}$ and R_{SET} for LED current

$$I_{LED} \sim 200 \times I_{SET}$$

ON/OFF = PWM

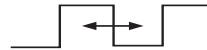

-Amplitude has no effect on current

-Pulse width controls between 0 and maximum

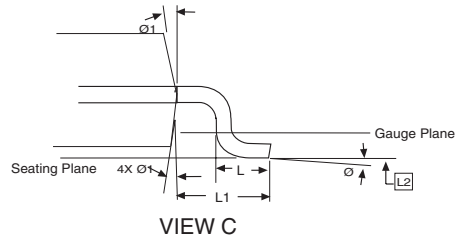
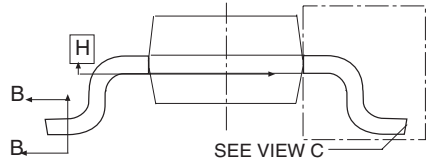
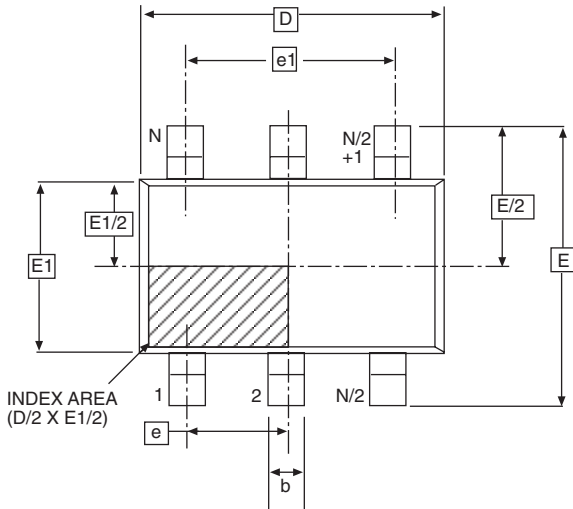

Dimensions in (mm)	6 PIN SC-70 JEDEC MO-203 (AB) Variation		
	MIN	NOM	MAX
A	-	-	1.10
A1	0	-	0.10
A2	0.70	0.90	1.00
b	0.15	-	0.30
c	0.08	-	0.22
D	2.00 BSC		
E	2.10 BSC		
E1	1.25 BSC		
L	0.26	0.36	0.46
L1	0.42 REF		
L2	0.15 BSC		
Ø	0°	4°	8°
Ø1	4°	-	12°

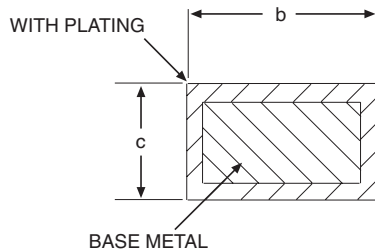
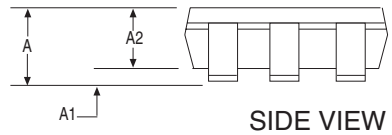

6 PIN SC-70

Part Number	Temperature Range	Package Type
SP7611AEC6	-40°C to +85°C	6 Pin SC-70
SP7611AEC6/TR	-40°C to +85°C	6 Pin SC-70
SP7612EC6	-40°C to +85°C	6 Pin SC-70
SP7612EC6/TR	-40°C to +85°C	6 Pin SC-70
SP7614EC6	-40°C to +85°C	6 Pin SC-70
SP7614EC6/TR	-40°C to +85°C	6 Pin SC-70

Available in lead free packaging. To order add "-L" suffix to part number.

Example: SP7614EC6/TR = standard; SP7614EC6-L/TR = lead free

/TR = Tape and Reel

Pack quantity is 2500 for SC70.



ANALOG EXCELLENCE

Sipex Corporation

**Headquarters and
Sales Office**
233 South Hillview Drive
Milpitas, CA 95035
TEL: (408) 934-7500
FAX: (408) 935-7600

Sipex Corporation reserves the right to make changes to any products described herein. Sipex does not assume any liability arising out of the application or use of any product or circuit described herein; neither does it convey any license under its patent rights nor the rights of others.