

Mini Feed-Through 15mm

For wire-to-wire connecting in control, automation, instrumentation and power distribution applications.

Altech "miniature" terminal blocks offer tremendous space advantage as demanded by certain wiring configurations.



	CMT4			CGMT4		
Terminal Width	6 mm			6 mm		
Height x Length	29 x 27 mm			28.5 x 27 mm		
Stripping Length	9 mm			9 mm		
Insulation Material	Polyamide 6.6			Polyamide 6.6		
Type of Connection	2 screw clamps & 1 tapped hole for cross connection			2 screw clamps		
Approvals						
Wire Range	22-10 AWG	0.5-4 sq.mm	22-10 AWG	22-10 AWG	0.5-4 sq.mm	22-10 AWG
Voltage Rating	300 V	400 V	300 V			
Current Rating	35 A	32 A	35 A		32A	
Torque	6 lb-in	0.5 Nm	7 lb-in	7 lb-in	0.5 Nm	7 lb-in
Other Approvals						
	Cat. No.	Std. Pk.		Cat. No.	Std. Pk.	
Terminal Block	CMT4	100		CGMT4	50	
End Plate	EPCMT4	50				
Isolation Partition	PPCMT4	50				
DIN Rail for ordering information refer to page 70						
End Stop for ordering information refer to page 72	CA602	100				
Internal Jumper	2 pole	CA727/2	100			
	3 pole	CA727/3	100			
	4 pole	CA727/4	100			
	10 pole	CA727/10	10			
Insulated Internal Jumper	2 pole	CA747/2	100			
	3 pole	CA747/3	100			
	4 pole	CA747/4	100			
	10 pole	CA747/10	10			
Current Bars	2 pole	CA703/1	100			
	3 pole	CA704/1	100			
	4 pole	CA705/1	100			
	10 pole	CA732/10	100			
	10 pole (breakable)	CA732/10-A	100			
	100 pole	CA732/100	10			
Shorting Sleeve & Screw		CA607/S/Q	100			
External Jumper	2 pole	CA714/2	100			
	3 pole	CA714/3	100			
	4 pole	CA714/4	100			
	10 pole	CA714/10	20			
Marking Tags (MT Type)	MT2	100		MT2	100	

COLOR BLOCKS
(other than grey standard)

When ordering please add color suffix to Cat. No.

Example: CTS2.5U-N/R











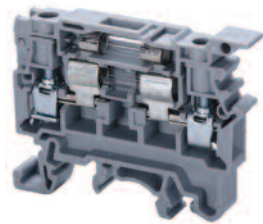
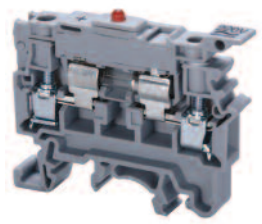





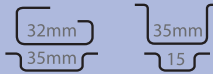

Color	Ordering Suffix
Red	R
Blue	BU
Black	BL
Orange	O
Green	G
Yellow	Y
White	W
Beige	BG
Dark Brown	DB

Certain electrical and control systems require protection by fuses. The terminal has a hinged carrier that has a specially designed space for a cartridge type glass fuse of size Ø5 x 20 or Ø5 x 25 mm. The fuse can be engaged or disengaged by the movement of the carrier.

Altech fuse terminals are also available with light indication - CSFL 4U (L). A specially de-signed built-in circuit gives light indication in the event of fuse blow out.

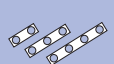
† Fuses are sold separately Altech, see pages 23-24.

*Add required voltage to part number as a suffix, i.e. CSFL4U(L)/24 for 24V DC

	CSFL4U			CSFL4U(L)*		
						
	† Fuse not included.			† Fuse not included.		
Terminal Width	8 mm			8 mm		
Height x Length	43 x 58 mm			43 x 58 mm		
Stripping Length	9.5 mm			9.5 mm		
Insulation Material	Polyamide 6.6			Polyamide 6.6		
Type of Connection	2 screw clamps			2 screw clamps		
LED Voltage				24V AC/DC, 48V AC/DC, 110V AC/DC, 220V AC, 300V AC		
Type of Fuse Used	Ø5x20, Ø5x25mm			Ø5x20, Ø5x25mm		
Approvals						
Wire Range	22-10 AWG	0.5-4 sq.mm	22-10 AWG	22-10 AWG	0.5-4 sq.mm	22-10 AWG
Voltage Rating	600 V	500 V	600 V	600 V	500 V	600 V
Current Rating	6.3 A	6.3 A	8 A	6.3 A	6.3 A	8 A
Torque	7 lb-in	0.5 Nm	7 lb-in	7 lb-in	0.5 Nm	7 lb-in
Other Approvals						
	Cat. No.	Std. Pk.		Cat. No.	Std. Pk.	
Terminal Block	CSFL4U	100		CSFL4U(L)*	100	
End Plate 	EPCSFL4U	50		EPCSFL4U	50	
Isolation Partition 	PPCSFL4U	50		PPCSFL4U	50	
DIN Rail for ordering information refer to page 70						
End Stop for ordering information refer to page 72 	CA602	100		CA602	100	
Internal Jumper 	2 pole 3 pole 4 pole 10 pole					
Insulated Internal Jumper 	2 pole 3 pole 4 pole 10 pole					
Current Bars 	2 pole 3 pole 4 pole 10 pole 10 pole (breakable) 100 pole					
Shorting Sleeve & Screw 						
External Jumper 	2 pole 3 pole 4 pole 10 pole	CA711/2 100 CA711/3 50 CA711/4 50 CA711/10 20		CA711/2 100 CA711/3 50 CA711/4 50 CA711/10 20		
Marking Tags (MT Type) 	MT8 MT2	100 100		MT8 MT2	100 100	

Mini Feed-Through Panel Mount

For use when space constraints require extremely compact solutions and internal jumping is required.

Individual components can be used to build your own assemblies. Just snap the required number of terminal block components together and place a Mounting Section on each end.

The CMB4 accepts internal jumpers and standard marking tags.

- Extremely compact and cost effective
- High density
- Screw-cage clamp
- Internal jumping provision
- Polyamide 6.6
- Standard color: gray

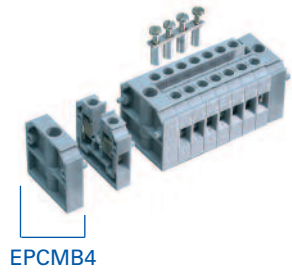
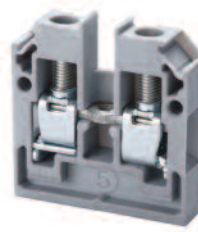
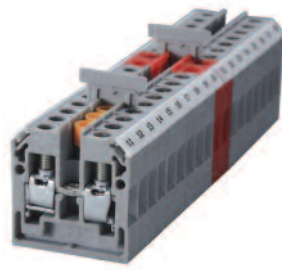

EPCMB4

Terminal Width	6 mm		
Height x Length	28 x 27 mm		
Stripping Length	9 mm		
Insulation Material	Polyamide 6.6		
Type of Connection	2 screw clamps & 1 tapped hole for cross connect.		
Approvals			
Wire Range	22-10 AWG	0.5-4 sq.mm	22-10 AWG
Voltage Rating	300 V	400 V	300 V
Current Rating	35 A	32 A	35 A
Torque	7 lb-in	0.5 Nm	7 lb-in
Other Approvals			

Preassembled blocks are also available for quick and easy installations.
See Dimensions below.

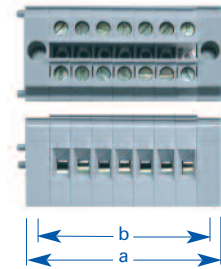

Dimensions mm (in.)
CMB4

Terminal Block

Mounting Section	Cat. No.	Std. Pk.
EPCMB4	50	
Separator Plate	SPCMB4	100
Mounting Screw*	Any length M3 screw may be used.	
Internal Jumper	2 pole 3 pole 4 pole 10 pole	CA727/2 100 CA727/3 100 CA727/4 100 CA727/10 10
Insulated Internal Jumper	2 pole 3 pole 4 pole 10 pole	CA747/2 100 CA747/3 100 CA747/4 100 CA747/10 10
Current Bars	2 pole 3 pole 4 pole 10 pole 10 pole (breakable) 100 pole	CA703/1 100 CA704/1 100 CA705/1 100 CA732/10 100 CA732/10-A 100 CA732/100 10
Shorting Sleeve & Screw		CA607/S/Q 100
External Jumper	2 pole 3 pole 4 pole 10 pole	CA714/2 100 CA714/3 100 CA714/4 100 CA714/10 20
Marking Tags (MT Type)		MT2 100

Cat. No.	No. of Poles	Width (a)	Hole Spacing (b)
CMB4/2	2	26 (1.02)	19 (0.75)
CMB4/3	3	32 (1.26)	25 (0.98)
CMB4/4	4	38 (1.50)	31 (1.22)
CMB4/5	5	44 (1.73)	37 (1.46)
CMB4/6	6	50 (1.97)	43 (1.69)
CMB4/7	7	56 (2.20)	49 (1.93)
CMB4/8	8	62 (2.44)	55 (2.17)
CMB4/9	9	68 (2.68)	61 (2.40)
CMB4/10	10	74 (2.91)	67 (2.64)
CMB4/11	11	80 (3.15)	73 (2.87)
CMB4/12	12	86 (3.39)	79 (3.11)
CMB4/13	13	92 (3.62)	85 (3.35)
CMB4/14	14	98 (3.86)	91 (3.58)
CMB4/15	15	104 (4.09)	97 (3.82)
CMB4/16	16	110 (4.33)	103 (4.06)
CMB4/17	17	116 (4.57)	109 (4.29)
CMB4/18	18	122 (4.80)	115 (4.53)
CMB4/19	19	128 (5.04)	121 (4.76)
CMB4/20	20	134 (5.28)	127 (5.00)
CMB4/21	21	140 (5.51)	133 (5.24)
CMB4/22	22	146 (5.75)	139 (5.47)
CMB4/23	23	152 (5.98)	145 (5.71)
CMB4/24	24	158 (6.22)	151 (5.94)

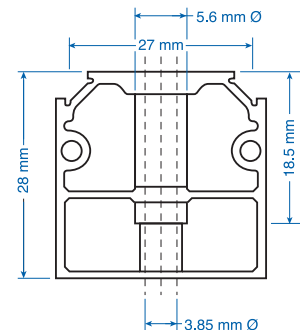

Mounting Section
EPCMB4

* Any length M3 screw may be used.

COLOR BLOCKS
(other than grey standard)

When ordering please add color suffix to Cat. No.

Example: CTS2.5U-N/R

Color	Ordering Suffix
Red	R
Blue	BU
Black	BL
Orange	O
Green	G
Yellow	Y
White	W
Beige	BG
Dark Brown	DB

Panel Mount Spring Clamp

Altech "screwless" spring clamp panel mount terminal blocks are an excellent solution for extremely compact wiring applications.

These terminal blocks are "add-on" type and can be combined to form multiple assemblies. The stacked assembly is fitted with mounting end sections on both ends for easy installation on to the panel.

The terminal has marker holding recesses on three sides to accept marking tags. Cross connection can be achieved with the aid of insulated jumpers.

The CSCP2.5T2 panel mount terminal blocks have two connection points on each side all with the same potential. The terminals provide possibility of further multiplication through jumpering.



CSCP2.5T



CSCP2.5T2



Terminal Width	5 mm			10 mm		
Height x Length	27 x 35 mm			27 x 35 mm		
Stripping Length	14 mm			14 mm		
Insulation Material	Polyamide 6.6			Polyamide 6.6		
Type of Connection	2 spring clamp connections			4 spring clamp connections		
Approvals						
Wire Range	22-14 AWG	0.5-2.5 sq.mm	22-14 AWG	22-14 AWG	0.5-2.5 sq.mm	22-14 AWG
Voltage Rating	600 V	750 V	600 V	600 V	750 V	600 V
Current Rating	20 A	24 A	20 A	20 A	24 A	20 A
Other Approvals						

	Cat. No.	Std. Pk.	Cat. No.	Std. Pk.
Terminal Block	CSCP2.5T	100	CSCP2.5T2	100
End Section (set of left and right)	EPCSCP2.5T	25	EPCSCP2.5T	25
Insulated Jumper (2 pole)	CA803/1	100	CA803/1	100
Operating Tool	SCA2-5	1	SCA2-5	1
Marking Tags (MT Type)	MT4	100	MT3	100

COLOR BLOCKS
(other than grey standard)

When ordering please add color suffix to Cat. No.

Example: CTS2.5U-N/R

Color	Ordering Suffix
Red	R
Blue	BU
Black	BL
Orange	O
Green	G
Yellow	Y
White	W
Beige	BG
Dark Brown	DB

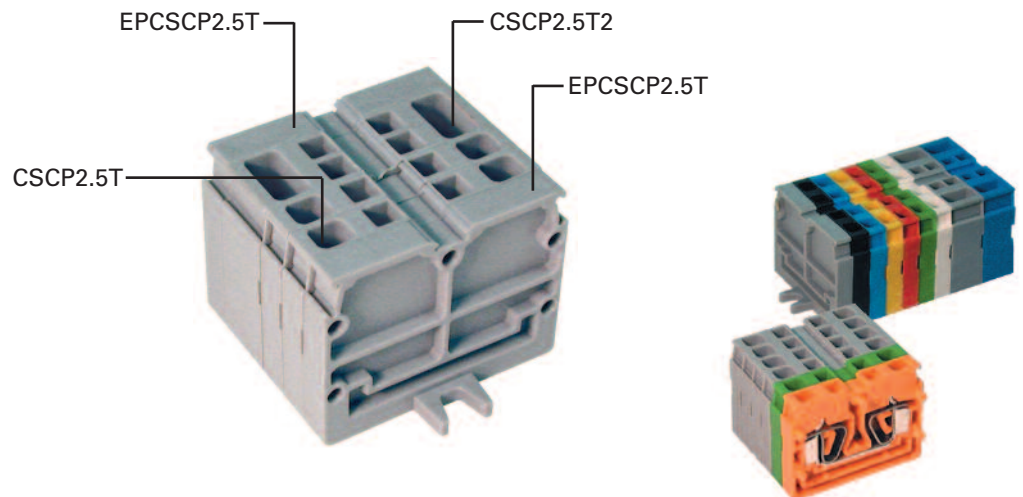

Suitable for use in high temperature applications up to 600°C (1112°F). Applications include hot melt glue guns, furnaces, heaters, process equipment and machinery. Terminal blocks are offered with mounting holes for panel mounting or free floating applications.

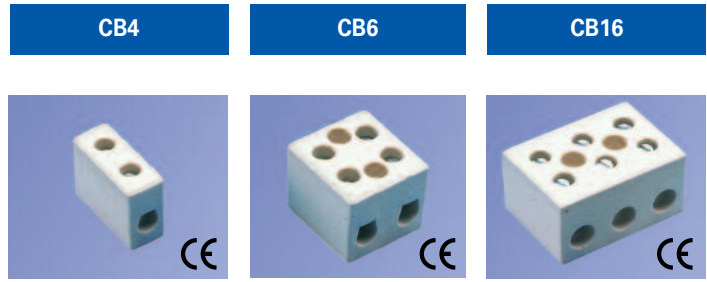

- Compact, space saving
- Tubular screw clamp
- Free float or panel mount
- Temperature range: -40°C (-40°F) to 600°C (1112°F)
- Standard color: white
- Material
Housing: Steatite
Clamp: Brass
Screws: Zinc plated steel

Insulation Material	Ceramic		Ceramic		Ceramic	
Approvals						
Wire Range	24-12 AWG	24-12 AWG	22-10 AWG	20-10 AWG	20-6 AWG	18-6 AWG
Voltage Rating	300V	300V	300V	300V	300V	300V
Current Rating	30 A	20 A	40 A	30 A	76 A	65 A
No. of Poles	Cat. No.	Std. Pk.	Cat. No.	Std. Pk.	Cat. No.	Std. Pk.
1 (free floating)	CB4/1	50	CB6/1	50		
2 (free floating)	CB4/2	50				
2 (with mounting holes)	CB4/2H	50	CB6/2H	50	CB16/2H	50
3 (free floating)	CB4/3	50				
3 (with mounting holes)	CB4/3H	50	CB6/3H	50	CB16/3H	50

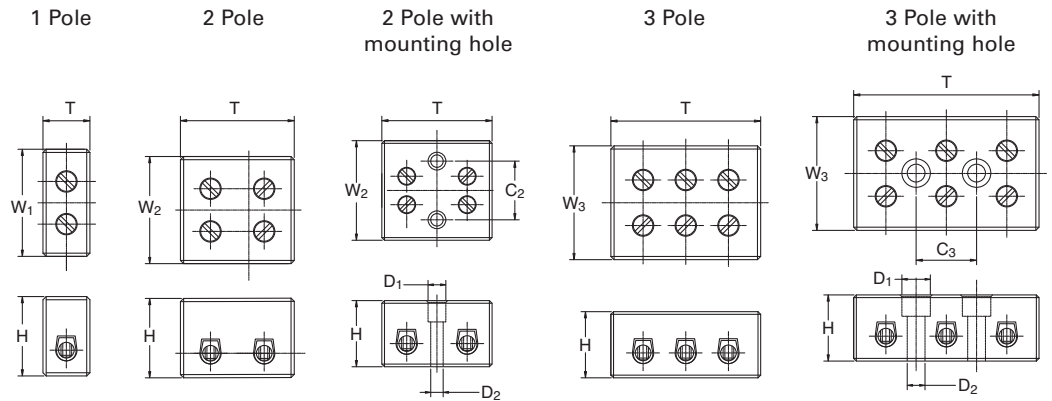

		Dimensions mm							Fixing Screw	Stripping Length
		W	T	H	C	D1	D2			
CB4/1	1 POLE	23	11	18.5	*				6	
CB4/2	2 POLE	23	18	18.5	*				6	
CB4/2H	2 POLE	23	24	18.5	14.6	6	3.5	M3X16	6	
CB4/3	3 POLE	25	25	18.5	*				6	
CB4/3H	3 POLE	25.4	36	18.5	13	6	3.5	M3X16	6	
CB6/1	1 POLE	25	12	19.5	*				6	
CB6/2H	2 POLE	25.5	26	19.5	12.6	6		M3X16	6	
CB6/3H	3 POLE	25.5	41	19.5	15	6		M3X16	6	
CB16/2H	2 POLE	28	31	23.2	16.5	6	3.5	M3X20	8.5	
CB16/3H	3 POLE	27.5	48	23.2	17	6	3.5	M3X20	8.5	

Note: All dimensions are shown in mm, to convert to inches please divide by 25.4.

A quick reliable solution for ground, neutral or low voltage distribution applications. The Busbar System consists of a busbar, busbar supports, and screw clamp terminals for terminating wires

NEB 10 (10 x 3 mm) and NEB 6 (6 x 6 mm), tin plated copper busbars are available in one meter lengths. Both have a 140A current carrying capacity.

NES plastic support with fixing screws for holding 10 x 3 & 6 x 6 busbar makes placing of busbar an easy task. Busbars up to 200 mm length should be supported at ends by two busbar supports. For busbars exceeding 200 mm length, it is recommended to provide intermediate busbar support. Easy to operate CENC clamp secures wire to the busbar.



	CENC4	CENC16	CENC35
--	-------	--------	--------



Terminal Width	7.5 mm		9.8 mm		14.5 mm				
Height x Length	30 x 23.3 mm		36 x 23.3 mm		45 x 27.3 mm				
Stripping Length	12 mm		16 mm		16 mm				
Insulation Material	Polyamide 6.6		Polyamide 6.6		Polyamide 6.6				
Type of Connection	1 screw clamp connection		1 screw clamp connection		1 screw clamp connection				
Approvals									
Wire Range	22-10 AWG	0.5-6 sq.mm	22-12 AWG	10-4 AWG	6-16 sq.mm	10-6 AWG	8-2 AWG	10-35 sq.mm	8-2 AWG
Current Rating*	35 A	41 A		80 A	76 A		125 A	125 A	
Torque	14 lb-in	0.8 Nm	14 lb-in	14 lb-in	2.0 Nm	17.5 lb-in	25 lb-in	2.5 Nm	25 lb-in
Other Approvals									

	Cat. No.	Std. Pk.	Cat. No.	Std. Pk.	Cat. No.	Std. Pk.
Terminal Block**	CENC4	50	CENC16	50	CENC35	50
Busbar (10 x 3 mm)	NEB10	1 m	NEB10	1 m	NEB10	1 m
Busbar (6 x 6 mm)	NEB6	1 m	NEB6	1 m	NEB6	1 m
Plastic Support with Fixing Screw	NES	50	NES	50	NES	50
End Clamp/Bus bar support for rail mounting	CA202	50	CA202	50	CA202	50
Marking Tags (MT Type)	MT5	100	MT6	100	MT6	100

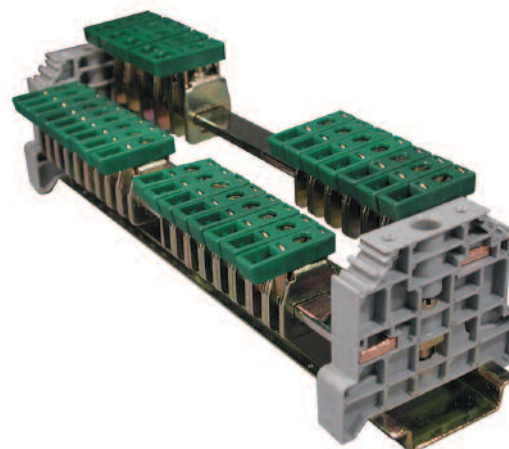

* 140A current carrying capacity of busbar should be taken into account while connecting loads.

** Consult for other available colors.