

**Product Description**

Teccor's TO-92 and surface mount bilateral trigger diacs offer a range of voltage characteristics from 30 to 45 volts.

The diac semiconductor is a full-wave or bidirectional thyristor. It is triggered from a blocking-to-conduction state for either polarity of applied voltage whenever the amplitude of applied voltage exceeds the breakover voltage rating of the diac.

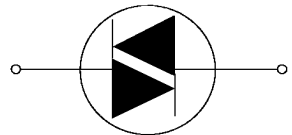
Teccor diacs feature glass-passivated junctions to ensure long term device reliability and parameter stability. Teccor's glass offers a rugged, reliable barrier against junction contamination.

The diac specifications listed in this data sheet are for standard products. Special parameter selections such as close tolerance voltage symmetry are available. Please consult the factory for more information for custom design applications. Suffix RP signifies tape-and-reel packing. Example: ET36BRP.



**Features**

- Glass-chip passivation
- Epoxy through-hole and SMT packages
- Pre-tinned leads
- Wide voltage range selections
- High temperature solder bonded die attachment

Bilateral Trigger  
Diacs  
ET and ST Series



# Electrical Specifications

ELECTRICAL CHARACTERISTICS $T_C = 25^\circ\text{C}$							
Part Number		$V_{BO}$		$\Delta V_{BO}$	$V_{BB}$	$I_{BO}$	$I_{TRM}$
		Breakover Voltage (Forward and Reverse)		Breakover Voltage Symmetry $\Delta V_{BO} = [ +V_{BO}  -  -V_{BO} ]$	Dynamic Breakback Voltage (3) $ \Delta V_{\pm} $	Peak Breakover Current at Breakover Voltage	Peak Pulse Current for 10 $\mu\text{s}$ 120 PPS $T_A \leq 40^\circ\text{C}$
		Volts		Volts	Volts	$\mu\text{Amps}$	Amps
		MIN	MAX	MAX	MIN	MAX	MAX
ET-34B	ST-34B	32	36	2 (1)	10 (2)	25	2.0
ET-35	ST-35	30	40	3 (1)	10 (2)	25	2.0
ET-36A	ST-36A	32	40	2 (1)	7 at 10mA (4)	25	2.0
ET-36B	ST-36B	34	38	2 (1)	10 (2)	25	2.0
ET-40	ST-40	35	45	3 (1)	10 (2)	25	2.0

## Electrical Specification Notes

- (1) Breakover Voltage symmetry as close as 1.0V is available from factory on these products.
- (2) See Figures 4 & 5 for Test Circuit and waveforms.
- (3) Typical switching time is 900 nano-seconds measured at  $I_{PK}$  (see Figure 4) across a 20 $\Omega$  resistor (see Figure 5). Switching time defined as rise time of  $I_{PK}$  between the 10% to 90% points.
- (4) See Figure 7.

## General Notes

- Lead solder temperature is +230 $^\circ\text{C}$  max. for 10 seconds max.;  $\geq 1/16"$  (1.59mm) from case.
- See Package Dimensions on sheet 5 of this Data Sheet.

## Bilateral Trigger Diac Specifications

- **Maximum Ratings, Absolute-Maximum Values**  
 Maximum Trigger Firing Capacitance: 0.1 $\mu\text{F}$   
 Device Dissipation (at  $T_A = -40^\circ\text{C}$  to  $+40^\circ\text{C}$ ): 300mW  
 Derate Above  $+40^\circ\text{C}$ : 3mW/ $^\circ\text{C}$
- **Temperature Ranges**  
 Storage:  $-40^\circ\text{C}$  to  $+150^\circ\text{C}$   
 Operating (Junction):  $-40^\circ\text{C}$  to  $+125^\circ\text{C}$

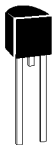

Thermal Resistance	
Junction to Lead - $R_{\theta JL}$ : $^\circ\text{C/W}$	
Junction to Ambient [ $R_{\theta JA}$ ]: $^\circ\text{C/W}$	
(based on maximum lead temperature of 90 $^\circ\text{C}$ )	
	
80 [215] $^\circ\text{C/W}$	65 [200] $^\circ\text{C/W}$

Figure 1: Typical Diac-Triac Full-Wave Phase Control Circuit using Lower Voltage Diacs.

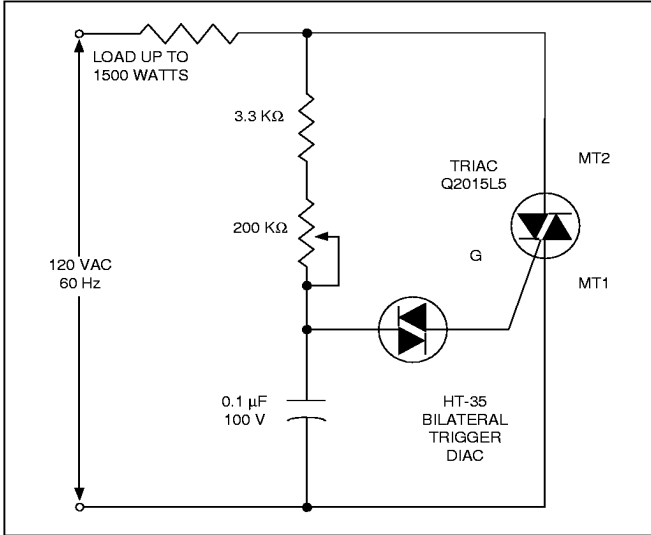


Figure 2: Normalized  $V_{BO}$  Change vs. Junction Temperature

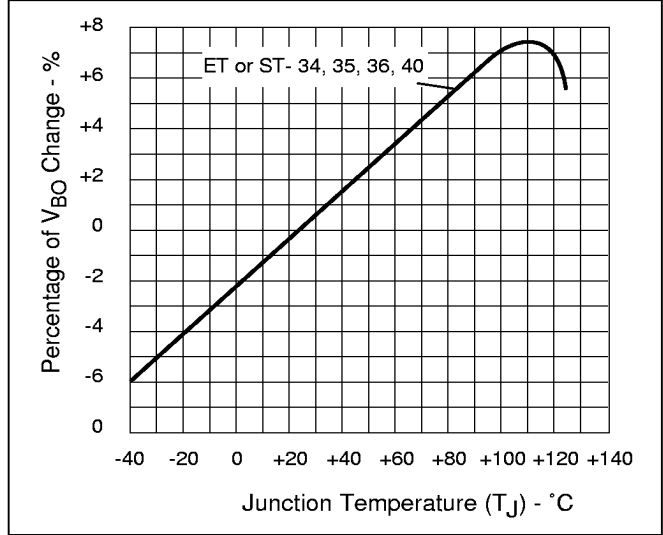


Figure 3: Repetitive Peak On-State Current vs. Pulse Duration

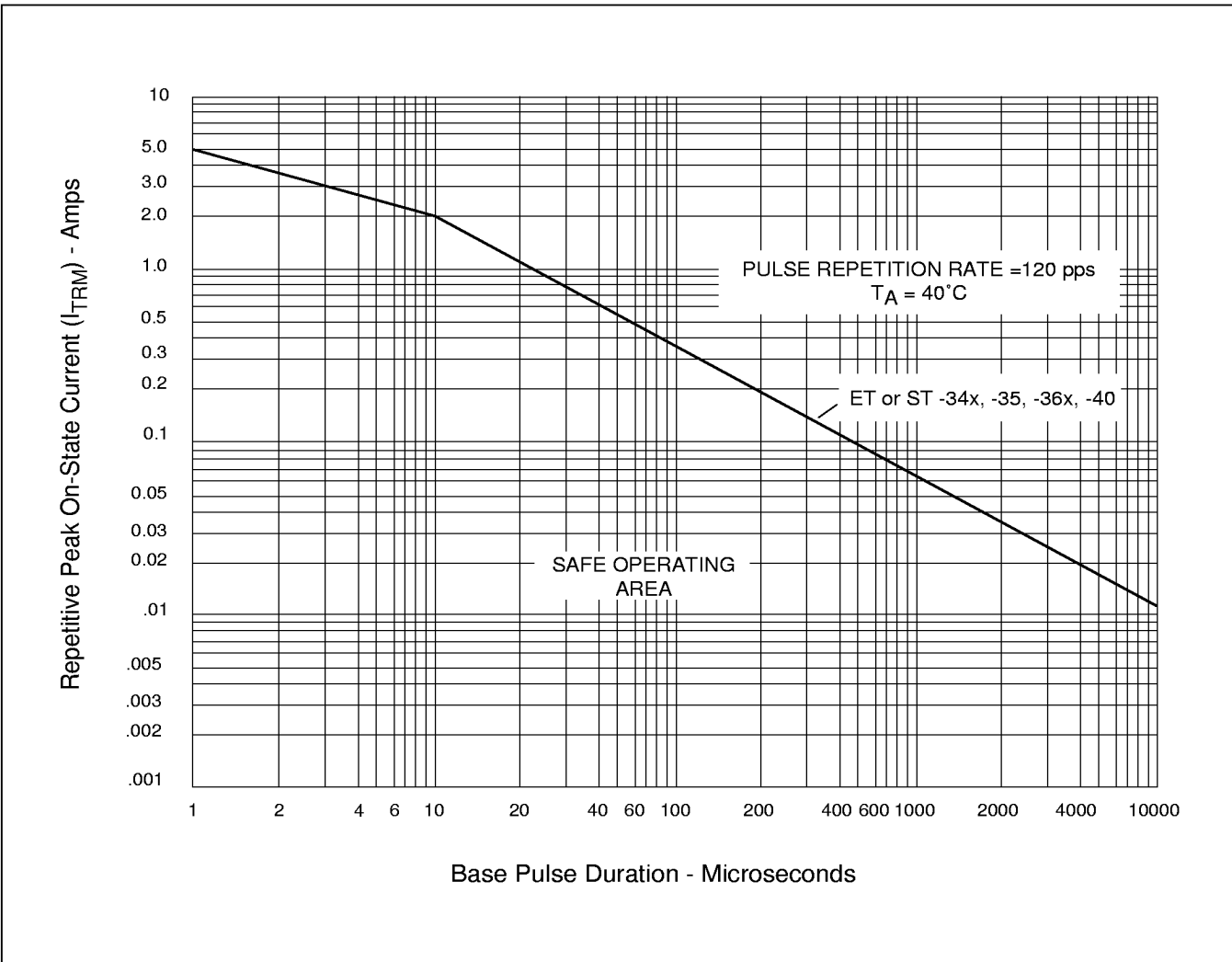


Figure 4: Test Circuit Waveforms (see figure 5).

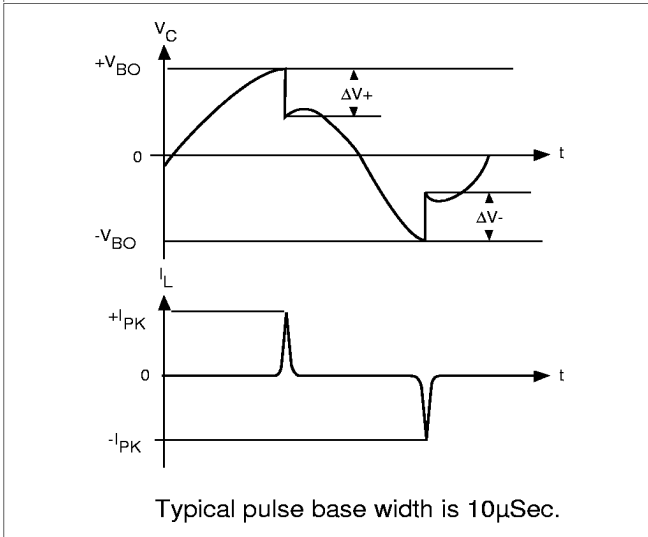


Figure 5: Circuit Used to Measure Diac Characteristics (See Figure 4.)

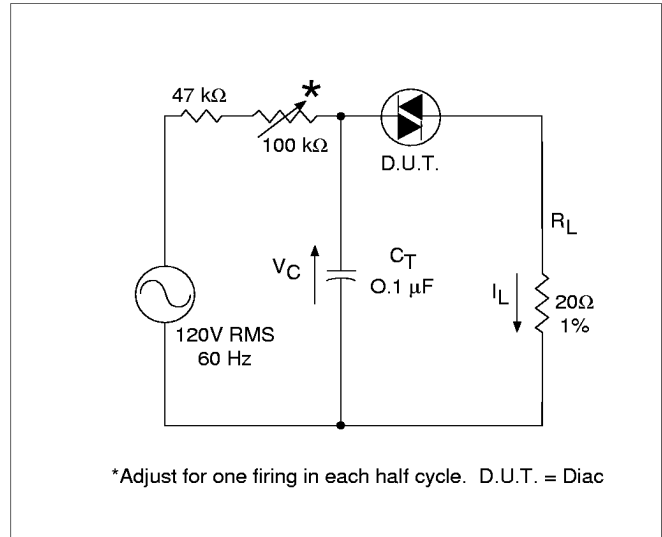


Figure 6: Peak output Current vs. Triggering Capacitance

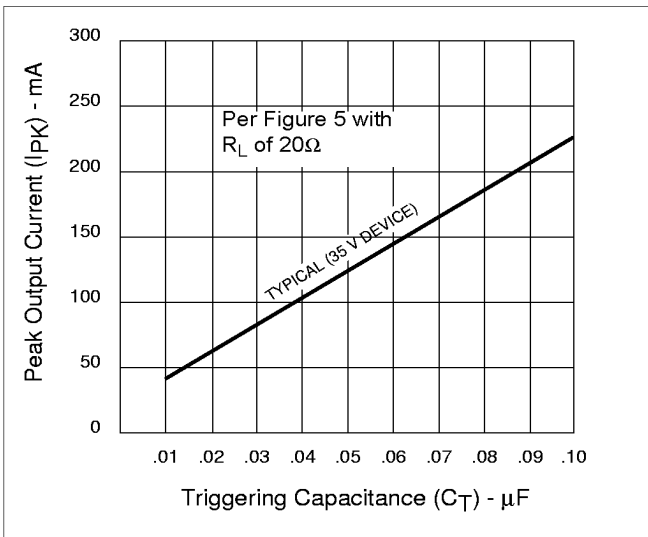
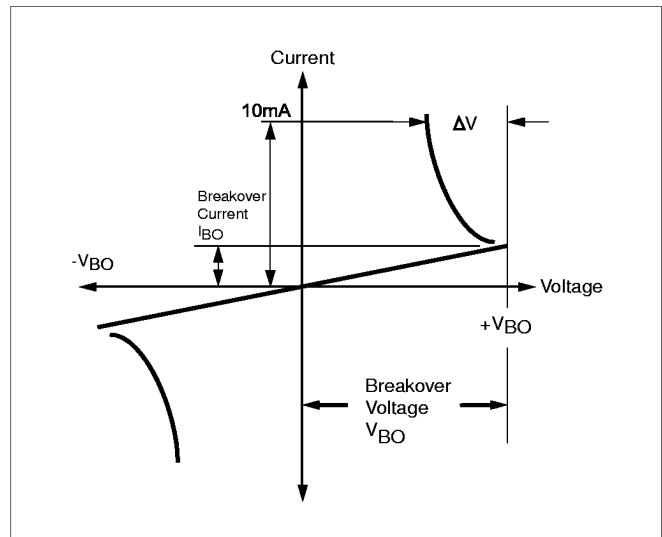
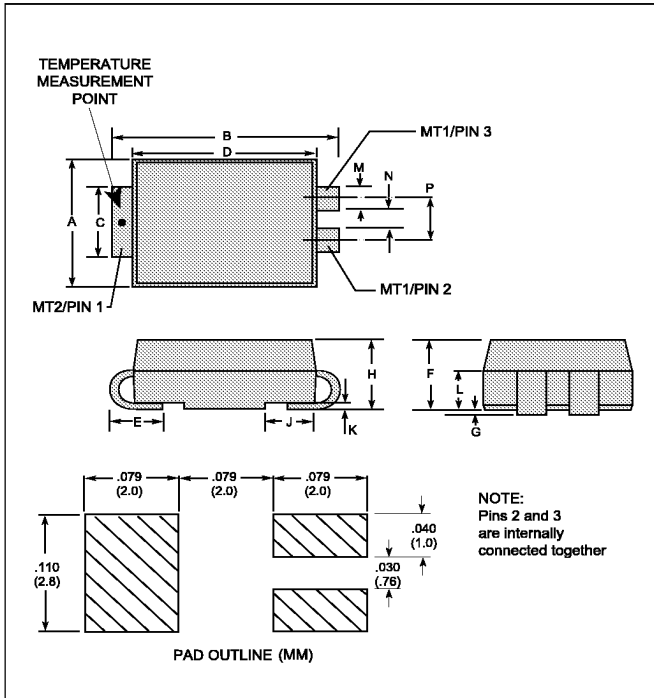


Figure 7: V-I Characteristics

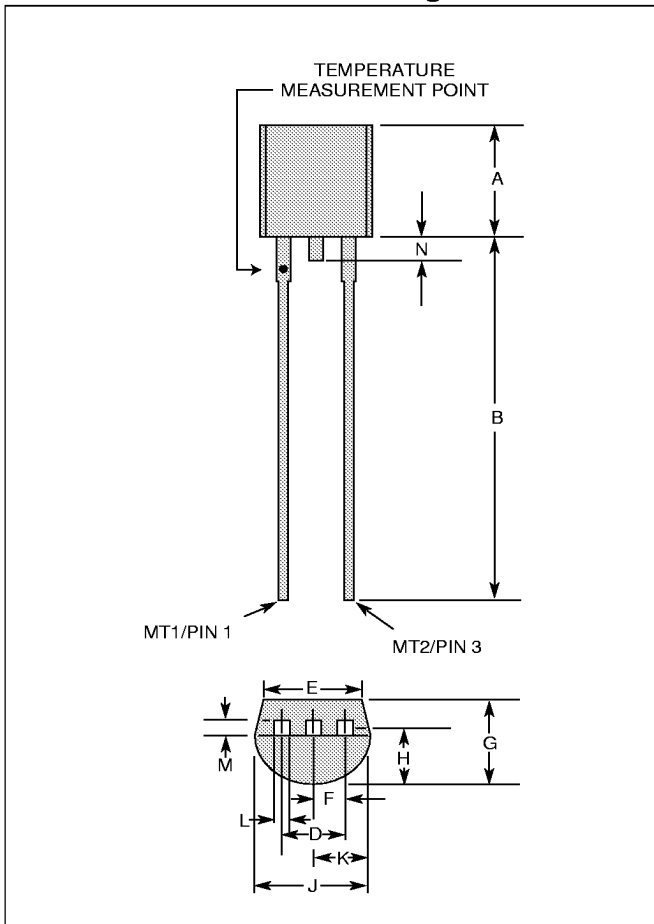


## SMT Package



Dimension	Inches		Millimeters	
	Min	Max	Min	Max
A	0.140	0.155	3.56	3.94
B	0.205	0.220	5.21	5.59
C	0.077	0.083	1.96	2.11
D	0.166	0.180	4.22	4.57
E	0.036	0.056	0.91	1.42
F	0.075	0.082	1.85	2.11
G	0.004	0.008	0.10	0.20
H	0.084	0.094	2.08	2.34
J	0.043	0.053	1.09	1.35
K	0.008	0.012	0.20	0.30
L	0.039	0.049	0.99	1.24
M	0.022	0.028	0.56	0.71
N	0.027	0.033	0.69	0.84
P	0.052	0.058	1.32	1.47

## TO-92 Package



Dimension	Inches		Millimeters	
	Min	Max	Min	Max
A	.176	.196	4.47	4.98
B	.500		12.70	
D	.095	.105	2.41	2.67
E	.150		3.81	
F	.046	.054	1.16	1.37
G	.135	.145	3.43	3.68
H	.088	.096	2.23	2.44
J	.176	.186	4.47	4.73
K	.088	.096	2.23	2.44
L	.013	.019	0.33	0.48
M	.013	.017	0.33	0.43
N		.060		1.52

**NOTE:**

- All leads are insulated from case. Case is electrically non-conductive.