

# Fixed Attenuators (N,BNC,TNC)

## AT-400, AT-500, and AT-600 Series



### ■Features

#### 1.Connector Coupling Portion Variations

Coupling Portion		HRS Series Name
N Type	Plug - Jack※	AT-400 Series
BNC Type	Plug - Jack	AT-500 Series
TNC Type	Plug - Jack	AT-600 Series

※Can also be mated with an S type connector.

#### 2.Small Size and Economical

Value engineering has been liberally applied to the design and construction to make these attenuators small and very economical.

#### 3.High Reliability

These attenuators show stable characteristics for environments of varying temperature, humidity, and gases.

### ■Product Specifications

Ratings	Frequency range	AT-400 Series	DC to 4 GHz	Operating temperature range	-10°C to +65°C		
	Characteristic impedance	50 ohms				Operating relative humidity	95% Max.
	Maximum Input Power	2W					
		AT-500 and 600 Series	DC to 2 GHz				

Item	Standard	Conditions
1.Vibration	No electrical discontinuity of 1 μs or more No damage, cracks, or parts dislocation	Frequency of 10 to 2000 Hz, overall amplitude of 1.52 mm, acceleration of 98 m/s <sup>2</sup> for 2 hours in each of 3 directions
2.Shock		Acceleration of 490 m/s <sup>2</sup> , sine half-wave waveform, 3 cycles in each of the 3 axis
3.Temperature cycle	No damage, cracks, or parts dislocation	Temperature: -55°C → +5°C to +35°C → +85°C → +5°C to +35°C Time: 30 → 15 max. → 30 → 15 max. (Minutes) 200 cycles

●The test method conforms to MIL-STD-202.

### ■Materials

Part	Material	Finish
Connector Body	Brass	Nickel plating
Insulator	PTFE	—
Male contacts	Brass	Gold plating
Female contacts	Beryllium copper	Gold plating
Attenuation element	Metal film	—

### ■Ordering Information

**AT** - **4** **01**

①                      ②                      ③

① AT: Indicates a fixed attenuator	③ Attenuation 01 : 1dB 06 : 6dB
② Indicates the Series Name (Coupling Portion) 4: N plug - jack 5: BNC plug - jack 6: TNC plug - jack	

## ■ Specifications

Part Number	Frequency Range (MHz)	V.S.W.R.(Max)	Attenuation (dB)	Power (W)	Connectors	Weight (g)
AT-401	DC~2000	1.15	1±0.3	2	N-P·J	77
	2000~4000	1.20	1 <sup>+0.5</sup> <sub>-0.3</sub>			
AT-402	DC~2,000	1.15	2±0.3	2	N-P·J	77
	2000~4000	1.20	2 <sup>+0.5</sup> <sub>-0.3</sub>			
AT-403	DC~2,000	1.15	3±0.3	2	N-P·J	77
	2000~4000	1.20	3 <sup>+0.5</sup> <sub>-0.3</sub>			
AT-406	DC~2,000	1.15	6±0.3	2	N-P·J	77
	2000~4000	1.20	6 <sup>+0.5</sup> <sub>-0.3</sub>			
AT-410	DC~2,000	1.15	10±0.5	2	N-P·J	77
	2000~4000	1.20	10 <sup>+0.8</sup> <sub>-0.5</sub>			
AT-420	DC~2,000	1.15	20±0.5	2	N-P·J	77
	2000~4000	1.20	20 <sup>+0.8</sup> <sub>-0.5</sub>			
AT-503	DC~1000	1.15	3±0.3	2	BNC-P·J	25
	1000~2000	1.25				
AT-505	DC~1000	1.15	5±0.3	2	BNC-P·J	25
	1000~2000	1.25				
AT-506	DC~1000	1.15	6±0.3	2	BNC-P·J	25
	1000~2000	1.25				
AT-510	DC~1000	1.15	10±0.5	2	BNC-P·J	25
	1000~2000	1.25				
AT-514	DC~1000	1.15	14±1.2	2	BNC-P·J	25
	1000~2000	1.25				
AT-520	DC~1000	1.15	20±0.5	2	BNC-P·J	25
	1000~2000	1.25				
AT-603	DC~1000	1.15	3±0.3	2	TNC-P·J	29
	1000~2000	1.25				
AT-606	DC~1000	1.15	6±0.3	2	TNC-P·J	29
	1000~2000	1.25				
AT-610	DC~1000	1.15	10±0.5	2	TNC-P·J	29
	1000~2000	1.25				
AT-620	DC~1000	1.15	20±0.5	2	TNC-P·J	29
	1000~2000	1.25				

## External Dimensions

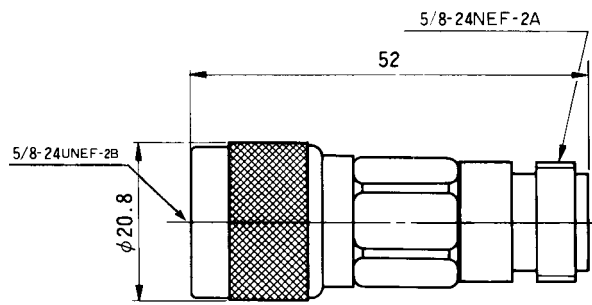

AT-400 Type

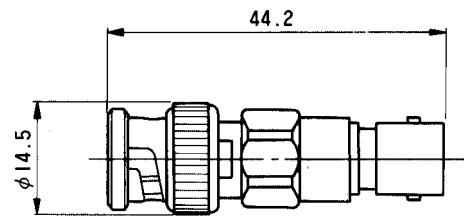

AT-500 Type

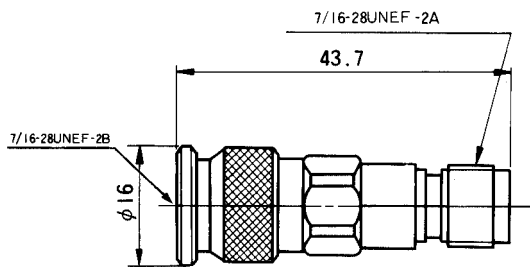

AT-600 Type

## Typical Data

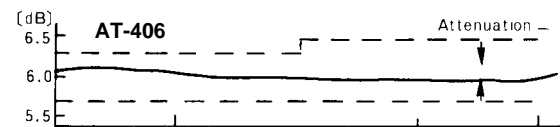
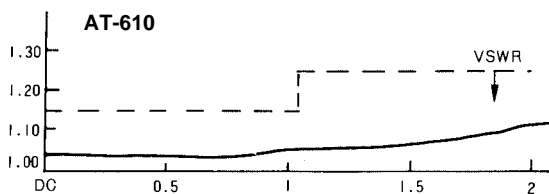
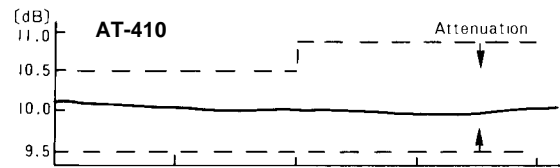
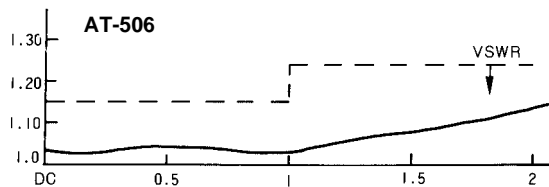
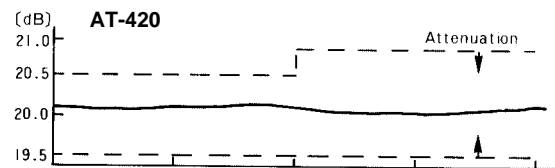
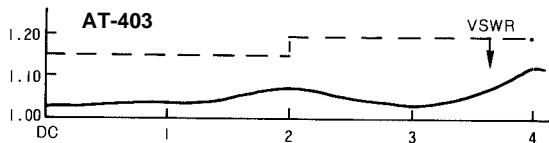

Frequency [GHz] →

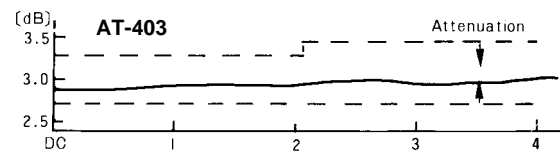

Frequency [GHz] →